

OPTONICA

LED Lighting for Everyone

2022/2023

OPTONICA LED

Who we are:

OPTONICA is a dynamically evolving trade mark, registered in 2011 on the Bulgarian market and a leader in the technologies of the future: LED LIGHTING! We are a team of highly qualified specialists, always perfecting our knowledge and exploring the world of the rapidly developing LED technologies.

Mission:

Our main goal is to serve and cater for the needs of our potential clients and partners with a large variety and quantity of LED products.. We are sure of the quality of our products and guarantee that our services do not have an alternative, thus making us an indicator and an absolute priority in the precision and execution of our work.

Scope of work:

Our company is a main importer and provider of the richest and most versatile range of LED products. We work with established manufacturers, leaders in the field of the industrial LED revolution.

What we offer:

- New generation of LED lighting with a wide range of application: homes, offices, stores, restaurants, hotels, public and administrative buildings, hospitals, schools, gas stations, trade and industrial building, parks, sport halls and stadiums, lawns, garages and parking lots, billboards and commercial constructions.
- Uncompromising quality and up to 5 year warranty.
- Ecological products and 100% recycling.
- Wide range of products and optimum stock.
- Attractive and reliable terms for partners and distributors.
- Professional attitude and responsibility towards every engagement.

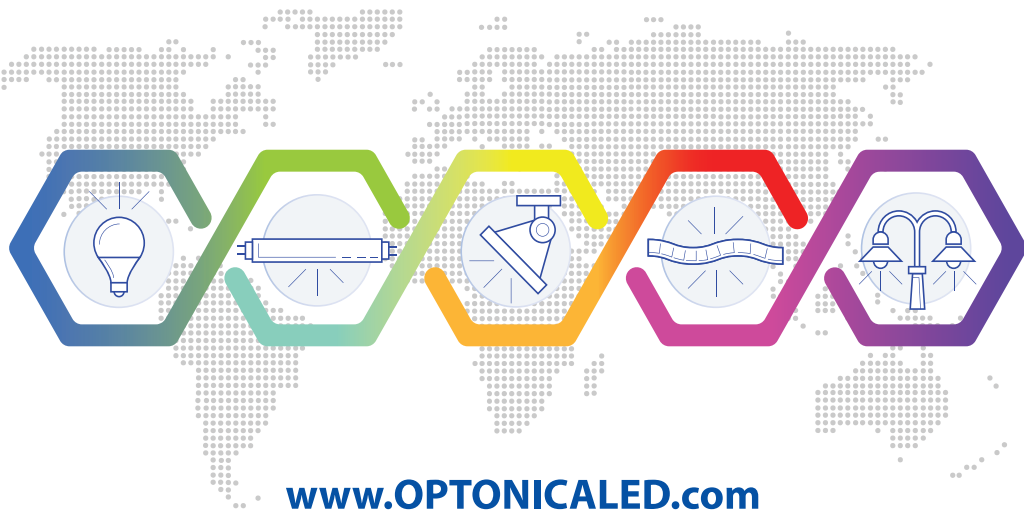

www.OPTONICALED.com

CONTENTS

LED Spots and Bulbs

04-40



Fixtures for Spotlights

41-67



LED T5, T8 Tubes

70-77



LED Fixture and Batten Lights

78-85



LED Emergency Lights

88-91



LED Surface Panels

94-99



LED Ceiling Light & Luxury Pendants

102-129



LED Panels and Mini Panels

132-161



LED Downlights

164-171



LED Strips

174-197



LED Flex Neon & SMD Modules

200-207



LED Power Supplies

210-221



LED Controllers and Accessories

224-243



LED Linear & Track Lights

246-265

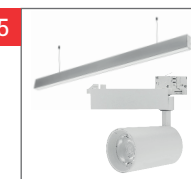

LED Floodlights

268-297



LED Industrial & Street Lights

300-321



LED Wall & Step Lights

324-337

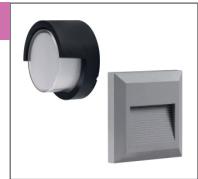

LED Outdoor & Garden Lights

340-361



LED Motion Sensors

364-373



LED Displays and Stage Effects

376-411



Optonica Comfort Products

413-420





Innovative line of half-glass covered bulbs combine the classic retro appearance with modern power-saving technology and creating a cosy ambience in both homes, villa or restaurants and bars.

Features:

- Up to 80% power saving impact
- 2500K warm white light
- Half silver or half golden cover
- E27 socket
- Stylish retro look
- Standard bulb head – A60 or G95

Application:

- Home use on standard sockets
- Outdoor use in enclosed fixtures
- Discrete or additional lighting

LED BULBS GOLDEN GLASS



LED Bulbs PS160 Filament

8W E27 SP8-A1

GOLDEN GLASS

Watts	8W	CRI	Ra>80
Input Voltage	AC : 175-265V	IP Rating	IP20
Flux	810lm	Dimension	ø160x315 mm
Beam Angle	270°	Body Type	PS160
Socket	E27	Dimmable	YES

SKU: 1790 Warm White ■ 1800K 3800156617902

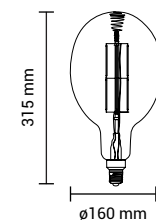

LED Bulbs Filament

4W E27 SP4-A4

HALF GOLDEN GLASS

Watts	4W	CRI	Ra>80
Input Voltage	AC : 175-265V	IP Rating	IP20
Flux	400lm	Dimension	ø95x135 mm
Beam Angle	180°	Body Type	G95
Socket	E27	Dimmable	NO

SKU: 1889 Warm White ■ 2700K 3800156618893

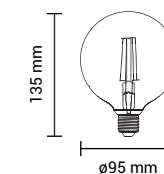

LED Bulbs BD200 Filament

8W E27 SP8-A1

GOLDEN GLASS

Watts	8W	CRI	Ra>80
Input Voltage	AC : 175-265V	IP Rating	IP20
Flux	810lm	Dimension	ø200x410 mm
Beam Angle	270°	Body Type	BD200
Socket	E27	Dimmable	YES

SKU: 1791 Warm White ■ 1800K 3800156617919

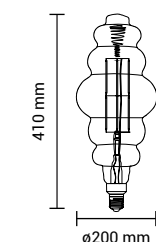

LED Bulbs Filament

4W E27 SP4-A4

HALF SILVER GLASS

Watts	4W	CRI	Ra>80
Input Voltage	AC : 175-265V	IP Rating	IP20
Flux	400lm	Dimension	ø95x135 mm
Beam Angle	180°	Body Type	G95
Socket	E27	Dimmable	NO

SKU: 1887 Warm White ■ 2700K 3800156618879

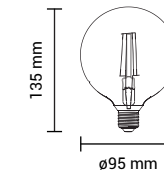
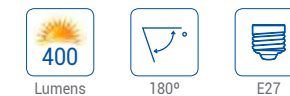

LED Bulbs G200 Filament

8W E27 SP8-A2

GOLDEN GLASS

Watts	8W	CRI	Ra>80
Input Voltage	AC : 175-265V	IP Rating	IP20
Flux	810lm	Dimension	ø200x300 mm
Beam Angle	270°	Body Type	G200
Socket	E27	Dimmable	YES

SKU: 1792 Warm White ■ 1800K 3800156617926

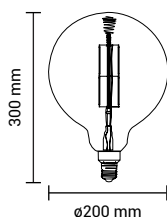

LED Bulbs Filament

7W E27 SP7-A5

HALF GOLDEN GLASS

Watts	7W	CRI	Ra>80
Input Voltage	AC : 175-265V	IP Rating	IP20
Flux	800lm	Dimension	ø95x135 mm
Beam Angle	180°	Body Type	G95
Socket	E27	Dimmable	NO

SKU: 1890 Warm White ■ 2700K 3800156618909

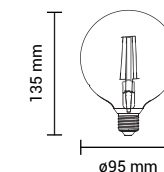
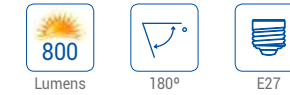

LED Bulbs MS200 Filament

8W E27 SP8-A2

GOLDEN GLASS

Watts	8W	CRI	Ra>80
Input Voltage	AC : 175-265V	IP Rating	IP20
Flux	810lm	Dimension	ø200x210 mm
Beam Angle	270°	Body Type	MS200
Socket	E27	Dimmable	YES

SKU: 1793 Warm White ■ 1800K 3800156617933

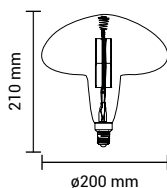

LED Bulbs Filament

7W E27 SP7-A5

HALF SILVER GLASS

Watts	7W	CRI	Ra>80
Input Voltage	AC : 175-265V	IP Rating	IP20
Flux	800lm	Dimension	ø95x135 mm
Beam Angle	180°	Body Type	G95
Socket	E27	Dimmable	NO

SKU: 1888 Warm White ■ 2700K 3800156618886

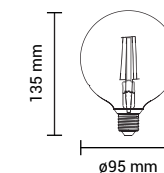
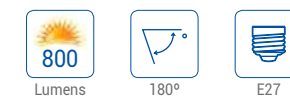



LED Bulbs Filament 4W E27 SP4-A4 HALF GOLDEN GLASS

Watts	4W	CRI	Ra>80
Input Voltage	AC : 175-265V	IP Rating	IP20
Flux	400lm	Dimension	ø60x105 mm
Beam Angle	180°	Body Type	A60
Socket	E27	Dimmable	NO

SKU: 1893 Warm White ■ 2700K 3800156618930



400
Lumens



180°



E27

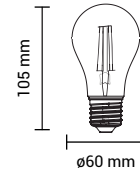

105 mm

ø60 mm



LED Bulbs Filament 4W E27 SP4-A4 HALF SILVER GLASS

Watts	4W	CRI	Ra>80
Input Voltage	AC : 175-265V	IP Rating	IP20
Flux	400lm	Dimension	ø60x105 mm
Beam Angle	180°	Body Type	A60
Socket	E27	Dimmable	NO

SKU: 1879 Warm White ■ 2700K 3800156618794



400
Lumens



180°



E27

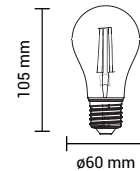

105 mm

ø60 mm



LED Bulbs Filament 7W E27 SP7-A5 HALF GOLDEN GLASS

Watts	7W	CRI	Ra>80
Input Voltage	AC : 175-265V	IP Rating	IP20
Flux	800lm	Dimension	ø60x105 mm
Beam Angle	180°	Body Type	A60
Socket	E27	Dimmable	NO

SKU: 1896 Warm White ■ 2700K 3800156618961



800
Lumens



180°



E27

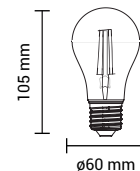

105 mm

ø60 mm



LED Bulbs Filament 7W E27 SP7-A5 HALF SILVER GLASS

Watts	7W	CRI	Ra>80
Input Voltage	AC : 175-265V	IP Rating	IP20
Flux	800lm	Dimension	ø60x105 mm
Beam Angle	180°	Body Type	A60
Socket	E27	Dimmable	NO

SKU: 1880 Warm White ■ 2700K 3800156618800



800
Lumens



180°



E27

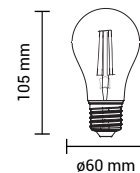

105 mm

ø60 mm

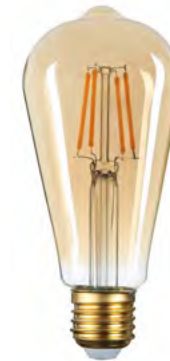

LED ST64 Bulbs Filament 4W E27 SP4-A4 GOLDEN GLASS

Watts	4W	CRI	Ra>80
Input Voltage	AC : 220-240V	IP Rating	IP20
Flux	400lm	Dimension	ø64x140 mm
Beam Angle	270°	Body Type	ST64
Socket	E27	Dimmable	NO

SKU: 1795 Warm White ■ 2500K 3800156617957



400
Lumens



270°



E27

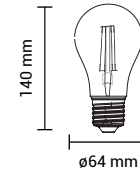

140 mm

ø64 mm

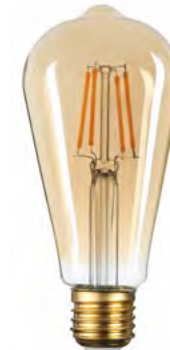

LED ST64 Bulbs Filament 6W E27 SP6-B1 GOLDEN GLASS

Watts	6W	CRI	Ra>80
Input Voltage	AC : 220-240V	IP Rating	IP20
Flux	540lm	Dimension	ø64x140 mm
Beam Angle	270°	Body Type	ST64
Socket	E27	Dimmable	NO

SKU: 1306 Warm White ■ 2500K 3800156613065



540
Lumens



270°



E27

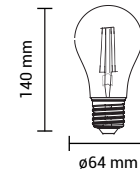

140 mm

ø64 mm



LED ST64 Bulbs Filament 8W E27 SP8-A4 GOLDEN GLASS

Watts	8W	CRI	Ra>80
Input Voltage	AC : 220-240V	IP Rating	IP20
Flux	700lm	Dimension	ø64x140 mm
Beam Angle	270°	Body Type	ST64
Socket	E27	Dimmable	NO

SKU: 1305 Warm White ■ 2500K 3800156613058



700
Lumens



270°



E27

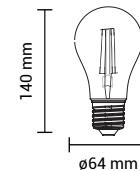

140 mm

ø64 mm



LED ST64 Bulbs Filament 8W E27 SP8-A6 GOLDEN GLASS

Watts	8W	CRI	Ra>80
Input Voltage	AC : 220-240V	IP Rating	IP20
Flux	700lm	Dimension	ø64x140 mm
Beam Angle	270°	Body Type	ST64
Socket	E27	Dimmable	YES

SKU: 1322 Warm White ■ 2500K 3800156613225



700
Lumens



Dimmable



270°



E27

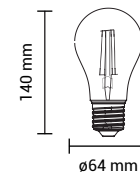

140 mm

ø64 mm



LED A60 Bulbs Filament
4W E27 SP4-A4



Watts	4W	CRI	Ra>80
Input Voltage	AC : 175-265V	IP Rating	IP20
Flux	470lm	Dimension	ø60x100 mm
Beam Angle	300°	Body Type	A60
Socket	E27	Dimmable	NO

SKU: 1857	White Light	6000K	3800156618572
SKU: 1858	Neutral White	4500K	3800156618589
SKU: 1859	Warm White	2700K	3800156618596

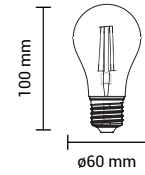

LED A60 Bulbs Filament
4W E27 SP4-A6



Watts	4W	CRI	Ra>80
Input Voltage	AC : 175-265V	IP Rating	IP20
Flux	400lm	Dimension	ø60x106 mm
Beam Angle	300°	Body Type	A60
Socket	E27	Dimmable	YES

SKU: 1899	Warm White	2700K	3800156618992
-----------	------------	-------	---------------

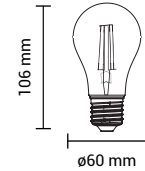

LED A60 Bulbs Filament
5W E27 SP5-A4



Watts	5W	CRI	Ra>80
Input Voltage	AC : 175-265V	IP Rating	IP20
Flux	600lm	Dimension	ø60x106 mm
Beam Angle	300°	Body Type	A60
Socket	E27	Dimmable	NO

SKU: 1854	White Light	6000K	3800156618541
SKU: 1855	Neutral White	4500K	3800156618558
SKU: 1856	Warm White	2700K	3800156618565

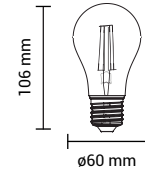

LED A60 Bulbs Filament
6W E27 SP6-B2



Watts	6W	CRI	Ra>80
Input Voltage	AC : 220-240V	IP Rating	IP20
Flux	630lm	Dimension	ø60x105 mm
Beam Angle	300°	Body Type	A60
Socket	E27	Dimmable	NO

SKU: 1308	Neutral White	4000K	3800156613089
SKU: 1309	Warm White	2700K	3800156613096

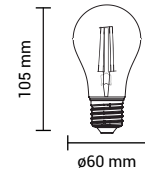

LED A60 Bulbs Filament
8W E27 SP8-A5

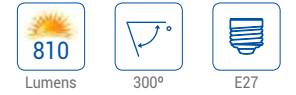

Watts	8W	CRI	Ra>80
Input Voltage	AC : 220-240V	IP Rating	IP20
Flux	810lm	Dimension	ø60x110 mm
Beam Angle	300°	Body Type	A60
Socket	E27	Dimmable	NO

SKU: 1310	White Light	6000K	3800156613102
SKU: 1311	Neutral White	4500K	3800156613119
SKU: 1312	Warm White	2700K	3800156613126

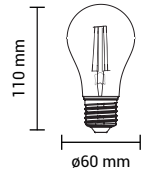

LED A60 Bulbs Filament
8W E27 SP8-A9



Watts	8W	CRI	Ra>80
Input Voltage	AC : 220-240V	IP Rating	IP20
Flux	810lm	Dimension	ø60x110 mm
Beam Angle	300°	Body Type	A60
Socket	E27	Dimmable	YES

SKU: 1323	Warm White	2700K	3800156613232
-----------	------------	-------	---------------

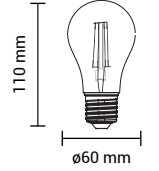

LED A60 Bulbs Filament
8W E27 SP8-A1
GOLDEN GLASS



Watts	8W	CRI	Ra>80
Input Voltage	AC : 220-240V	IP Rating	IP20
Flux	700lm	Dimension	ø60x105 mm
Beam Angle	300°	Body Type	A60
Socket	E27	Dimmable	NO

SKU: 1796	Warm White	2500K	3800156617964
-----------	------------	-------	---------------

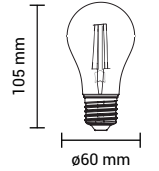

LED A60 Bulbs Filament
8W E27 SP8-A9
GOLDEN GLASS



Watts	8W	CRI	Ra>80
Input Voltage	AC : 220-240V	IP Rating	IP20
Flux	720lm	Dimension	ø60x105 mm
Beam Angle	300°	Body Type	A60
Socket	E27	Dimmable	YES

SKU: 1324	Warm White	2500K	3800156613249
-----------	------------	-------	---------------

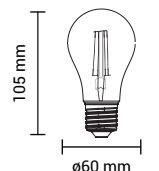



LED A60 Bulbs Filament
10W E27 SP10-A5



Watts	10W	CRI	Ra>80
Input Voltage	AC : 220-240V	IP Rating	IP20
Flux	1350lm	Dimension	ø60x110 mm
Beam Angle	300°	Body Type	A60
Socket	E27	Dimmable	NO

SKU: 1313	White Light	6000K	3800156613133
SKU: 1314	Neutral White	4500K	3800156613140
SKU: 1315	Warm White	2700K	3800156613157

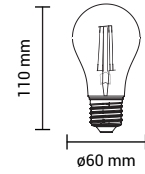

LED A65 Bulbs Filament
12W E27 SP12-A7



Watts	12W	CRI	Ra>80
Input Voltage	AC : 220-240V	IP Rating	IP20
Flux	1500lm	Dimension	ø65x126 mm
Beam Angle	300°	Body Type	A60
Socket	E27	Dimmable	NO

SKU: 1316	White Light	6000K	3800156613164
SKU: 1317	Neutral White	4500K	3800156613171
SKU: 1318	Warm White	2700K	3800156613188

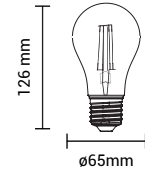

LED A65 Bulbs Filament
14W E27 SP14-A7



Watts	14W	CRI	Ra>80
Input Voltage	AC : 220-240V	IP Rating	IP20
Flux	2000lm	Dimension	ø65x126 mm
Beam Angle	300°	Body Type	A60
Socket	E27	Dimmable	NO

SKU: 1319	White Light	6000K	3800156613195
SKU: 1320	Neutral White	4500K	3800156613201
SKU: 1321	Warm White	2700K	3800156613218

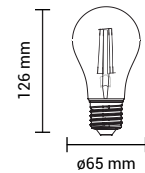

LED G45 Bulbs Filament
2W E27 SP2-A2



Watts	2W	CRI	Ra>80
Input Voltage	AC : 175-265V	IP Rating	IP20
Flux	200lm	Dimension	ø45x78 mm
Beam Angle	300°	Body Type	G45
Socket	E27	Dimmable	NO

SKU: 1864	White Light	6000K	3800156618640
SKU: 1865	Neutral White	4500K	3800156618657
SKU: 1866	Warm White	2700K	3800156618664

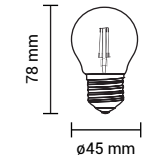

LED G45 Bulbs Filament
4W E27 SP4-A4



Watts	4W	CRI	Ra>80
Input Voltage	AC : 175-265V	IP Rating	IP20
Flux	400lm	Dimension	ø45x78 mm
Beam Angle	300°	Body Type	G45
Socket	E27	Dimmable	NO

SKU: 1867	White Light	6000K	3800156618671
SKU: 1868	Neutral White	4500K	3800156618688
SKU: 1869	Warm White	2700K	3800156618695

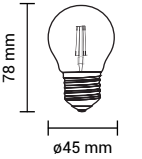

LED G45 Bulbs Filament
4W E27 SP4-A6



Watts	4W	CRI	Ra>80
Input Voltage	AC : 175-265V	IP Rating	IP20
Flux	400lm	Dimension	ø45x78 mm
Beam Angle	300°	Body Type	G45
Socket	E27	Dimmable	NO

SKU: 1325	Warm White	2700K	3800156613256
-----------	------------	-------	---------------

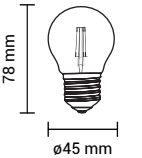

LED G45 Bulbs Filament
4W E27 SP4-A6
GOLDEN GLASS



Watts	4W	CRI	Ra>80
Input Voltage	AC : 175-265V	IP Rating	IP20
Flux	320lm	Dimension	ø45x78 mm
Beam Angle	300°	Body Type	G45
Socket	E27	Dimmable	YES

SKU: 1326	Warm White	2700K	3800156613263
-----------	------------	-------	---------------

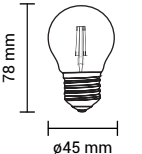

LED G125 Bulbs Filament
4W E27 SP4-A4
GOLDEN GLASS



Watts	4W	CRI	Ra>80
Input Voltage	AC : 220-240V	IP Rating	IP20
Flux	400lm	Dimension	ø95x135 mm
Beam Angle	270°	Body Type	G95
Socket	E27	Dimmable	NO

SKU: 1794	Warm White	2500K	3800156617940
-----------	------------	-------	---------------

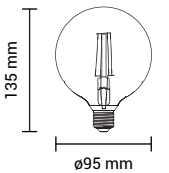



LED G125 Bulbs Filament
4W E27 SP10-A5



Watts	4W	CRI	Ra>80
Input Voltage	AC : 175-265V	IP Rating	IP20
Flux	400lm	Dimension	ø125x165 mm
Beam Angle	300°	Body Type	G125
Socket	E27	Dimmable	NO

SKU: 1863 Neutral White 4500K 3800156618633
SKU: 1862 Warm White 2700K 3800156618626

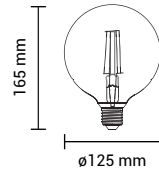

LED G45 Bulbs Filament
4W E14 SP4-A6



Watts	4W	CRI	Ra>80
Input Voltage	AC : 175-265V	IP Rating	IP20
Flux	400lm	Dimension	ø45x78 mm
Beam Angle	300°	Body Type	G45
Socket	E14	Dimmable	YES

SKU: 1417 Warm White 2700K 3800156614178

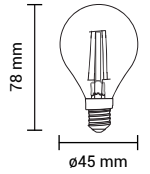

LED G125 Bulbs Filament
6.5W E27 SP10-A5



Watts	6.5W	CRI	Ra>80
Input Voltage	AC : 175-265V	IP Rating	IP20
Flux	810lm	Dimension	ø125x165 mm
Beam Angle	300°	Body Type	G125
Socket	E27	Dimmable	NO

SKU: 1861 Neutral White 4500K 3800156618619
SKU: 1860 Warm White 2700K 3800156618602

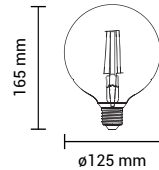

LED G45 Bulbs Filament
4W E14 SP4-A6
GOLDEN GLASS



Watts	4W	CRI	Ra>80
Input Voltage	AC : 175-265V	IP Rating	IP20
Flux	400lm	Dimension	ø45x78 mm
Beam Angle	300°	Body Type	G45
Socket	E14	Dimmable	NO

SKU: 1492 Warm White 2500K 3800156614925

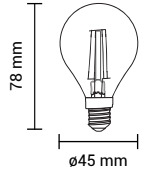

LED G45 Bulbs Filament
2W E14 SP2-A2



Watts	2W	CRI	Ra>80
Input Voltage	AC : 175-265V	IP Rating	IP20
Flux	200lm	Dimension	ø45x78 mm
Beam Angle	300°	Body Type	G45
Socket	E14	Dimmable	NO

SKU: 1474 White Light 6000K 3800156614741
SKU: 1475 Neutral White 4500K 3800156614758
SKU: 1476 Warm White 2700K 3800156614765

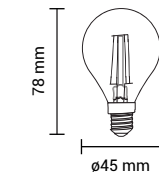

LED G45 Bulbs Filament
4W E14 SP4-A6
GOLDEN GLASS



Watts	4W	CRI	Ra>80
Input Voltage	AC : 175-265V	IP Rating	IP20
Flux	350lm	Dimension	ø45x78 mm
Beam Angle	300°	Body Type	G45
Socket	E14	Dimmable	YES

SKU: 1418 Warm White 2500K 3800156614185

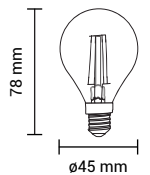

LED G45 Bulbs Filament
4W E14 SP4-A4



Watts	4W	CRI	Ra>80
Input Voltage	AC : 175-265V	IP Rating	IP20
Flux	400lm	Dimension	ø45x78 mm
Beam Angle	300°	Body Type	G45
Socket	E14	Dimmable	NO

SKU: 1477 White Light 6000K 3800156614772
SKU: 1478 Neutral White 4500K 3800156614789
SKU: 1479 Warm White 2700K 3800156614796

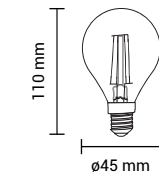

LED R50 Bulbs Filament
5W E14 SP5-A6

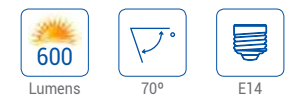

Watts	5W	CRI	Ra>80
Input Voltage	AC : 175-265V	IP Rating	IP20
Flux	600lm	Dimension	ø50x86 mm
Beam Angle	70°	Body Type	R50
Socket	E14	Dimmable	NO

SKU: 1872 Warm White 2700K 3800156618725

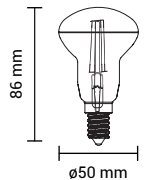



LED C35 Candle Filament

4W E14 SP4-A4

Watts	4W	CRI	Ra>80
Input Voltage	AC : 175-265V	IP Rating	IP20
Flux	400lm	Dimension	ø35x98 mm
Beam Angle	300°	Body Type	C35
Socket	E14	Dimmable	NO

SKU: 1470	White Light	6000K	3800156614703
SKU: 1471	Neutral White	4500K	3800156614710
SKU: 1472	Warm White	2700K	3800156614727

400 Lumens 300° E14

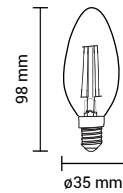

LED C35 Candle Filament

4W E14 SP4-A6

Watts	4W	CRI	Ra>80
Input Voltage	AC : 175-265V	IP Rating	IP20
Flux	400lm	Dimension	ø35x98 mm
Beam Angle	300°	Body Type	C35
Socket	E14	Dimmable	YES

SKU: 1469	Neutral White	4500K	3800156614697
SKU: 1473	Warm White	2700K	3800156614734

400 Lumens Dimmable E14

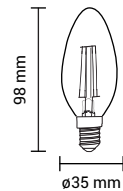

LED C35 Candle Filament

4W E14 SP4-A4
GOLDEN GLASS

Watts	4W	CRI	Ra>80
Input Voltage	AC : 175-265V	IP Rating	IP20
Flux	400lm	Dimension	ø35x98 mm
Beam Angle	300°	Body Type	C35
Socket	E14	Dimmable	NO

SKU: 1490	Warm White	2500K	3800156614901
-----------	------------	-------	---------------

400 Lumens 300° E14

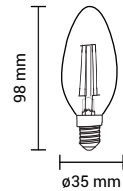

LED C35 Twist Candle Filament

4W E14 SP4-A4

Watts	4W	CRI	Ra>80
Input Voltage	AC : 175-265V	IP Rating	IP20
Flux	400lm	Dimension	ø35x98 mm
Beam Angle	300°	Body Type	C35 Twist
Socket	E14	Dimmable	NO

SKU: 1413	Warm White	2700K	3800156614130
-----------	------------	-------	---------------

400 Lumens 300° E14

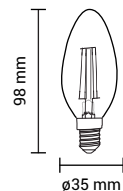

LED C35 Tip Candle Filament

4W E14 SP4-A4

Watts	4W	CRI	Ra>80
Input Voltage	AC : 175-265V	IP Rating	IP20
Flux	400lm	Dimension	ø35x115 mm
Beam Angle	300°	Body Type	C35 Tip
Socket	E14	Dimmable	NO

SKU: 1480	White Light	6000K	3800156614802
SKU: 1481	Neutral White	4500K	3800156614819
SKU: 1482	Warm White	2700K	3800156614826

400 Lumens 300° E14

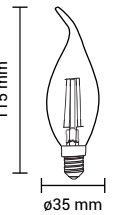

LED C35 Tip Candle Filament

4W E14 SP4-A6

Watts	4W	CRI	Ra>80
Input Voltage	AC : 175-265V	IP Rating	IP20
Flux	400lm	Dimension	ø35x115 mm
Beam Angle	300°	Body Type	C35 Tip
Socket	E14	Dimmable	YES

SKU: 1415	Warm White	2700K	3800156614154
-----------	------------	-------	---------------

400 Lumens Dimmable E14

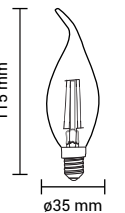

LED C35 Tip Candle Filament

4W E14 SP4-A6
GOLDEN GLASS

Watts	4W	CRI	Ra>80
Input Voltage	AC : 175-265V	IP Rating	IP20
Flux	400lm	Dimension	ø35x120 mm
Beam Angle	300°	Body Type	C35 Tip
Socket	E14	Dimmable	YES

SKU: 1416	Warm White	2500K	3800156614161
-----------	------------	-------	---------------

400 Lumens Dimmable E14

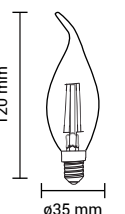

LED C35 Tip Candle Filament

4W E14 SP4-A6
GOLDEN GLASS

Watts	4W	CRI	Ra>80
Input Voltage	AC : 175-265V	IP Rating	IP20
Flux	400lm	Dimension	ø35x120 mm
Beam Angle	300°	Body Type	C35 Tip
Socket	E14	Dimmable	NO

SKU: 1491	Warm White	2500K	3800156614918
-----------	------------	-------	---------------

400 Lumens 300° E14

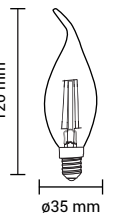



LED C35 Candle Twist Bulbs Filament

4W E14 SP4-A4

Watts	4W	CRI	Ra>80
Input Voltage	AC : 175-265V	IP Rating	IP20
Flux	400lm	Dimension	ø35x115 mm
Beam Angle	300°	Body Type	C35T Twist
Socket	E14	Dimmable	NO

400
Lumens

300°

E14

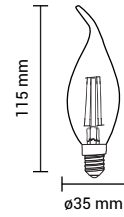

SKU: 1414 Warm White 2700K 3800156614147



LED C35 Candle Filament

6W E14 SP6-B2

Watts	6W	CRI	Ra>80
Input Voltage	AC : 175-265V	IP Rating	IP20
Flux	730lm	Dimension	ø35x98 mm
Beam Angle	300°	Body Type	C35
Socket	E14	Dimmable	NO

730
Lumens

300°

E14

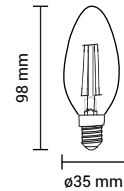

SKU: 1410 White Light 6000K 3800156614109
 SKU: 1411 Neutral White 4500K 3800156614116
 SKU: 1412 Warm White 2700K 3800156614123



LED Bulb A60 Motion Sensor

7W E27 SP9-A4

Watts	7W	CRI	Ra>80
Input Voltage	AC : 220-240V	IP Rating	IP20
Flux	560lm	Dimension	ø60x123 mm
Beam Angle	270°	Body Type	A60
Socket	E27	Dimmable	NO

560
Lumens

270°

E27

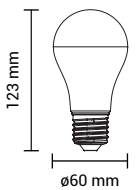

SKU: 1710 White Light 6000K 3800156617100
 SKU: 1711 Neutral White 4500K 3800156617117



LED Bulb A60

9W E27 SP9-A4

Watts	9W	CRI	Ra>80
Input Voltage	AC : 220-240V	IP Rating	IP20
Flux	806lm	Dimension	ø60x108 mm
Beam Angle	270°	Body Type	A60
Socket	E27	Dimmable	YES

806
Lumens

270°

E27

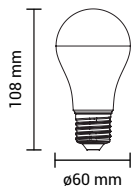

SKU: 1701 White Light 6000K 3800156617018
 SKU: 1702 Neutral White 4500K 3800156617025
 SKU: 1703 Warm White 2700K 3800156617032





LED Bulb A60 High Lumen
9W E27 SP9-A4



Watts	9W	CRI	Ra>80
Input Voltage	AC : 220-240V	IP Rating	IP20
Flux	820lm	Dimension	ø60x108 mm
Beam Angle	270°	Body Type	A60
Socket	E27	Dimmable	NO

SKU: 1774	White Light	6000K	3800156617742
SKU: 1775	Neutral White	4500K	3800156617759
SKU: 1776	Warm White	2700K	3800156617766

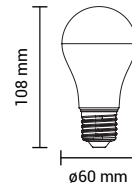

LED Bulbs A60 High Lumen
9W E27 SP9-A4

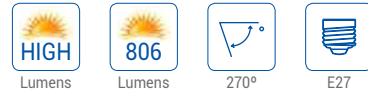

Watts	9W	CRI	Ra>80
Input Voltage	AC : 220-240V	IP Rating	IP20
Flux	806lm	Dimension	ø60x108 mm
Beam Angle	270°	Body Type	A60
Socket	E27	Dimmable	NO

SKU: 1330	White Light	6000K	3800156613300
SKU: 1331	Neutral White	4500K	3800156613317
SKU: 1332	Warm White	2700K	3800156613324

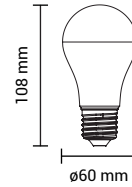

LED Bulb A60
10W E27 SP10-A3



Watts	10W	CRI	Ra>80
Input Voltage	AC : 220-240V	IP Rating	IP20
Flux	806lm	Dimension	ø60x110 mm
Beam Angle	270°	Body Type	A60
Socket	E27	Dimmable	YES

SKU: 1849	White Light	6000K	3800156618497
SKU: 1850	Neutral White	4500K	3800156618503
SKU: 1830	Warm White	2700K	3800156618305

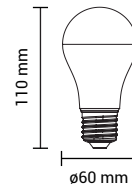

LED Bulb A60
11W E27 SP11-A1



Watts	11W	CRI	Ra>80
Input Voltage	AC : 220-240V	IP Rating	IP20
Flux	1055lm	Dimension	ø60x110mm
Beam Angle	270°	Body Type	A60
Socket	E27	Dimmable	YES

SKU: 1704	White Light	6000K	3800156617049
SKU: 1705	Neutral White	4500K	3800156617056
SKU: 1706	Warm White	2700K	3800156617063

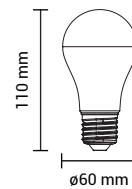

LED Bulb A60 High Lumen
11W E27 SP11-A1

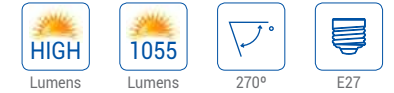

Watts	11W	CRI	Ra>80
Input Voltage	AC : 220-240V	IP Rating	IP20
Flux	1055lm	Dimension	ø60x110mm
Beam Angle	270°	Body Type	A60
Socket	E27	Dimmable	NO

SKU: 1777	White Light	6000K	3800156617773
SKU: 1778	Neutral White	4500K	3800156617780
SKU: 1779	Warm White	2700K	3800156617797

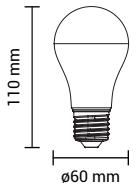

LED Bulb A60 High Lumen
11W E27 SP11-A1

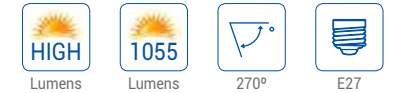

Watts	11W	CRI	Ra>80
Input Voltage	AC : 220-240V	IP Rating	IP20
Flux	1055lm	Dimension	ø60x108 mm
Beam Angle	270°	Body Type	A60
Socket	E27	Dimmable	NO

SKU: 1333	White Light	6000K	3800156613331
SKU: 1334	Neutral White	4500K	3800156613348
SKU: 1335	Warm White	2700K	3800156613355

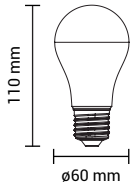

LED Bulb A60
12W E27 SP12-A5



Watts	12W	CRI	Ra>80
Input Voltage	AC : 175-265V	IP Rating	IP20
Flux	1055lm	Dimension	ø60x120 mm
Beam Angle	270°	Body Type	A60
Socket	E27	Dimmable	YES

SKU: 1851	White Light	6000K	3800156618510
SKU: 1852	Neutral White	4500K	3800156618527
SKU: 1834	Warm White	2700K	3800156618343

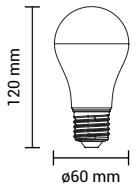

LED Bulb A65
15W E27 SP15-A6



Watts	15W	CRI	Ra>80
Input Voltage	AC : 175-265V	IP Rating	IP20
Flux	1500lm	Dimension	ø65x122 mm
Beam Angle	270°	Body Type	A65
Socket	E27	Dimmable	NO

SKU: 1835	White Light	6000K	3800156618350
SKU: 1836	Neutral White	4500K	3800156618367
SKU: 1837	Warm White	2700K	3800156618374

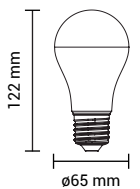



LED Bulb A70
18W E27 SP18-A1



Watts	18W	CRI	Ra>80
Input Voltage	AC : 175-265V	IP Rating	IP20
Flux	1820lm	Dimension	ø70x134 mm
Beam Angle	270°	Body Type	A70
Socket	E27	Dimmable	NO

SKU: 1881	White Light	6000K	3800156618817
SKU: 1882	Neutral White	4500K	3800156618824
SKU: 1883	Warm White	2700K	3800156618831

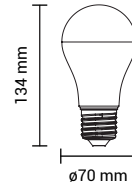

LED Bulb A65
19W E27 SP20-A1



Watts	19W	CRI	Ra>80
Input Voltage	AC : 220-240V	IP Rating	IP20
Flux	2000lm	Dimension	ø65x138 mm
Beam Angle	270°	Body Type	A65
Socket	E27	Dimmable	NO

SKU: 1707	White Light	6000K	3800156617070
SKU: 1708	Neutral White	4500K	3800156617087
SKU: 1709	Warm White	2700K	3800156617094

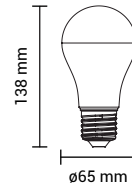

LED Bulb G95
12W E27 SP12-A5



Watts	12W	CRI	Ra>80
Input Voltage	AC : 170-265V	IP Rating	IP20
Flux	1050lm	Dimension	ø95x138 mm
Beam Angle	270°	Body Type	G95
Socket	E27	Dimmable	YES

SKU: 1844	Warm White	2700K	3800156618442
-----------	------------	-------	---------------

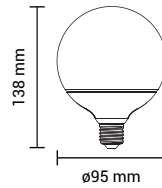

LED Bulb G95
12W E27 SP12-A5



Watts	12W	CRI	Ra>80
Input Voltage	AC : 175-265V	IP Rating	IP20
Flux	1155lm	Dimension	ø95x138 mm
Beam Angle	270°	Body Type	A60
Socket	E27	Dimmable	NO

SKU: 1841	White Light	6000K	3800156618411
SKU: 1842	Neutral White	4500K	3800156618428
SKU: 1843	Warm White	2700K	3800156618435

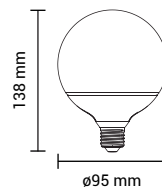

LED Bulb G120
15W E27 SP15-A6



Watts	15W	CRI	Ra>80
Input Voltage	AC : 175-265V	IP Rating	IP20
Flux	1500lm	Dimension	ø120x155 mm
Beam Angle	270°	Body Type	G120
Socket	E27	Dimmable	NO

SKU: 1845	White Light	6000K	3800156618459
SKU: 1846	Neutral White	4500K	3800156618466
SKU: 1847	Warm White	2700K	3800156618473

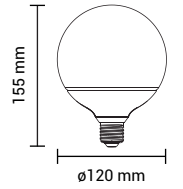

LED Bulb G120
18W E27 SP18-A1



Watts	18W	CRI	Ra>80
Input Voltage	AC : 175-265V	IP Rating	IP20
Flux	1820lm	Dimension	ø125x172 mm
Beam Angle	270°	Body Type	120
Socket	E27	Dimmable	NO

SKU: 1884	White Light	6000K	3800156618848
SKU: 1885	Neutral White	4500K	3800156618855
SKU: 1886	Warm White	2700K	3800156618862

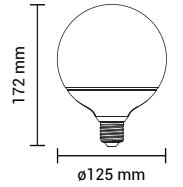

LED Bulb Mosquito Zapper
8W+2W E27 SP8-A3



Watts	8W+2W Zapper	CRI	Ra>80
Input Voltage	AC : 100-265V	IP Rating	IP20
Flux	640lm	Dimension	ø95x172 mm
Beam Angle	180°	Body Type	G95
Socket	E27	Dimmable	NO

SKU: 1819	Neutral White	4500K	3800156618466
-----------	---------------	-------	---------------

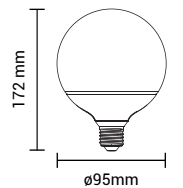

LED Bulb G63
6W E27 SP6-A8



Watts	6W	CRI	Ra>80
Input Voltage	AC : 220-240V	IP Rating	IP20
Flux	480lm	Dimension	ø63x100 mm
Beam Angle	200°	Body Type	A60
Socket	E27	Dimmable	NO

SKU: 1876	White Light	6000K	3800156618763
SKU: 1877	Neutral White	4500K	3800156618770
SKU: 1878	Warm White	2700K	3800156618787

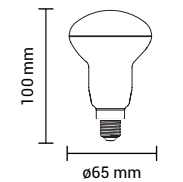



LED Bulb G45
4W E27 SP4-A5

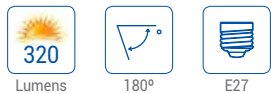

Watts	4W	CRI	Ra>80
Input Voltage	AC : 175-265V	IP Rating	IP20
Flux	320lm	Dimension	ø45x75 mm
Beam Angle	180°	Body Type	G45
Socket	E27	Dimmable	NO

SKU: 1838	White Light	6000K	3800156618381
SKU: 1839	Neutral White	4500K	3800156618398
SKU: 1840	Warm White	2700K	3800156618404

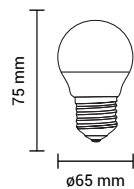

LED Bulb G45
6W E27 SP6-A8

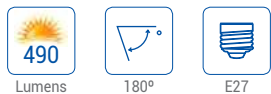

Watts	6W	CRI	Ra>80
Input Voltage	AC : 220-240V	IP Rating	IP20
Flux	490lm	Dimension	ø45x75 mm
Beam Angle	180°	Body Type	G45
Socket	E27	Dimmable	NO

SKU: 1816	White Light	6000K	3800156618169
SKU: 1817	Neutral White	4500K	3800156618176
SKU: 1818	Warm White	2700K	3800156618183

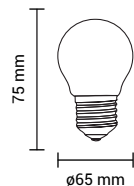

LED Bulb G45
8.5W E27 SP9-A3



Watts	8.5W	CRI	Ra>80
Input Voltage	AC : 175-265V	IP Rating	IP20
Flux	800lm	Dimension	ø45x75 mm
Beam Angle	180°	Body Type	G45
Socket	E27	Dimmable	NO

SKU: 1813	White Light	6000K	3800156618138
SKU: 1814	Neutral White	4500K	3800156618145
SKU: 1815	Warm White	2700K	3800156618152

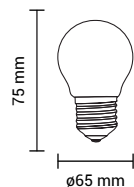

LED Spot PAR30
30W E27 SP25-A2

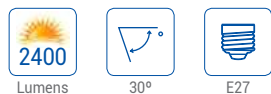

Watts	30W	CRI	Ra>80
Input Voltage	AC : 220-240V	IP Rating	IP20
Flux	2400lm	Dimension	ø95x130 mm
Beam Angle	30°	Body Type	PAR30
Socket	E27	Dimmable	NO

SKU: 1528	White Light	6000K	3800156615281
SKU: 1529	Neutral White	4500K	3800156615298
SKU: 1530	Warm White	2700K	3800156615304

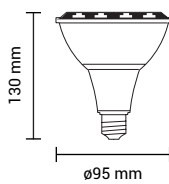

LED Candle C37
4W E14 SP4-A5

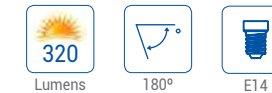

Watts	4W	CRI	Ra>80
Input Voltage	AC : 175-265V	IP Rating	IP20
Flux	320lm	Dimension	ø37x100 mm
Beam Angle	180°	Body Type	C37
Socket	E14	Dimmable	NO

SKU: 1457	White Light	6000K	3800156614574
SKU: 1458	Neutral White	4500K	3800156614581
SKU: 1459	Warm White	2700K	3800156614598

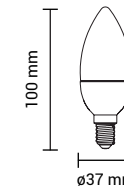

LED Candle C37
6W E14 SP6-A8

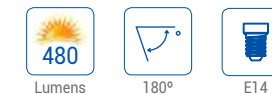

Watts	6W	CRI	Ra>80
Input Voltage	AC : 220-240V	IP Rating	IP20
Flux	480lm	Dimension	ø37x100 mm
Beam Angle	180°	Body Type	C37
Socket	E14	Dimmable	NO

SKU: 1460	White Light	6000K	3800156614604
SKU: 1461	Neutral White	4500K	3800156614611
SKU: 1462	Warm White	2700K	3800156614628

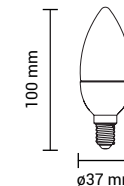

LED Candle C37
6W E14 SP6-A5

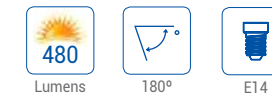

Watts	6W	CRI	Ra>80
Input Voltage	AC : 175-265V	IP Rating	IP20
Flux	480lm	Dimension	ø37x100 mm
Beam Angle	180°	Body Type	C37
Socket	E14	Dimmable	YES

SKU: 1464	White Light	6000K	3800156614642
SKU: 1465	Neutral White	4500K	3800156614659
SKU: 1463	Warm White	2700K	3800156614635

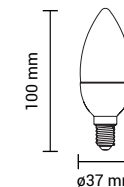

LED Candle C37
6W E14 SP6-A8

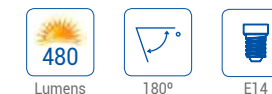

Watts	6W	CRI	Ra>80
Input Voltage	AC : 175-265V	IP Rating	IP20
Flux	480lm	Dimension	ø37x100 mm
Beam Angle	180°	Body Type	C37
Socket	E14	Dimmable	NO

SKU: 1419	White Light	6000K	3800156614192
SKU: 1420	Neutral White	4500K	3800156614208
SKU: 1421	Warm White	2700K	3800156614215

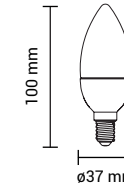



LED Candle C37
8.5W E14 SP9-A3



Watts	8.5W	CRI	Ra>80
Input Voltage	AC : 175-265V	IP Rating	IP20
Flux	806lm	Dimension	ø37x100 mm
Beam Angle	180°	Body Type	C37
Socket	E14	Dimmable	NO

SKU: 1483	White Light	6000K	3800156614833
SKU: 1484	Neutral White	4500K	3800156614840
SKU: 1485	Warm White	2700K	3800156614857

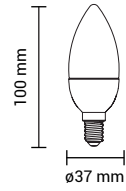

LED Candle C37 Tip
6W E14 SP6-A8



Watts	6W	CRI	Ra>80
Input Voltage	AC : 175-265V	IP Rating	IP20
Flux	490lm	Dimension	ø37x125 mm
Beam Angle	180°	Body Type	C37 Tip
Socket	E14	Dimmable	NO

SKU: 1466	White Light	6000K	3800156614666
SKU: 1467	Neutral White	4500K	3800156614673
SKU: 1468	Warm White	2700K	3800156614680

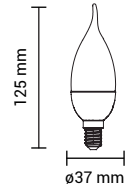

LED Bulb R39
4W E14 SP4-A5



Watts	8.5W	CRI	Ra>80
Input Voltage	AC : 175-265V	IP Rating	IP20
Flux	300lm	Dimension	ø39x68 mm
Beam Angle	200°	Body Type	R39
Socket	E14	Dimmable	NO

SKU: 1487	White Light	6000K	3800156614833
SKU: 1488	Neutral White	4500K	3800156614840
SKU: 1489	Warm White	2700K	3800156614857

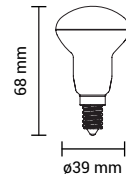

LED Bulb R50
6W E14 SP6-A8



Watts	6W	CRI	Ra>80
Input Voltage	AC : 175-265V	IP Rating	IP20
Flux	450lm	Dimension	ø50x85 mm
Beam Angle	200°	Body Type	R50
Socket	E14	Dimmable	NO

SKU: 1438	White Light	6000K	3800156614833
SKU: 1439	Neutral White	4500K	3800156614840
SKU: 1440	Warm White	2700K	3800156614857

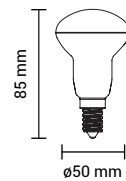

LED Bulb P45
4W E14 SP4-A5



Watts	4W	CRI	Ra>80
Input Voltage	AC : 220-240V	IP Rating	IP20
Flux	320lm	Dimension	ø45x78 mm
Beam Angle	240°	Body Type	P45
Socket	E14	Dimmable	NO

SKU: 1451	White Light	6000K	3800156614512
SKU: 1452	Neutral White	4500K	3800156614529
SKU: 1453	Warm White	2700K	3800156614536

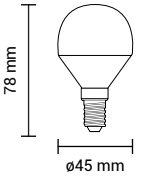

LED Bulb P45
6W E14 SP6-A8



Watts	6W	CRI	Ra>80
Input Voltage	AC : 220-240V	IP Rating	IP20
Flux	480lm	Dimension	ø45x78 mm
Beam Angle	240°	Body Type	P45
Socket	E14	Dimmable	NO

SKU: 1447	White Light	6000K	3800156614475
SKU: 1448	Neutral White	4500K	3800156614482
SKU: 1449	Warm White	2700K	3800156614499

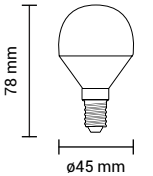

LED Bulb P45
6W E14 SP6-A8



Watts	6W	CRI	Ra>80
Input Voltage	AC : 220-240V	IP Rating	IP20
Flux	480lm	Dimension	ø45x78 mm
Beam Angle	240°	Body Type	P45
Socket	E14	Dimmable	YES

SKU: 1496	White Light	6000K	3800156614963
SKU: 1497	Neutral White	4500K	3800156614970
SKU: 1498	Warm White	2700K	3800156614987

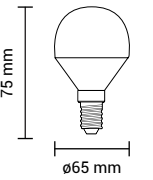

LED Bulb P45
8.5W E14 SP9-A3



Watts	8.5W	CRI	Ra>80
Input Voltage	AC : 175-265V	IP Rating	IP20
Flux	800lm	Dimension	ø45x78 mm
Beam Angle	240°	Body Type	P45
Socket	E14	Dimmable	NO

SKU: 1493	White Light	6000K	3800156614932
SKU: 1494	Neutral White	4500K	3800156614949
SKU: 1495	Warm White	2700K	3800156614956

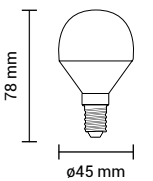



LED Bulb A60 High Lumen
9W B22 SP9-A4



Watts	9W	CRI	Ra>80
Input Voltage	AC : 220-240V	IP Rating	IP20
Flux	820lm	Dimension	ø60x110 mm
Beam Angle	270°	Body Type	A60
Socket	B22	Dimmable	NO

SKU: 1918	White Light	6000K	3800156619180
SKU: 1919	Neutral White	4500K	3800156619197
SKU: 1920	Warm White	2700K	3800156619203

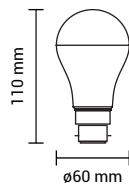

LED Bulb A60
10W B22 SP10-A3



Watts	10W	CRI	Ra>80
Input Voltage	AC : 220-240V	IP Rating	IP20
Flux	800lm	Dimension	ø60x110 mm
Beam Angle	270°	Body Type	A60
Socket	B22	Dimmable	YES

SKU: 1910	Warm White	2700K	3800156619104
-----------	------------	-------	---------------

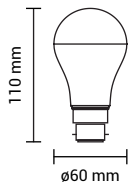

LED Bulb A60 High Lumen
11W B22 SP11-A1



Watts	11W	CRI	Ra>80
Input Voltage	AC : 220-240V	IP Rating	IP20
Flux	1055lm	Dimension	ø60x110 mm
Beam Angle	270°	Body Type	A60
Socket	B22	Dimmable	NO

SKU: 1921	White Light	6000K	3800156619210
SKU: 1922	Neutral White	4500K	3800156619227
SKU: 1923	Warm White	2700K	3800156619234

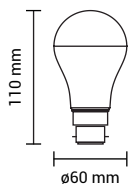

LED Bulb A65
12W B22 SP12-A5



Watts	12W	CRI	Ra>80
Input Voltage	AC : 220-240V	IP Rating	IP20
Flux	960lm	Dimension	ø65x110 mm
Beam Angle	270°	Body Type	A65
Socket	B22	Dimmable	YES

SKU: 1914	Warm White	2700K	3800156619142
-----------	------------	-------	---------------

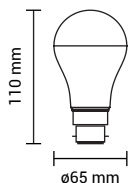

LED Bulb A65
15W B22 SP15-A6



Watts	15W	CRI	Ra>80
Input Voltage	AC : 220-240V	IP Rating	IP20
Flux	1200lm	Dimension	ø65x110 mm
Beam Angle	270°	Body Type	A65
Socket	B22	Dimmable	NO

SKU: 1915	White Light	6000K	3800156619180
SKU: 1916	Neutral White	4500K	3800156619197
SKU: 1917	Warm White	2700K	3800156619203

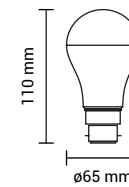

LED Candle C37
6W B22 SP6-A8

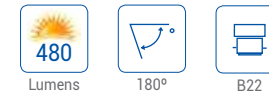

Watts	6W	CRI	Ra>80
Input Voltage	AC : 220-240V	IP Rating	IP20
Flux	480lm	Dimension	ø37x90 mm
Beam Angle	180°	Body Type	C37
Socket	B22	Dimmable	NO

SKU: 1950	White Light	6000K	3800156619500
SKU: 1951	Neutral White	4500K	3800156619517
SKU: 1952	Warm White	2700K	3800156619524

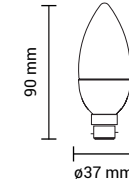

LED Candle C37
6W B22 SP6-A9



Watts	6W	CRI	Ra>80
Input Voltage	AC : 220-240V	IP Rating	IP20
Flux	480lm	Dimension	ø37x90 mm
Beam Angle	180°	Body Type	C37
Socket	B22	Dimmable	YES

SKU: 1953	Warm White	2700K	3800156619531
-----------	------------	-------	---------------

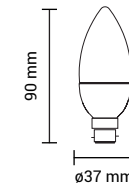

LED Candle C37
6W B15 SP6-A8



Watts	6W	CRI	Ra>80
Input Voltage	AC : 220-240V	IP Rating	IP20
Flux	480lm	Dimension	ø37x90 mm
Beam Angle	180°	Body Type	C37
Socket	B15	Dimmable	NO

SKU: 1954	White Light	6000K	3800156619548
SKU: 1955	Neutral White	4500K	3800156619555
SKU: 1956	Warm White	2700K	3800156619562

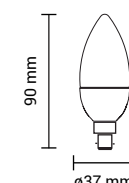

LED Spotlight G4
2W SMD SP2-A1



Watts	2W	CRI	Ra>80
Input Voltage	AC;DC 12V	IP Rating	IP20
Flux	170lm	Dimension	ø10x30 mm
Beam Angle	360°	Material	Plastic
Socket	G4	Dimmable	NO

SKU: 1615	White Light	6000K	3800156616158
SKU: 1616	Neutral White	4500K	3800156616165
SKU: 1617	Warm White	2700K	3800156616172

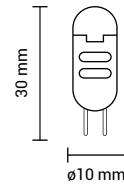

LED Spotlight G9
3.5W SMD SP4-A7



Watts	3.5W	CRI	Ra>80
Input Voltage	AC:220-240V	IP Rating	IP20
Flux	400lm	Dimension	ø16x50 mm
Beam Angle	360°	Material	Ceramic
Socket	G9	Dimmable	NO

SKU: 1651	White Light	6000K	3800156616516
SKU: 1652	Neutral White	4500K	3800156616523
SKU: 1653	Warm White	2800K	3800156616530

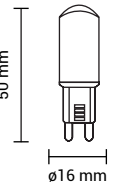

LED Spotlight G4/MR11
3W SMD SP3-A2



Watts	3W	CRI	Ra>80
Input Voltage	AC;DC 12V	IP Rating	IP20
Flux	210lm	Dimension	ø35x45 mm
Beam Angle	38°	Material	Plastic
Socket	G4	Dimmable	NO

SKU: 1066	White Light	6000K	3800156610668
SKU: 1067	Neutral White	4500K	3800156610675
SKU: 1068	Warm White	2700K	3800156610682

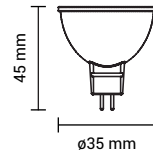

LED Spotlight G9
4W SMD SP4-A7



Watts	4W	CRI	Ra>80
Input Voltage	AC:220-240V	IP Rating	IP20
Flux	400lm	Dimension	ø16x50 mm
Beam Angle	360°	Material	Ceramic
Socket	G9	Dimmable	YES

SKU: 1654	White Light	6000K	3800156616547
SKU: 1655	Neutral White	4500K	3800156616554
SKU: 1656	Warm White	2800K	3800156616561

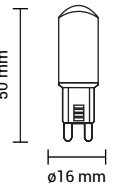

LED Spotlight G9
3W SMD SP3-A1



Watts	3W	CRI	Ra>80
Input Voltage	AC:170-265V	IP Rating	IP20
Flux	220lm	Dimension	ø16x48 mm
Beam Angle	360°	Material	Plastic
Socket	G9	Dimmable	NO

SKU: 1638	White Light	6000K	3800156616387
SKU: 1639	Neutral White	4500K	3800156616394
SKU: 1640	Warm White	2800K	3800156616400

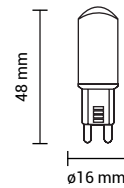

LED Spotlight G5.3
15W AR111 SP15-A3



Watts	15W	CRI	Ra>80
Input Voltage	AC ; DC 12V	IP Rating	IP20
Flux	1050lm	Dimension	ø111x58 mm
Beam Angle	30°	Material	Plastic
Socket	G5.3	Dimmable	NO

SKU: 1517	Neutral White	4500K	3800156615175
SKU: 1516	Warm White	2700K	3800156615168

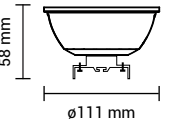

EPISTAR Chips

LED Spotlight G9
6W SMD SP6-A2



Watts	6W	CRI	Ra>80
Input Voltage	AC:170-265V	IP Rating	IP20
Flux	550lm	Dimension	ø18x64 mm
Beam Angle	360°	Material	Plastic
Socket	G9	Dimmable	YES

SKU: 1644	White Light	6000K	3800156616448
SKU: 1645	Neutral White	4500K	3800156616455
SKU: 1646	Warm White	2800K	3800156616462

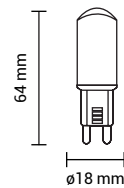

LED Spotlight G5.3
15W AR111 SP15-A4



Watts	15W	CRI	Ra>80
Input Voltage	AC ; DC 12V	IP Rating	IP20
Flux	1050lm	Dimension	ø111x58 mm
Beam Angle	120°	Material	Plastic
Socket	G5.3	Dimmable	NO

SKU: 1519	Neutral White	4500K	3800156615199
SKU: 1518	Warm White	2700K	3800156615182

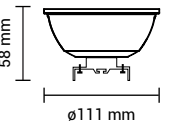

EPISTAR Chips

LED Spotlight GU10
9W AR111 SP9-A1



Watts	9W	CRI	Ra>80
Input Voltage	AC: 170-265V	IP Rating	IP20
Flux	820lm	Dimension	ø111x58 mm
Beam Angle	120°	Material	Plastic
Socket	GU10	Dimmable	NO

SKU: 1531 Neutral White 4500K 3800156615311
SKU: 1532 Warm White 2700K 3800156615328

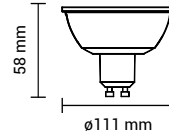

LED Spotlight GU10
15W AR111 SP15-A1



Watts	15W	CRI	Ra>80
Input Voltage	AC: 170-265V	IP Rating	IP20
Flux	1200lm	Dimension	ø111x58 mm
Beam Angle	30°	Material	Plastic
Socket	GU10	Dimmable	NO

SKU: 1533 Neutral White 4500K 3800156615335
SKU: 1534 Warm White 2700K 3800156615342

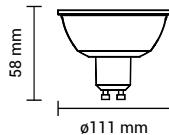

LED Spotlight GU10
15W AR111 SP15-A2



Watts	15W	CRI	Ra>80
Input Voltage	AC: 170-265V	IP Rating	IP20
Flux	1100lm	Dimension	ø111x58 mm
Beam Angle	30°	Material	Plastic
Socket	GU10	Dimmable	YES

SKU: 1535 Neutral White 4500K 3800156615359
SKU: 1536 Warm White 2700K 3800156615366

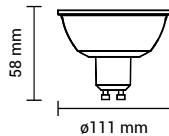

LED Spotlight GX53
7W Recessed SP7-A1



Watts	7W	CRI	Ra>80
Input Voltage	AC:220-240V	IP Rating	IP20
Flux	560lm	Dimension	ø74x25 mm
Beam Angle	180°	Material	Plastic
Socket	GX53	Dimmable	NO

SKU: 1541 White Light 6000K 3800156615410
SKU: 1542 Neutral White 4500K 3800156615427
SKU: 1543 Warm White 2800K 3800156615434

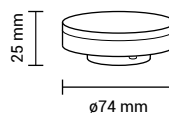

LED Spotlight GU5.3/MR16
5W SMD SP5-A2



Watts	5W	CRI	Ra>80
Input Voltage	DC : 12V	IP Rating	IP20
Flux	400lm	Dimension	ø50x47 mm
Beam Angle	110°	Material	Plastic
Socket	GU5.3	Dimmable	NO

SKU: 1191 White Light 6000K 3800156611917
SKU: 1192 Neutral White 4500K 3800156611924
SKU: 1193 Warm White 2700K 3800156611931

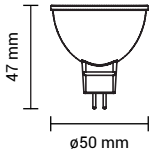
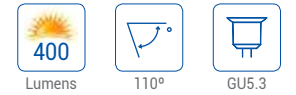

LED Spotlight GU5.3/MR16
7W SMD SP7-A2



Watts	7W	CRI	Ra>80
Input Voltage	DC : 12V	IP Rating	IP20
Flux	600lm	Dimension	ø50x47 mm
Beam Angle	110°	Material	Plastic
Socket	GU5.3	Dimmable	NO

SKU: 1194 White Light 6000K 3800156611948
SKU: 1195 Neutral White 4500K 3800156611955
SKU: 1196 Warm White 2700K 3800156611962

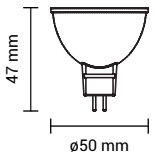
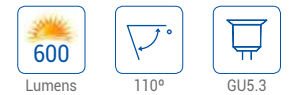

LED Spotlight GU5.3/MR16
4W COB SP4-A1



Watts	4W	CRI	Ra>80
Input Voltage	AC;DC 12V	IP Rating	IP20
Flux	320lm	Dimension	ø50x55 mm
Beam Angle	50°	Material	Plastic
Socket	GU5.3	Dimmable	NO

SKU: 1163 White Light 6000K 3800156611634
SKU: 1167 Neutral White 4500K 3800156611672
SKU: 1164 Warm White 2700K 3800156611641

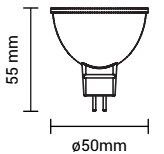
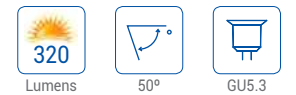

LED Spotlight GU5.3/MR16
6W COB SP7-A2



Watts	6W	CRI	Ra>80
Input Voltage	AC;DC 12V	IP Rating	IP20
Flux	400lm	Dimension	ø50x55 mm
Beam Angle	50°	Material	Plastic
Socket	GU5.3	Dimmable	NO

SKU: 1168 White Light 6000K 3800156611689
SKU: 1169 Neutral White 4500K 3800156611696
SKU: 1170 Warm White 2700K 3800156611702

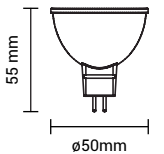
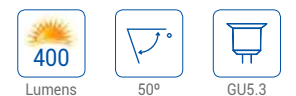



LED Spotlight GU10
4W COB SP4-A2

Watts	4W	CRI	Ra>80
Input Voltage	AC : 220-240V	IP Rating	IP20
Flux	320lm	Dimension	ø50x55 mm
Beam Angle	50°	Body Color	White
Socket	GU10	Dimmable	NO

SKU: 1957	White Light	6000K	3800156619579
SKU: 1958	Neutral White	4500K	3800156619586
SKU: 1959	Warm White	2700K	3800156619593

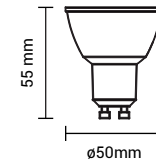

LED Spotlight GU10
4W COB SP4-A2

Watts	4W	CRI	Ra>80
Input Voltage	AC : 220-240V	IP Rating	IP20
Flux	320lm	Dimension	ø50x60 mm
Beam Angle	50°	Body Color	Gray
Socket	GU10	Dimmable	NO

SKU: 1263	White Light	6000K	3800156612631
SKU: 1264	Neutral White	4500K	3800156612648
SKU: 1265	Warm White	2700K	3800156612655

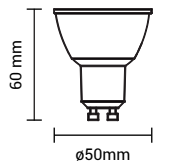
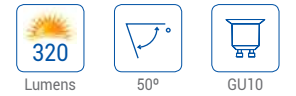

LED Spotlight GU10
6W COB SP6-A4

Watts	6W	CRI	Ra>80
Input Voltage	AC : 220-240V	IP Rating	IP20
Flux	480lm	Dimension	ø50x55 mm
Beam Angle	50°	Body Color	White
Socket	GU10	Dimmable	NO

SKU: 1960	White Light	6000K	3800156619609
SKU: 1961	Neutral White	4500K	3800156619616
SKU: 1962	Warm White	2700K	3800156619623

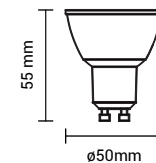

LED Spotlight GU10
4W COB SP4-A3

Watts	4W	CRI	Ra>80
Input Voltage	AC : 220-240V	IP Rating	IP20
Flux	320lm	Dimension	ø50x60 mm
Beam Angle	50°	Body Color	Gray
Socket	GU10	Dimmable	YES

SKU: 1266	White Light	6000K	3800156612662
SKU: 1267	Neutral White	4500K	3800156612679
SKU: 1268	Warm White	2700K	3800156612686

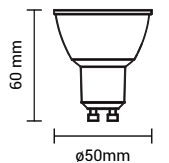

LED Spotlight GU10
6W COB SP6-A5

Watts	6W	CRI	Ra>80
Input Voltage	AC : 220-240V	IP Rating	IP20
Flux	480lm	Dimension	ø50x55 mm
Beam Angle	50°	Body Color	White
Socket	GU10	Dimmable	YES

SKU: 1963	White Light	6000K	3800156619630
SKU: 1964	Neutral White	4500K	3800156619647
SKU: 1965	Warm White	2700K	3800156619654

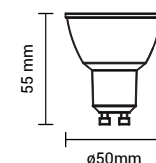

LED Spotlight GU10
6W COB SP6-A5

Watts	6W	CRI	Ra>80
Input Voltage	AC : 220-240V	IP Rating	IP20
Flux	480lm	Dimension	ø50x60 mm
Beam Angle	50°	Body Color	Gray
Socket	GU10	Dimmable	NO

SKU: 1269	White Light	6000K	3800156612693
SKU: 1270	Neutral White	4500K	3800156612709
SKU: 1271	Warm White	2700K	3800156612716

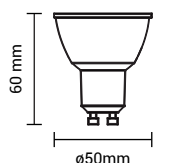
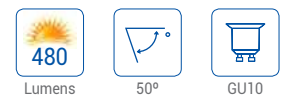

LED Spotlight GU10
6W COB SP6-A5

Watts	6W	CRI	Ra>80
Input Voltage	AC : 220-240V	IP Rating	IP20
Flux	480lm	Dimension	ø50x60 mm
Beam Angle	50°	Body Color	Gray
Socket	GU10	Dimmable	YES

SKU: 1272	White Light	6000K	3800156612723
SKU: 1273	Neutral White	4500K	3800156612730
SKU: 1274	Warm White	2700K	3800156612747

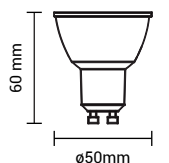



LED Spotlight GU10
5W SMD SP5-A3

Watts	5W	CRI	Ra>80
Input Voltage	AC : 220-240V	IP Rating	IP20
Flux	400lm	Dimension	ø50x57 mm
Beam Angle	110°	Material	Plastic
Socket	GU10	Dimmable	NO

SKU: 1929	White Light	6000K	3800156619296
SKU: 1930	Neutral White	4500K	3800156619302
SKU: 1931	Warm White	2700K	3800156619319

400 Lumens 110° GU10

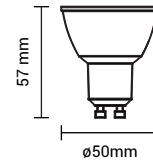

LED Spotlight GU10
5W SMD SP5-A3

Watts	5W	CRI	Ra>80
Input Voltage	AC : 175-265V	IP Rating	IP20
Flux	400lm	Dimension	ø50x57 mm
Beam Angle	38°	Material	Plastic
Socket	GU10	Dimmable	NO

SKU: 1935	White Light	6000K	3800156619357
SKU: 1936	Neutral White	4500K	3800156619364
SKU: 1937	Warm White	2700K	3800156619371

400 Lumens 38° GU10

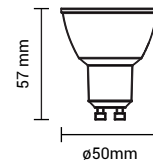

LED Spotlight GU10
7W SMD SP7-A3

Watts	7W	CRI	Ra>80
Input Voltage	AC : 175-265V	IP Rating	IP20
Flux	600lm	Dimension	ø50x57 mm
Beam Angle	110°	Material	Plastic
Socket	GU10	Dimmable	NO

SKU: 1932	White Light	6000K	3800156619326
SKU: 1933	Neutral White	4500K	3800156619333
SKU: 1934	Warm White	2700K	3800156619340

600 Lumens 110° GU10

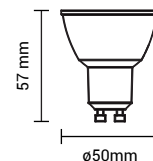

LED Spotlight GU10
7W SMD SP7-A3

Watts	7W	CRI	Ra>80
Input Voltage	AC : 175-265V	IP Rating	IP20
Flux	560lm	Dimension	ø50x57 mm
Beam Angle	38°	Material	Plastic
Socket	GU10	Dimmable	NO

SKU: 1938	White Light	6000K	3800156611689
SKU: 1939	Neutral White	4500K	3800156611696
SKU: 1940	Warm White	2700K	3800156611702

560 Lumens 38° GU10

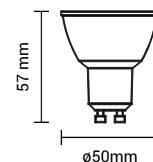

LED Spotlight GU10
7W SMD SP7-A3

Watts	7W	CRI	Ra>80
Input Voltage	AC : 175-265V	IP Rating	IP20
Flux	500lm	Dimension	ø50x57 mm
Beam Angle	110°	Material	Plastic
Socket	GU10	Dimmable	YES

SKU: 1945	White Light	6000K	3800156619456
SKU: 1946	Neutral White	4500K	3800156619463
SKU: 1947	Warm White	2700K	3800156619470

Dimmable 500 Lumens 110° GU10

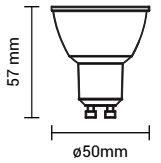

LED Spotlight GU10
7W SMD SP7-A4

Watts	7W	CRI	Ra>80
Input Voltage	AC : 175-265V	IP Rating	IP20
Flux	560lm	Dimension	ø50x57 mm
Beam Angle	38°	Material	Plastic
Socket	GU10	Dimmable	YES

SKU: 1943	Neutral White	4500K	3800156619432
-----------	---------------	-------	---------------

Dimmable 560 Lumens 38° GU10

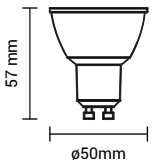

LED Spotlight GU10
10W SMD SP10-A3

Watts	10W	CRI	Ra>80
Input Voltage	AC : 175-265V	IP Rating	IP20
Flux	880lm	Dimension	ø50x57 mm
Beam Angle	110°	Material	Plastic
Socket	GU10	Dimmable	NO

SKU: 1970	White Light	6000K	3800156619708
SKU: 1971	Neutral White	4500K	3800156619715
SKU: 1972	Warm White	2700K	3800156619722

880 Lumens 110° GU10

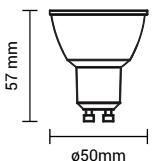



LED Bulbs Premium Line

5 Years
Warranty



LED Bulb A60
10W E27 SP10-A2

950 Lumens 5 Years Warranty E27

Watts	10W	CRI	Ra>80
Input Voltage	AC : 175-265V	IP Rating	IP20
Flux	950lm	Dimension	ø60x109 mm
Beam Angle	270°	Body Type	A60
Socket	E27	Dimmable	NO

SKU: 1718	White Light	6000K	3800156617186
SKU: 1719	Neutral White	4500K	3800156617193
SKU: 1720	Warm White	2700K	3800156617209

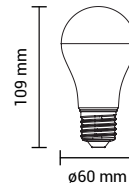

3 PCS
PACK



LED Bulb A60
10W E27 SP10-A2

880 Lumens 5 Years Warranty E27

Watts	10W	CRI	Ra>80
Input Voltage	AC : 175-265V	IP Rating	IP20
Flux	880lm	Dimension	ø60x109 mm
Beam Angle	270°	Body Type	A60
Socket	E27	Dimmable	NO

SKU: 1727	White Light	6000K	3800156617278
SKU: 1728	Neutral White	4500K	3800156617285
SKU: 1729	Warm White	2700K	3800156617292

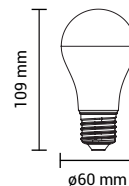

LED Bulb A60
12W E27 SP12-A4

1155 Lumens 5 Years Warranty E27

Watts	12W	CRI	Ra>80
Input Voltage	AC : 175-265V	IP Rating	IP20
Flux	1155lm	Dimension	ø60x112 mm
Beam Angle	270°	Body Type	A60
Socket	E27	Dimmable	NO

SKU: 1721	White Light	6000K	3800156617216
SKU: 1722	Neutral White	4500K	3800156617223
SKU: 1723	Warm White	2700K	3800156617230

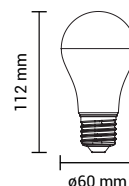

3 PCS
PACK

LED Bulb A60
12W E27 SP12-A4

1155 Lumens 5 Years Warranty E27

Watts	12W	CRI	Ra>80
Input Voltage	AC : 175-265V	IP Rating	IP20
Flux	1155lm	Dimension	ø60x112 mm
Beam Angle	270°	Body Type	A60
Socket	E27	Dimmable	NO

SKU: 1730	White Light	6000K	3800156617308
SKU: 1731	Neutral White	4500K	3800156617315
SKU: 1732	Warm White	2700K	3800156617322

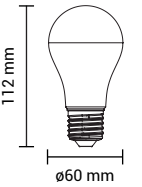

LED Bulb A60
15W E27 SP15-A6

1500 Lumens 5 Years Warranty E27

Watts	15W	CRI	Ra>80
Input Voltage	AC : 175-265V	IP Rating	IP20
Flux	1500lm	Dimension	ø60x127 mm
Beam Angle	270°	Body Type	A60
Socket	E27	Dimmable	NO

SKU: 1724	White Light	6000K	3800156617247
SKU: 1725	Neutral White	4500K	3800156617254
SKU: 1726	Warm White	2700K	3800156617261

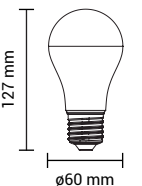

LED Bulb A60
15W E27 SP15-A6

1500 Lumens 5 Years Warranty E27

Watts	15W	CRI	Ra>80
Input Voltage	AC : 175-265V	IP Rating	IP20
Flux	1500lm	Dimension	ø60x127 mm
Beam Angle	270°	Body Type	A60
Socket	E27	Dimmable	NO

SKU: 1733	White Light	6000K	3800156617339
SKU: 1734	Neutral White	4500K	3800156617346
SKU: 1735	Warm White	2700K	3800156617353

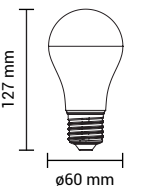

3 PCS
PACK



LED Bulb A70
18W E27 SP18-A1

1880 Lumens 5 Years Warranty E27

Watts	18W	CRI	Ra>80
Input Voltage	AC : 175-265V	IP Rating	IP20
Flux	1880lm	Dimension	ø70x145 mm
Beam Angle	270°	Body Type	A70
Socket	E27	Dimmable	NO

SKU: 1748	White Light	6000K	3800156617483
SKU: 1749	Neutral White	4500K	3800156617490
SKU: 1750	Warm White	2700K	3800156617506

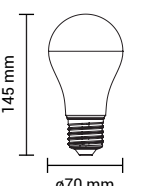



5 Years
Warranty

LED Bulb G45
4W E27 SP4-A5

Watts 4W
Input Voltage AC : 175-265V
Flux 320lm
Beam Angle 180°
Socket E27

CRI Ra>80
IP Rating IP20
Dimension ø45x75 mm
Body Type G45
Dimmable NO

SKU: 1736 White Light 6000K 3800156617360
SKU: 1737 Neutral White 4500K 3800156617377
SKU: 1738 Warm White 2700K 3800156617384

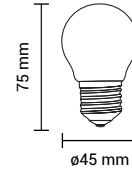

5 Years
Warranty

LED Bulb G45
6W E27 SP6-A8

Watts 6W
Input Voltage AC : 175-265V
Flux 480lm
Beam Angle 180°
Socket E27

CRI Ra>80
IP Rating IP20
Dimension ø45x75 mm
Body Type G45
Dimmable NO

SKU: 1739 White Light 6000K 3800156617391
SKU: 1740 Neutral White 4500K 3800156617407
SKU: 1741 Warm White 2700K 3800156617414

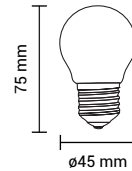
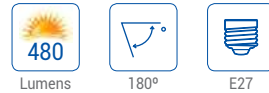

5 Years
Warranty

LED Bulb G95
12W E27 SP12-A4

Watts 12W
Input Voltage AC : 175-265V
Flux 1055lm
Beam Angle 270°
Socket E27

CRI Ra>80
IP Rating IP20
Dimension ø95x127 mm
Body Type G95
Dimmable NO

SKU: 1742 White Light 6000K 3800156617421
SKU: 1743 Neutral White 4500K 3800156617438
SKU: 1744 Warm White 2700K 3800156617445

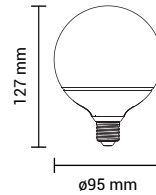

5 Years
Warranty

LED Bulb G120
15W E27 SP15-A6

Watts 15W
Input Voltage AC : 175-265V
Flux 1320lm
Beam Angle 270°
Socket E27

CRI Ra>80
IP Rating IP20
Dimension ø120x155 mm
Body Type G120
Dimmable NO

SKU: 1745 White Light 6000K 3800156617452
SKU: 1746 Neutral White 4500K 3800156617469
SKU: 1747 Warm White 2700K 3800156617476

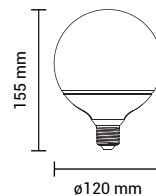

5 Years
Warranty

LED Candle C37
6W E14 SP6-A8

Watts 6W
Input Voltage AC : 175-265V
Flux 480lm
Beam Angle 180°
Socket E14

CRI Ra>80
IP Rating IP20
Dimension ø37x100 mm
Body Type C37
Dimmable NO

SKU: 1780 White Light 6000K 3800156617803
SKU: 1781 Neutral White 4500K 3800156617810
SKU: 1782 Warm White 2700K 3800156617827

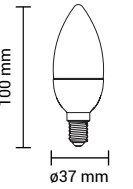
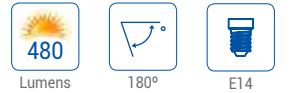

5 Years
Warranty

LED Candle C37 Tip
6W E14 SP6-A8

Watts 6W
Input Voltage AC : 175-265V
Flux 480lm
Beam Angle 180°
Socket E14

CRI Ra>80
IP Rating IP20
Dimension ø37x125 mm
Body Type C37 Tip
Dimmable NO

SKU: 1751 White Light 6000K 3800156617513
SKU: 1752 Neutral White 4500K 3800156617520
SKU: 1759 Warm White 2700K 3800156617599

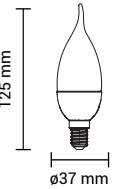
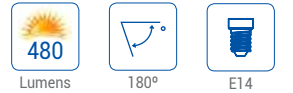

5 Years
Warranty

LED Bulb P45
6W E14 SP6-A8

Watts 6W
Input Voltage AC : 175-265V
Flux 480lm
Beam Angle 240°
Socket E14

CRI Ra>80
IP Rating IP20
Dimension ø45x78 mm
Body Type P45
Dimmable NO

SKU: 1753 White Light 6000K 3800156617537
SKU: 1754 Neutral White 4500K 3800156617544
SKU: 1755 Warm White 2700K 3800156617551

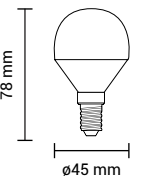

5 Years
Warranty

LED Bulb R50
6W E14 SP6-A8

Watts 6W
Input Voltage AC : 175-265V
Flux 450lm
Beam Angle 200°
Socket E14

CRI Ra>80
IP Rating IP20
Dimension ø50x90 mm
Body Type R50
Dimmable NO

SKU: 1756 White Light 6000K 3800156617568
SKU: 1757 Neutral White 4500K 3800156617575
SKU: 1758 Warm White 2700K 3800156617582

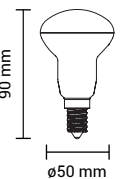



LED Spotlight GU5.3/MR16
5W SMD SP5-A2

Watts	5W	CRI	Ra>80
Input Voltage	DC : 12V	IP Rating	IP20
Flux	320lm	Dimension	ø50x47 mm
Beam Angle	110°	Material	Plastic
Socket	GU5.3	Dimmable	NO

SKU: 1761	White Light	6000K	3800156617612
SKU: 1762	Neutral White	4500K	3800156617629
SKU: 1763	Warm White	2700K	3800156617636

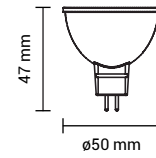
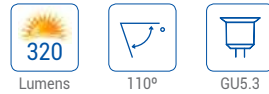

5 Years
Warranty



LED Spotlight GU5.3/MR16
7W SMD SP7-A2

Watts	7W	CRI	Ra>80
Input Voltage	DC : 12V	IP Rating	IP20
Flux	500lm	Dimension	ø50x47 mm
Beam Angle	110°	Material	Plastic
Socket	GU5.3	Dimmable	NO

SKU: 1764	White Light	6000K	3800156617643
SKU: 1765	Neutral White	4500K	3800156617650
SKU: 1766	Warm White	2700K	3800156617667

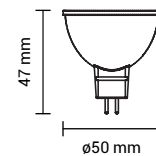

5 Years
Warranty



LED Spotlight GU10
5W SMD SP5-A3

Watts	5W	CRI	Ra>80
Input Voltage	AC : 175-265V	IP Rating	IP20
Flux	320lm	Dimension	ø50x57 mm
Beam Angle	110°	Material	Plastic
Socket	GU10	Dimmable	NO

SKU: 1767	White Light	6000K	3800156617674
SKU: 1768	Neutral White	4500K	3800156617681
SKU: 1769	Warm White	2700K	3800156617698

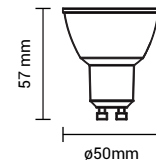

5 Years
Warranty



LED Spotlight GU10
7W SMD SP7-A3

Watts	7W	CRI	Ra>80
Input Voltage	AC : 175-265V	IP Rating	IP20
Flux	600lm	Dimension	ø50x57 mm
Beam Angle	110°	Material	Plastic
Socket	GU10	Dimmable	NO

SKU: 1772	White Light	6000K	3800156617728
SKU: 1770	Neutral White	4500K	3800156617704
SKU: 1773	Warm White	2700K	3800156617735

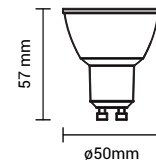
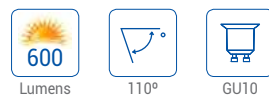

5 Years
Warranty

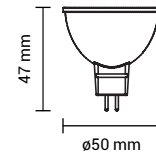

SKU: 5081	WHITE BODY	3800156650817	SKU: 5083	WHITE BODY	3800156650831	SKU: 5085	WHITE BODY	3800156650855
-----------	------------	---------------	-----------	------------	---------------	-----------	------------	---------------

Dimension	180x180x42 mm	Dimension	330x180x42 mm	Dimension	480x180x42 mm
-----------	---------------	-----------	---------------	-----------	---------------

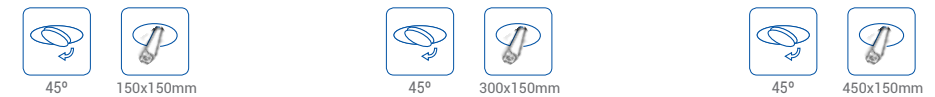

Accessories
AR111 Fitting Adjustable

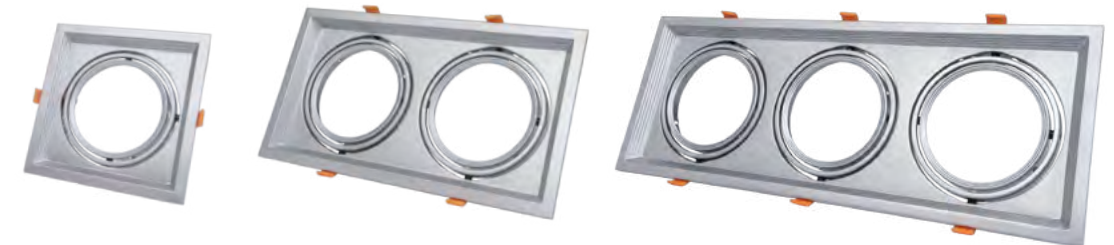

SKU: 5082	SILVER BODY	3800156650824	SKU: 5084	SILVER BODY	3800156650848	SKU: 5086	SILVER BODY	3800156650862
-----------	-------------	---------------	-----------	-------------	---------------	-----------	-------------	---------------

Dimension	180x180x42 mm	Dimension	330x180x42 mm	Dimension	480x180x42 mm
-----------	---------------	-----------	---------------	-----------	---------------

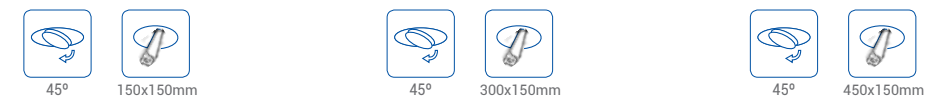

Accessories
AR111 Fitting Adjustable





SKU: 5070 WHITE BODY 3800156650701
Dimension ø82x30 mm

SKU: 5071 INOX BODY 3800156650718
Dimension ø82x30 mm

SKU: 5072 CHROME BODY 3800156650725
Dimension ø82x30 mm

Accessories
GU10,MR16 Fitting



SKU: 5170 WHITE BODY Aluminium
Dimension ø83x29 mm

SKU: 5171 INOX BODY Aluminium
Dimension ø83x29 mm

SKU: 5172 CHROME BODY Aluminium
Dimension ø83x29 mm

SKU: 5097 WHITE BODY 3800156650978
Dimension ø83x29 mm **NEW**

SKU: 5098 INOX BODY 3800156650985
Dimension ø83x29 mm **NEW**

SKU: 5099 CHROME BODY 3800156650992
Dimension ø83x29 mm **NEW**

Accessories
GU10,MR16 Fitting Adjustable



SKU: 5073 WHITE BODY 3800156650732
Dimension 83x83x30 mm

SKU: 5074 INOX BODY 3800156650749
Dimension 83x83x30 mm

SKU: 5075 CHROME BODY 3800156650756
Dimension 83x83x30 mm

Accessories
GU10,MR16 Fitting



SKU: 5076 WHITE BODY 3800156650763
Dimension ø83x29 mm

SKU: 5077 INOX BODY 3800156650770
Dimension ø83x29 mm

SKU: 5078 CHROME BODY 3800156650787
Dimension ø83x29 mm

Accessories
GU10,MR16 Fitting Adjustable





**Spotlight Fixture - Waterproof
GU10 Fitting**



Product code	OT1-A2	IP Rating	IP65
Socket	GU10	Dimension	Φ80x54 ; 83x83x54 mm
Input Voltage	AC : 220-240V	Body Colors	White ; Satin Nickel
Material	Aluminium	Max Power	35W

SKU: 2009 White Body - Round 3800156620094

SKU: 2011 White Body - Square 3800156620117



**Spotlight Fixture - Waterproof
GU10 Fitting**



Product code	OT1-A2	IP Rating	IP65
Socket	GU10	Dimension	Φ80x54 ; 83x83x54 mm
Input Voltage	AC : 220-240V	Body Colors	White ; Satin Nickel
Material	Aluminium	Max Power	35W

SKU: 2010 Satin Nickel - Round 3800156620100

SKU: 2012 Satin Nickel - Square 3800156620124



**Spotlight Fixture - Aluminium
GU10 Fitting**



Product code	OT1-A2	IP Rating	IP20
Socket	GU10	Dimension	φ79x32 mm
Input Voltage	AC : 220-240V	Body Colors	White
Material	Aluminium+PC	Max Power	35W

SKU: 2048 Black Reflector 3800156620483

SKU: 2047 White Reflector 3800156620476

SKU: 2049 Rose Gold Reflector 3800156620490



**Spotlight Fixture - Plastic
GU10 Fitting**



Product code	OT1-A2	IP Rating	IP20
Socket	GU10	Dimension	102x102x42 mm
Input Voltage	AC : 220-240V	Body Colors	White,Black,White-Black
Material	Plastic	Max Power	35W

SKU: 2050 White Body 3800156620506

SKU: 2051 Black Body 3800156620513

SKU: 2052 White-Black Body 3800156620520



**Spotlight Fixture - Aluminium
2xGU10 Fitting Adjustable**



Product code	OT1-A2	IP Rating	IP20
Socket	2xGU10	Dimension	80x160x85
Input Voltage	AC : 220-240V	Body Colors	White-Black
Material	Aluminium	Max Power	35W

SKU: 2080 White- 2xGU10 3800156620803

SKU: 2081 Black- 2XGu10 3800156620810



**Spotlight Fixture - Aluminium
GU10 Fitting Adjustable**



Product code	OT1-A2	IP Rating	IP20
Socket	GU10	Dimension	ø100x38 mm ;100x100x38mm
Input Voltage	AC : 220-240V	Body Colors	White-Black
Material	Aluminium	Max Power	35W

SKU: 2013 White/Black- Round 3800156620131

SKU: 2014 White/Black- Square 3800156620148



**Spotlight Fixture - Aluminium
GU10 Fitting**



Product code	OT1-A2	IP Rating	IP20
Socket	GU10	Dimension	φ120x80mm;120x120x80mm
Input Voltage	AC : 220-240V	Body Colors	Black
Material	Aluminium	Max Power	35W

SKU: 2082 Black-Round 3800156620827

SKU: 2083 Black-Sqyare 3800156620834



**Spotlight Fixture - Aluminium
GU10 Fitting Adjustable**



Product code	OT1-A2	IP Rating	IP20
Socket	GU10	Dimension	185x100x38mm , 270x100x38 mm
Input Voltage	AC : 220-240V	Body Colors	White-Black
Material	Aluminium	Max Power	35W

SKU: 2015 2xGU10 Holder 3800156620155

SKU: 2016 3xGU10 Holder 3800156620162



**Spotlight Fixture - Round
GU10 Fitting**



45°



ø75mm



GU10 Holder



IP20

Product code	OT1-A2	IP Rating	IP20
Socket	GU10	Dimension	φ80x42 mm
Input Voltage	AC : 220-240V	Body Colors	White ; Black
Material	Aluminium+PC	Max Power	35W

SKU: 2031	White	3800156620315
SKU: 2032	Black	3800156620322



**Spotlight Fixture - Round
GU10 Fitting**



45°



ø75mm



GU10 Holder



IP20

Product code	OT1-A2	IP Rating	IP20
Socket	GU10	Dimension	φ80x42 mm
Input Voltage	AC : 220-240V	Body Colors	White ; Black
Material	Aluminium+PC	Max Power	35W

SKU: 2035	Round	3800156620353
SKU: 2036	Black	3800156620360



**Spotlight Fixture - Round
GU10 Fitting**



45°



ø70mm



GU10 Holder



IP20

Product code	OT1-A2	IP Rating	IP20
Socket	GU10	Dimension	φ80x42 mm
Input Voltage	AC : 220-240V	Body Colors	White ; Black
Material	Aluminium+PC	Max Power	35W

SKU: 2033	White	3800156620339
SKU: 2034	Black	3800156620346



**Spotlight Fixture - Round
GU10 Fitting**



45°



ø70mm



GU10 Holder



IP20

Product code	OT1-A2	IP Rating	IP20
Socket	GU10	Dimension	φ80x42 mm
Input Voltage	AC : 220-240V	Body Colors	White ; Black
Material	Aluminium+PC	Max Power	35W

SKU: 2037	White	3800156620377
SKU: 2038	Black	3800156620384



Spotlight Fixture
GU10 Fitting

Product code OT1-A2
 Socket GU10
 Input Voltage AC : 220-240V
 Material Aluminium
 IP Rating IP20
 Dimension 75x75x140 mm
 Body Colors White
 Max Power 35W



SKU: 2039 Black Reflector 3800156620391
 SKU: 2040 White Reflector 3800156620407
 SKU: 2041 Rose Gold Reflector 3800156620414



Spotlight Fixture -Plastic
GU10 Fitting Adjustable

Product code OT1-A2
 Socket GU10
 Input Voltage AC : 220-240V
 Material Plastic
 IP Rating IP20
 Dimension $\Phi 80 \times 125$ mm
 Body Colors White ; Black
 Max Power 10W



SKU: 2001 White Body 3800156620018
 SKU: 2002 Black Body 3800156620025
 SKU: 2005 White Body 3800156620056
 SKU: 2006 Black Body 3800156620063



Spotlight Fixture
GU10 Fitting

Product code OT1-A2
 Socket GU10
 Input Voltage AC : 220-240V
 Material Aluminium
 IP Rating IP20
 Dimension $\Phi 80 \times 140$ mm
 Body Colors White
 Max Power 35W



SKU: 2042 Black Reflector 3800156620421
 SKU: 2043 White Reflector 3800156620438
 SKU: 2044 Rose Gold Reflector 3800156620445



Spotlight Fixture -Plastic
GU10 Fitting Adjustable

Product code OT1-A2
 Socket GU10
 Input Voltage AC : 220-240V
 Material Plastic
 IP Rating IP20
 Dimension 85x85x130 mm
 Body Colors White ; Black
 Max Power 10W



SKU: 2003 White Body 3800156620032
 SKU: 2004 Black Body 3800156620049
 SKU: 2007 White Body 3800156620070
 SKU: 2008 Black Body 3800156620087



Spotlight Fixture - Aluminium
GU10 Fitting Adjustable



Product code	OT1-A2	IP Rating	IP20
Socket	GU10	Dimension	φ80x42 mm
Input Voltage	AC : 220-240V	Body Colors	White ; Black
Material	Aluminium+PC	Max Power	35W

SKU: 2027	White Body	3800156620278
SKU: 2028	Black Body	3800156620285



Tracklight Fixture -Aluminium
GU10 Fitting Adjustable
For 3-Phase Track



Product code	OT1-A2	IP Rating	IP20
Socket	GU10	Dimension	φ55x82 mm
Input Voltage	AC : 220-240V	Body Colors	White ; Black
Material	Aluminium	Max Power	35W

SKU: 2017	White Body	3800156620179
SKU: 2018	Black Body	3800156620186



Spotlight Fixture - Aluminium
GU10 Fitting



Product code	OT1-A2	IP Rating	IP20
Socket	GU10	Dimension	φ60x100 mm
Input Voltage	AC : 220-240V	Body Colors	White ; Black
Material	Aluminium+PC	Max Power	35W

SKU: 2029	White Body	3800156620292
SKU: 2030	Black Body	3800156620308



Tracklight Fixture -Plastic
GU10 Fitting Adjustable
For Single-Phase Track



Product code	OT1-A2	IP Rating	IP20
Socket	GU10	Dimension	φ59x94x114 mm
Input Voltage	AC : 220-240V	Body Colors	White ; Black
Material	Plastic	Max Power	10W

SKU: 2019	White Body	3800156620193
SKU: 2020	Black Body	3800156620209



**Spotlight Fixture - Plastic
GU10 Fitting**



Product code	OT1-A2	IP Rating	IP20
Socket	GU10	Dimension	φ120x145 mm
Input Voltage	AC : 220-240V	Body Colors	White ; Black
Material	Plastic	Max Power	10W

SKU: 2021	White	3800156620216
SKU: 2022	Black	3800156620223

**Spotlight Fixture - Plastic
GU10 Fitting**



Product code	OT1-A2	IP Rating	IP20
Socket	GU10	Dimension	φ120x145 mm
Input Voltage	AC : 220-240V	Body Colors	White ; Black
Material	Plastic	Max Power	10W Each

SKU: 2025	White	3800156620254
SKU: 2026	Black	3800156620261



**Spotlight Fixture - Plastic
GU10 Fitting**



Product code	OT1-A2	IP Rating	IP20
Socket	GU10	Dimension	φ120x145 mm
Input Voltage	AC : 220-240V	Body Colors	White ; Black
Material	Plastic	Max Power	10W Each

SKU: 2023	Round	3800156620230
SKU: 2024	Square	3800156620247

**Spotlight Fixture - Recessed
GU10 Fitting**



Product code	OT1-A2	IP Rating	IP20
Socket	GU10	Dimension	75x75x55mm ; φ85x50mm
Input Voltage	AC : 220-240V	Body Colors	White - Black Reflektor
Material	Aluminium+PC	Max Power	35W

SKU: 2045	Square	3800156620452
SKU: 2046	Round	3800156620469



ø95mm



95x95mm

Ceiling Fixture Trimless Recessed

GU10 Fitting
Gypsum + ALU



Product code	OT1-A2	IP Rating	IP20
Socket	GU10	Dimension	φ100x27mm ; 100x100x27mm
Input Voltage	AC : 220-240V	Body Colors	White
Material	Gypsum+Alu	Max Power	35W

SKU: 2060	Round	3800156620605
SKU: 2061	Square	3800156620612



115x115mm



210x110mm

Ceiling Fixture Trimless Recessed

GU10 Fitting
Gypsum + ALU



Product code	OT1-A2	IP Rating	IP20
Socket	GU10	Dimension	120x120x60mm ; 215x118x58mm
Input Voltage	AC : 220-240V	Body Colors	White
Material	Gypsum+Alu	Max Power	35W

SKU: 2064	Square	3800156620643
SKU: 2065	Rectangle	3800156620650



ø125mm



125x125mm

Ceiling Fixture Trimless Recessed

GU10 Fitting
Gypsum + ALU



Product code	OT1-A2	IP Rating	IP20
Socket	GU10	Dimension	φ130x50mm ; 120x120x60mm
Input Voltage	AC : 220-240V	Body Colors	White
Material	Gypsum+Alu	Max Power	35W

SKU: 2062	Round	3800156620629
SKU: 2063	Square	3800156620636



115x115mm



210x110mm

Ceiling Fixture Trimless Recessed

GU10 Fitting
Gypsum + ALU



Product code	OT1-A2	IP Rating	IP20
Socket	GU10	Dimension	120x120x60mm ; 215x118x58mm
Input Voltage	AC : 220-240V	Body Colors	White
Material	Gypsum+Alu	Max Power	35W

SKU: 2066	Round	3800156620667
SKU: 2067	Square	3800156620674



Ceiling Fixture Trimless Recessed
GU10 Fitting
Gypsum + ALU

Product code	OT1-A2	IP Rating	IP20
Socket	GU10	Dimension	φ120x65mm
Input Voltage	AC : 220-240V	Body Colors	White
Material	Gypsum+Alu	Max Power	35W



SKU: 2068	Round-Frosted	3800156620681
SKU: 2069	Round	3800156620698



Ceiling Fixture Surface Mounted
GU10 Fitting
Gypsum + ALU

Product code	OT1-A2	IP Rating	IP20
Socket	GU10	Dimension	70x70x70mm ; 70x70x170mm
Input Voltage	AC : 220-240V	Body Colors	White
Material	Gypsum+Alu	Max Power	35W



SKU: 2072	Square H70	3800156620728
SKU: 2073	Square H170	3800156620735



Ceiling Fixture Surface Mounted
GU10 Fitting
Gypsum + ALU

Product code	OT1-A2	IP Rating	IP20
Socket	GU10	Dimension	φ70x70 mm ; φ70x170 mm
Input Voltage	AC : 220-240V	Body Colors	White
Material	Gypsum+Alu	Max Power	35W



SKU: 2070	Round H70mm	3800156620704
SKU: 2071	Round H170mm	3800156620711



Ceiling Fixture Surface Mounted
GU10 Fitting
Gypsum + ALU

Product code	OT1-A2	IP Rating	IP20
Socket	GU10	Dimension	φ110x140mm ; 110x110x140mm
Input Voltage	AC : 220-240V	Body Colors	White
Material	Gypsum+Alu	Max Power	35W



SKU: 2074	Round	3800156620742
SKU: 2075	Square	3800156620759



Spotlight Fixture - Single Head GU10 Fitting



Product code	OT1-A6	IP Rating	IP20
Socket	GU10	Dimension	60x108 mm
Input Voltage	AC : 220-240V	Body Colors	Black ; White
Material	Aluminium	Max Power	35W

SKU: 9072	Black	3800156690721
SKU: 9076	White	3800156690769



Spotlight Fixture - Three Heads GU10 Fitting



Product code	OT1-A6	IP Rating	IP20
Socket	GU10x3	Dimension	540x60x180 mm
Input Voltage	AC : 220-240V	Body Colors	Black ; White
Material	Aluminium	Max Power	35W Each

SKU: 9074	Black GU10x3	3800156690745
SKU: 9078	White GU10x3	3800156690783



Spotlight Fixture - Two Heads GU10 Fitting



Product code	OT1-A6	IP Rating	IP20
Socket	GU10x2	Dimension	300x60x180mm
Input Voltage	AC : 220-240V	Body Colors	Black ; White
Material	Aluminium	Max Power	35W Each

SKU: 9073	Black GU10x2	3800156690738
SKU: 9077	White GU10x2	3800156690776



Spotlight Fixture - Four Heads GU10 Fitting



Product code	OT1-A6	IP Rating	IP20
Socket	GU10x4	Dimension	720x60x180 mm
Input Voltage	AC : 220-240V	Body Colors	Black ; White
Material	Aluminium	Max Power	35W Each

SKU: 9075	Black GU10x4	3800156690752
SKU: 9079	White GU10x4	3800156690790



Hanging Fixture - H300mm GU10 Fitting

Product code	OT1-A6	IP Rating	IP20
Socket	GU10	Dimension	60x300 mm
Input Voltage	AC : 220-240V	Body Colors	Black ; White
Material	Aluminium	Max Power	35W



SKU: 9050	Black - Inner range: Gold	3800156690509
SKU: 9051	Black - Inner range: Black	3800156690516
SKU: 9054	White - Inner range: Gold	3800156690547
SKU: 9055	White - Inner range: Black	3800156690554



Hanging Fixture - H500mm GU10 Fitting

Product code	OT1-A6	IP Rating	IP20
Socket	GU10	Dimension	60x500 mm
Input Voltage	AC : 220-240V	Body Colors	Black ; White
Material	Aluminium	Max Power	35W



SKU: 9058	Black Body	3800156690585
SKU: 9059	White Body	3800156690592



Hanging Fixture - H500mm GU10 Fitting

Product code	OT1-A6	IP Rating	IP20
Socket	GU10	Dimension	60x500 mm
Input Voltage	AC : 220-240V	Body Colors	Black ; White
Material	Aluminium	Max Power	35W



SKU: 9052	Black - Inner range: Gold	3800156690523
SKU: 9053	Black - Inner range: Black	3800156690530
SKU: 9056	White - Inner range: Gold	3800156690561
SKU: 9057	White - Inner range: Black	3800156690578



Hanging Fixture - H200mm GU10 Fitting

Product code	OT1-A6	IP Rating	IP20
Socket	GU10	Dimension	60x200 mm
Input Voltage	AC : 220-240V	Body Colors	Black ; White
Material	Aluminium	Max Power	35W



SKU: 9060	Black Body	3800156690608
SKU: 9061	White Body	3800156690615



**Hanging Fixture - H300mm
GU10 Fitting**



Product code	OT1-A6	IP Rating	IP20
Socket	GU10	Dimension	55x300 mm
Input Voltage	AC : 220-240V	Body Colors	B/W/G/CG/C
Material	Aluminium	Max Power	35W

SKU: 9062	Black Body	3800156690622
SKU: 9063	White Body	3800156690639
SKU: 9064	Gold Body	3800156690646
SKU: 9065	Coffee Gold Body	3800156690653
SKU: 9066	Chrome Body	3800156690660

**Hanging Fixture - H300mm
GU10 Fitting**



Product code	OT1-A6	IP Rating	IP20
Socket	GU10	Dimension	55x300 mm
Input Voltage	AC : 220-240V	Body Colors	B/W/G/CG/C
Material	Aluminium	Max Power	35W

SKU: 9067	Black Body	3800156690677
SKU: 9068	White Body	3800156690684
SKU: 9069	Gold Body	3800156690691
SKU: 9070	Coffee Gold Body	3800156690707
SKU: 9071	Chrome Body	3800156690714

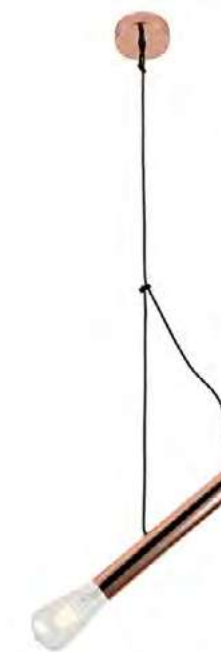

**Hanging Fixture - H400mm
GU10 Fitting**



**Hanging Fixture - H400mm
E27 Fitting**



Product code	OT1-A6	IP Rating	IP20
Socket	GU10	Dimension	60x400 mm
Input Voltage	AC : 220-240V	Body Colors	B/W/S/GR
Material	Aluminium	Max Power	35W

SKU: 9082	Black Body	3800156690820
SKU: 9083	White Body	3800156690837
SKU: 9080	Silver Body	3800156690806
SKU: 9081	Grape Red Body	3800156690813

Product code	OT1-A6	IP Rating	IP20
Socket	E27	Dimension	40x400 mm
Input Voltage	AC : 220-240V	Body Colors	B/W/CG/RG
Material	Aluminium	Max Power	35W

SKU: 9084	Black Body	3800156690844
SKU: 9085	White Body	3800156690851
SKU: 9086	Coffee Gold Body	3800156690868
SKU: 9087	Rose Gold Body	3800156690875

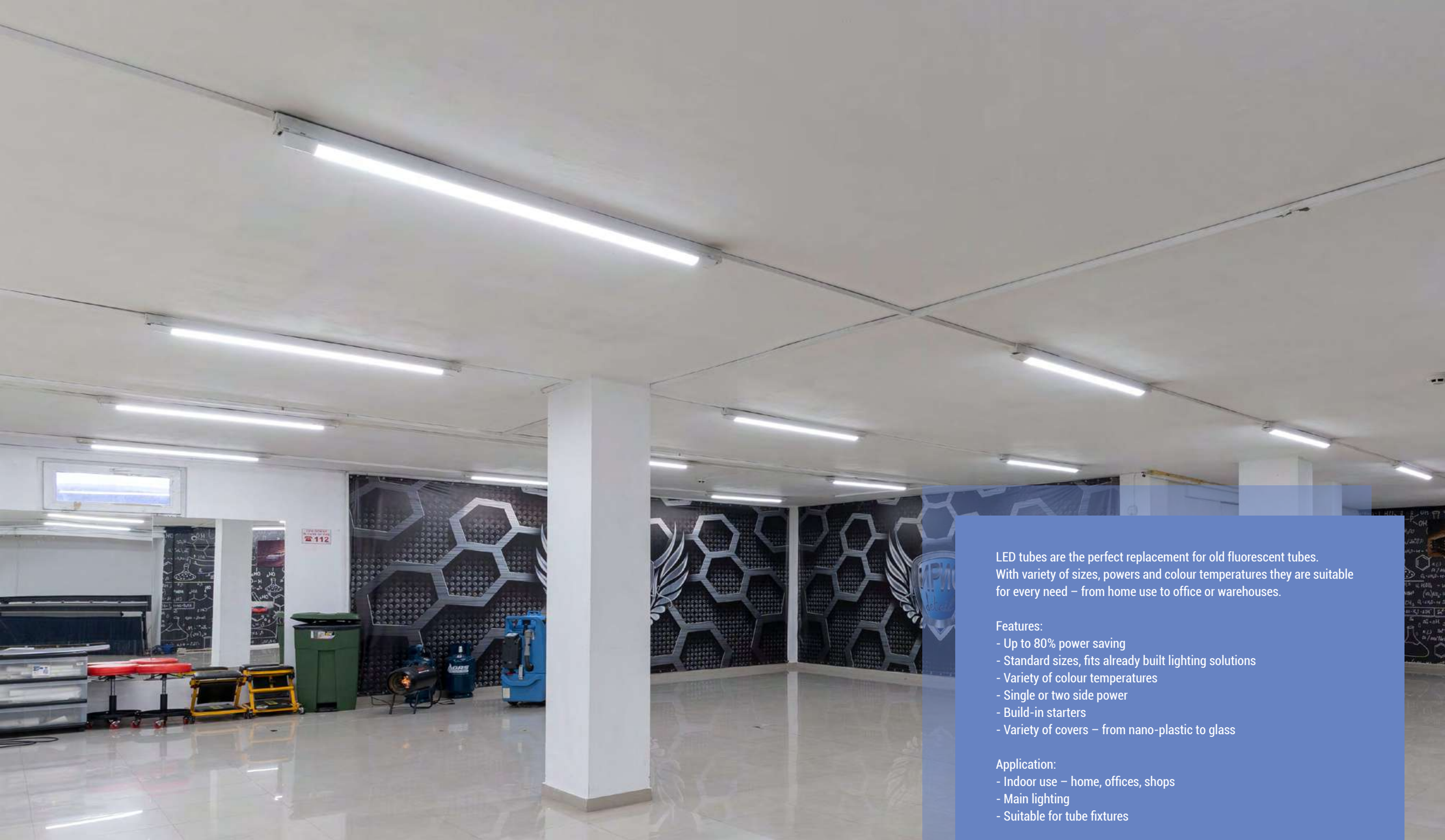

LED tubes are the perfect replacement for old fluorescent tubes. With variety of sizes, powers and colour temperatures they are suitable for every need – from home use to office or warehouses.

Features:

- Up to 80% power saving
- Standard sizes, fits already built lighting solutions
- Variety of colour temperatures
- Single or two side power
- Build-in starters
- Variety of covers – from nano-plastic to glass

Application:

- Indoor use – home, offices, shops
- Main lighting
- Suitable for tube fixtures

LED TUBES AND BATTEN LIGHTS



Switch

**LED TUBE T5 - Plastic
Matt With Switch**



4W	Product code	TU4-A2	Beam Angle	120°
320 Lumens	Watts	4W	CRI	Ra>80
	Input Voltage	AC : 220-240V	IP Rating	IP20
	Flux	320lm	Instant Start	<0.5s

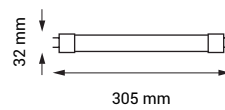

- SKU: 5565 White Light 6000K 3800156655652
- SKU: 5566 Neutral White 4500K 3800156655669
- SKU: 5567 Warm White 2800K 3800156655676

8W	Product code	TU8-A2	Beam Angle	120°
640 Lumens	Watts	8W	CRI	Ra>80
	Input Voltage	AC : 220-240V	IP Rating	IP20
	Flux	640lm	Instant Start	<0.5s

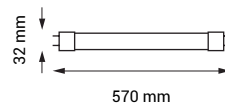

- SKU: 5568 White Light 6000K 3800156655683
- SKU: 5569 Neutral White 4500K 3800156655690
- SKU: 5570 Warm White 2800K 3800156655706

12W	Product code	TU12-A2	Beam Angle	120°
960 Lumens	Watts	12W	CRI	Ra>80
	Input Voltage	AC : 220-240V	IP Rating	IP20
	Flux	960lm	Instant Start	<0.5s

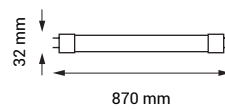

- SKU: 5571 White Light 6000K 3800156655713
- SKU: 5572 Neutral White 4500K 3800156655720
- SKU: 5573 Warm White 2800K 3800156655737

16W	Product code	TU16-A2	Beam Angle	120°
1280 Lumens	Watts	16W	CRI	Ra>80
	Input Voltage	AC : 220-240V	IP Rating	IP20
	Flux	1280lm	Instant Start	<0.5s

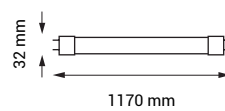

- SKU: 5574 White Light 6000K 3800156655744
- SKU: 5575 Neutral White 4500K 3800156655751
- SKU: 5576 Warm White 2800K 3800156655768

20W	Product code	TU20-A2	Beam Angle	120°
1600 Lumens	Watts	20W	CRI	Ra>80
	Input Voltage	AC : 220-240V	IP Rating	IP20
	Flux	1600lm	Instant Start	<0.5s

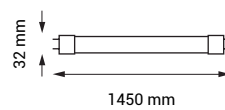

- SKU: 5577 White Light 6000K 3800156655775
- SKU: 5578 Neutral White 4500K 3800156655782
- SKU: 5579 Warm White 2800K 3800156655799



T5 DOUBLE INPUT CABLE

SKU: 6628 / 6629 / 6630
Length: 30cm / 50cm / 100cm

**LED TUBE T5 - Plastic
Matt**



4W	Product code	TU4-A1	Beam Angle	120°
320 Lumens	Watts	4W	CRI	Ra>80
	Input Voltage	AC : 220-240V	IP Rating	IP20
	Flux	320lm	Instant Start	<0.5s

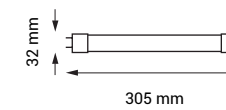

- SKU: 5550 White Light 6000K 3800156655508
- SKU: 5551 Neutral White 4500K 3800156655515
- SKU: 5552 Warm White 2800K 3800156655522

8W	Product code	TU8-A1	Beam Angle	120°
640 Lumens	Watts	8W	CRI	Ra>80
	Input Voltage	AC : 220-240V	IP Rating	IP20
	Flux	640lm	Instant Start	<0.5s

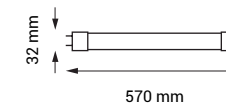

- SKU: 5553 White Light 6000K 3800156655539
- SKU: 5554 Neutral White 4500K 3800156655546
- SKU: 5555 Warm White 2800K 3800156655553

12W	Product code	TU12-A1	Beam Angle	120°
960 Lumens	Watts	12W	CRI	Ra>80
	Input Voltage	AC : 220-240V	IP Rating	IP20
	Flux	960lm	Instant Start	<0.5s

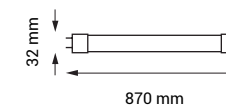

- SKU: 5556 White Light 6000K 3800156655560
- SKU: 5557 Neutral White 4500K 3800156655577
- SKU: 5558 Warm White 2800K 3800156655584

16W	Product code	TU16-A1	Beam Angle	120°
1280 Lumens	Watts	16W	CRI	Ra>80
	Input Voltage	AC : 220-240V	IP Rating	IP20
	Flux	1280lm	Instant Start	<0.5s

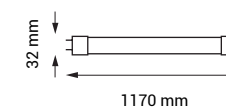

- SKU: 5559 White Light 6000K 3800156655591
- SKU: 5560 Neutral White 4500K 3800156655607
- SKU: 5561 Warm White 2800K 3800156655614

20W	Product code	TU20-A1	Beam Angle	120°
1600 Lumens	Watts	20W	CRI	Ra>80
	Input Voltage	AC : 220-240V	IP Rating	IP20
	Flux	1600lm	Instant Start	<0.5s

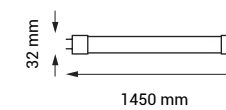

- SKU: 5562 White Light 6000K 3800156655621
- SKU: 5563 Neutral White 4500K 3800156655638
- SKU: 5564 Warm White 2800K 3800156655645



With Starter



Rotatable

LED TUBE T8 PF>0.9

High Lumen

Nano Plastic - One Side Power



7W	Product code	TU7-A3	Beam Angle	270°
1140 Lumens	Watts	7W	CRI	Ra>80
	Input Voltage	AC : 175-250V	IP Rating	IP20
	Flux	1140lm	Instant Start	<0.5s

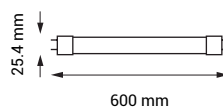

SKU: 5541	White Light	6000K	3800156655416
SKU: 5542	Neutral White	4100K	3800156655423
SKU: 5543	Warm White	2800K	3800156655430

12W	Product code	TU12-A3	Beam Angle	270°
1920 Lumens	Watts	12W	CRI	Ra>80
	Input Voltage	AC : 175-250V	IP Rating	IP20
	Flux	1920lm	Instant Start	<0.5s

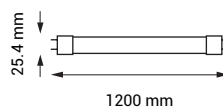

SKU: 5544	White Light	6000K	3800156655447
SKU: 5545	Neutral White	4100K	3800156655454
SKU: 5546	Warm White	2800K	3800156655461

16W	Product code	TU16-A3	Beam Angle	270°
2560 Lumens	Watts	16W	CRI	Ra>80
	Input Voltage	AC : 175-250V	IP Rating	IP20
	Flux	2560lm	Instant Start	<0.5s

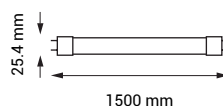

SKU: 5547	White Light	6000K	3800156655478
SKU: 5548	Neutral White	4100K	3800156655485
SKU: 5549	Warm White	2800K	3800156655492



With Starter



Rotatable

LED TUBE T8 PF>0.9

Nano Plastic - One Side Power



9W	Product code	TU9-A3	Beam Angle	270°
900 Lumens	Watts	9W	CRI	Ra>80
	Input Voltage	AC : 175-250V	IP Rating	IP20
	Flux	900lm	Instant Start	<0.5s

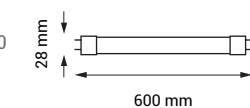

SKU: 5511	White Light	6000K	3800156655119
SKU: 5512	Neutral White	4100K	3800156655126
SKU: 5513	Warm White	2800K	3800156655133

18W	Product code	TU18-A3	Beam Angle	270°
1800 Lumens	Watts	18W	CRI	Ra>80
	Input Voltage	AC : 175-240V	IP Rating	IP20
	Flux	1800lm	Instant Start	<0.5s

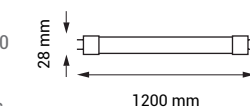

SKU: 5514	White Light	6000K	3800156655140
SKU: 5515	Neutral White	4100K	3800156655157
SKU: 5516	Warm White	2800K	3800156655164

22W	Product code	TU22-A3	Beam Angle	270°
2400 Lumens	Watts	22W	CRI	Ra>80
	Input Voltage	AC : 175-250V	IP Rating	IP20
	Flux	2400lm	Instant Start	<0.5s

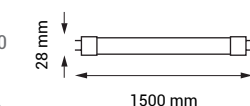

SKU: 5517	White Light	6000K	3800156655171
SKU: 5518	Neutral White	4100K	3800156655188
SKU: 5519	Warm White	2800K	3800156655195



LED TUBE T8 PF>0.9
PRO - Line
Glass - One Side Power



9W	Product code	TU9-A4	Beam Angle	270°
	Watts	9W	CRI	Ra>80
Lumens	Input Voltage	AC : 175-265V	IP Rating	IP20
	Flux	1000lm	Instant Start	<0.5s

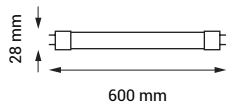

- SKU: 5614 White Light ■ 6000K 3800156656147
- SKU: 5615 Neutral White ■ 4500K 3800156656154

18W	Product code	TU18-A4	Beam Angle	270°
	Watts	18W	CRI	Ra>80
Lumens	Input Voltage	AC : 175-265V	IP Rating	IP20
	Flux	2100lm	Instant Start	<0.5s

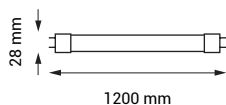

- SKU: 5617 White Light ■ 6000K 3800156656178
- SKU: 5618 Neutral White ■ 4500K 3800156656185

24W	Product code	TU24-A1	Beam Angle	270°
	Watts	24W	CRI	Ra>80
Lumens	Input Voltage	AC : 175-265V	IP Rating	IP20
	Flux	3000lm	Instant Start	<0.5s

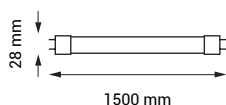

- SKU: 5610 White Light ■ 6000K 3800156656109
- SKU: 5611 Neutral White ■ 4500K 3800156656116



LED TUBE T8 PF>0.9
City Line
Glass - One Side Power



9W	Product code	TU9-A2	Beam Angle	270°
	Watts	9W	CRI	Ra>80
Lumens	Input Voltage	AC : 175-265V	IP Rating	IP20
	Flux	800lm	Instant Start	<0.5s

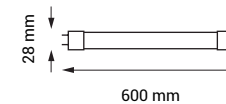

- SKU: 5601 White Light ■ 6000K 3800156656017
- SKU: 5602 Neutral White ■ 4500K 3800156656024
- SKU: 5603 Warm White ■ 3000K 3800156656031

18W	Product code	TU18-A2	Beam Angle	270°
	Watts	18W	CRI	Ra>80
Lumens	Input Voltage	AC : 175-265V	IP Rating	IP20
	Flux	1600lm	Instant Start	<0.5s

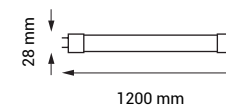

- SKU: 5604 White Light ■ 6000K 3800156656048
- SKU: 5605 Neutral White ■ 4500K 3800156656055
- SKU: 5606 Warm White ■ 3000K 3800156656062

22W	Product code	TU22-A2	Beam Angle	270°
	Watts	22W	CRI	Ra>80
Lumens	Input Voltage	AC : 175-265V	IP Rating	IP20
	Flux	2560lm	Instant Start	<0.5s

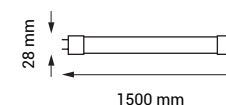

- SKU: 5607 White Light ■ 6000K 3800156656079
- SKU: 5608 Neutral White ■ 4500K 3800156656086
- SKU: 5609 Warm White ■ 3000K 3800156656093



With Starter



140°



IP20

LED TUBE T8 PF>0.9
Professional edition
Aluminium-One Side Power

9W 810 Lumens	Product code	TU9-A1	Beam Angle	140°
	Watts	9W	CRI	Ra>80
	Input Voltage	AC : 175-265V	IP Rating	IP20
	Flux	810lm	Instant Start	<0.5s

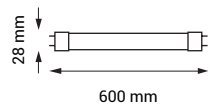

SKU: 5611-M	White Light	6000K	3800156656116
SKU: 5613-M	Neutral White	4500K	3800156656130
SKU: 5612-M	Warm White	2800K	3800156656123

18W 1440 Lumens	Product code	TU18-A1	Beam Angle	140°
	Watts	18W	CRI	Ra>80
	Input Voltage	AC : 175-265V	IP Rating	IP20
	Flux	1440lm	Instant Start	<0.5s

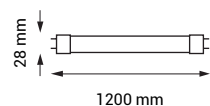

SKU: 5623-M	White Light	6000K	3800156656239
SKU: 5624-M	Warm White	2800K	3800156656246

22W 1700 Lumens	Product code	TU22-A1	Beam Angle	140°
	Watts	22W	CRI	Ra>80
	Input Voltage	AC : 175-265V	IP Rating	IP20
	Flux	1700lm	Instant Start	<0.5s

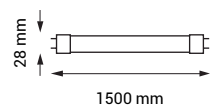

SKU: 5643-M	Warm White	2800K	3800156656437
-------------	------------	-------	---------------



LED TUBE T8
Home edition
Glass - One Side Power



270°



IP20

9W 720 Lumens	Product code	TU9-A2	Beam Angle	270°
	Watts	9W	CRI	Ra>80
	Input Voltage	AC : 175-265V	IP Rating	IP20
	Flux	720lm	Instant Start	<0.5s

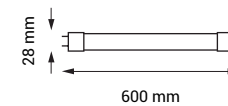

SKU: 5626	White Light	6000K	3800156656260
SKU: 5627	Neutral White	4000K	3800156656277

18W 1440 Lumens	Product code	TU18-A2	Beam Angle	270°
	Watts	18W	CRI	Ra>80
	Input Voltage	AC : 175-265V	IP Rating	IP20
	Flux	1440lm	Instant Start	<0.5s

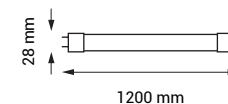

SKU: 5629	White Light	6000K	3800156656291
SKU: 5630	Neutral White	4000K	3800156656307





M12 cable gland



LED FIXTURES WITH T8 TUBES
Single City Line - Glass PF>0.9
One Side Power



180°



IP65

9W



800 Lumens

Product code	OT1-A9	Beam Angle	180°
Watts	9W	CRI	Ra>80
Input Voltage	AC : 220-240V	IP Rating	IP65
Flux	800lm	Instant Start	<0.5s

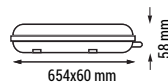

SKU: 6731 White Light 6000K 3800156667310
 SKU: 6732 Neutral White 4500K 3800156667327

18W



1600 Lumens

Product code	OT1-A9	Beam Angle	180°
Watts	18W	CRI	Ra>80
Input Voltage	AC : 220-240V	IP Rating	IP65
Flux	1600lm	Instant Start	<0.5s

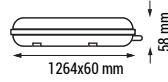

SKU: 6735 White Light 6000K 3800156667358
 SKU: 6736 Neutral White 4500K 3800156667365

22W



2000 Lumens

Product code	OT1-A9	Beam Angle	180°
Watts	22W	CRI	Ra>80
Input Voltage	AC : 220-240V	IP Rating	IP65
Flux	2000lm	Instant Start	<0.5s

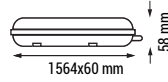

SKU: 6739 White Light 6000K 3800156667396
 SKU: 6740 Neutral White 4500K 3800156667402

Single T8 Tube Fixture - Without Tubes
For One Side Power

SKU: 6650 For Single LED Tube 9W-60cm

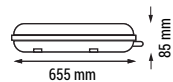

SKU: 6652 For Single LED Tube 18W-120cm

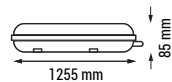

SKU: 6654 For Single LED Tube 22W-150cm

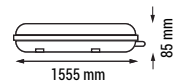

M12 cable gland



LED FIXTURES WITH T8 TUBES
Double City Line - Glass PF>0.9
One Side Power



180°



IP65

2*9W



1600 Lumens

Product code	OT1-B1	Beam Angle	180°
Watts	2*9W	CRI	Ra>80
Input Voltage	AC : 220-240V	IP Rating	IP65
Flux	1600lm	Instant Start	<0.5s

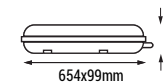

SKU: 6733 White Light 6000K 3800156667334
 SKU: 6734 Neutral White 4500K 3800156667341

2*18W



3200 Lumens

Product code	OT1-B1	Beam Angle	180°
Watts	2*18W	CRI	Ra>80
Input Voltage	AC : 220-240V	IP Rating	IP65
Flux	3200lm	Instant Start	<0.5s

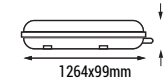

SKU: 6737 White Light 6000K 3800156667372
 SKU: 6738 Neutral White 4500K 3800156667389

2*22W



4000 Lumens

Product code	OT1-B1	Beam Angle	180°
Watts	2*22W	CRI	Ra>80
Input Voltage	AC : 220-240V	IP Rating	IP65
Flux	4000lm	Instant Start	<0.5s

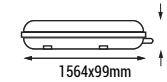

SKU: 6741 White Light 6000K 3800156667419
 SKU: 6742 Neutral White 4500K 3800156667426

Double T8 Tube Fixture - Without Tubes
For One Side Power

SKU: 6651 For Two LED Tube 9W-60cm

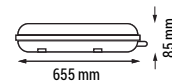

SKU: 6653 For Two LED Tube 18W-120cm

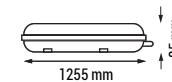

SKU: 6655 For Two LED Tube 22W-150cm

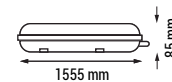



M12 cable gland

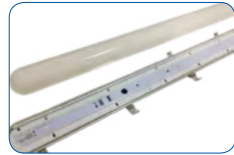

Stainless steel clips

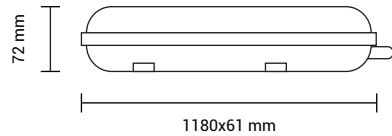

180°



IP65

40W LED
IP65 Fixture Type
Stainless steel clips

40W



Lumens

Product code	OT40-A1	Beam Angle	180°
Watts	40W	CRI	Ra>80
Input Voltage	AC : 220-240V	IP Rating	IP65
Flux	4000lm	Instant Start	<0.5s

SKU: 6701 White Light ■ 6000K 3800156667013
SKU: 6702 Neutral White ■ 4500K 3800156667020



M12 cable gland



Stainless steel clips

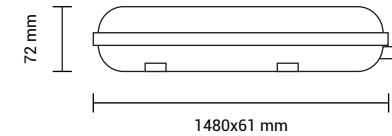

180°



IP65

55W LED
IP65 Fixture Type
Stainless steel clips

55W



Lumens

Product code	OT55-A1	Beam Angle	180°
Watts	55W	CRI	Ra>80
Input Voltage	AC : 220-240V	IP Rating	IP65
Flux	5500lm	Instant Start	<0.5s

SKU: 6703 White Light ■ 6000K 3800156667037
SKU: 6704 Neutral White ■ 4500K 3800156667044

40W



Lumens

Product code	OT40-A1	Beam Angle	180°
Watts	40W	CRI	Ra>80
Input Voltage	AC : 220-240V	IP Rating	IP65
Flux	4000lm	Instant Start	<0.5s



Sensor

SKU: 6705 White Light ■ 6000K 3800156667051
SKU: 6706 Neutral White ■ 4500K 3800156667068

55W



Lumens

Product code	OT55-A1	Beam Angle	180°
Watts	55W	CRI	Ra>80
Input Voltage	AC : 220-240V	IP Rating	IP65
Flux	5500lm	Instant Start	<0.5s



Sensor

SKU: 6707 White Light ■ 6000K 3800156667075
SKU: 6708 Neutral White ■ 4500K 3800156667082

40W



Lumens

Product code	TU40-A1	Beam Angle	180°
Watts	40W	CRI	Ra>80
Input Voltage	AC : 220-240V	IP Rating	IP65
Flux	4000lm	Instant Start	<0.5s



Emergency

SKU: 6709 White Light ■ 6000K 3800156667099
SKU: 6710 Neutral White ■ 4500K 3800156667105

55W



Lumens

Product code	OT55-A1	Beam Angle	180°
Watts	55W	CRI	Ra>80
Input Voltage	AC :220-240V	IP Rating	IP65
Flux	6000lm	Instant Start	<0.5s



Emergency

SKU: 6711 White Light ■ 6000K 3800156667112
SKU: 6712 Neutral White ■ 4500K 3800156667129



Single T8 Fixture for LED One Side Power Tube



Product code	OT1-A7	IP Rating	IP20
Socket	T8	Dimension	606x33mm;1250x33mm
Input Voltage	AC : 220-240V	Body Colors	White
Material	Metal+PC	Max Power	100W

SKU: 6745	1xT8-60cm Tube	3800156667457
SKU: 6746	1xT8-120cm Tube	3800156667464



Double T8 Fixture for LED One Side Power Tube



Product code	OT1-A7	IP Rating	IP20
Socket	2xT8	Dimension	606x73mm;1250x73mm
Input Voltage	AC : 220-240V	Body Colors	White
Material	Metal+PC	Max Power	100W

SKU: 6747	2xT8-60cm Tube	3800156667471
SKU: 6748	2xT8-120cm Tube	3800156667488



LED Batten Light PF>0.9 Stainless steel clips



Product code	OT10-A2	Beam Angle	120°
Watts	10W	CRI	Ra>80
Input Voltage	AC : 220-240V	IP Rating	IP20
Flux	1150lm	Instant Start	<0.5s

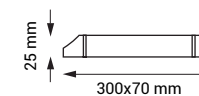

SKU: 6671	White Light	6000K	3800156666719
SKU: 6672	Neutral White	4000K	3800156666726
SKU: 6673	Warm White	3000K	3800156666733



Product code	OT20-A1	Beam Angle	120°
Watts	20W	CRI	Ra>80
Input Voltage	AC : 220-240V	IP Rating	IP20
Flux	2300lm	Instant Start	<0.5s

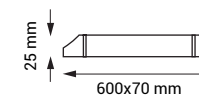

SKU: 6674	White Light	6000K	3800156666740
SKU: 6675	Neutral White	4000K	3800156666757
SKU: 6676	Warm White	3000K	3800156666764



Product code	OT40-A4	Beam Angle	120°
Watts	40W	CRI	Ra>80
Input Voltage	AC : 220-240V	IP Rating	IP20
Flux	3320lm	Instant Start	<0.5s

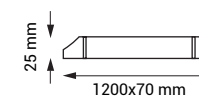

SKU: 6677	White Light	6000K	3800156666771
SKU: 6678	Neutral White	4000K	3800156666788
SKU: 6679	Warm White	3000K	3800156666795



Product code	OT50-A1	Beam Angle	120°
Watts	50W	CRI	Ra>80
Input Voltage	AC : 220-240V	IP Rating	IP20
Flux	4150lm	Instant Start	<0.5s

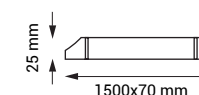

SKU: 6680	White Light	6000K	3800156666801
SKU: 6681	Neutral White	4000K	3800156666818



LED Batten Lights PF>0.9
Waterproof IP65



20W 1600 Lumens	Product code	OT20-A2	Beam Angle	120°
	Watts	20W	CRI	Ra>80
	Input Voltage	AC : 220-240V	IP Rating	IP65
	Flux	1600lm	Instant Start	<0.5s

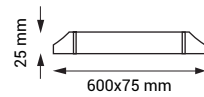

SKU: 6691 White Light ■ 6000K 3800156666917
SKU: 6692 Neutral White ■ 4000K 3800156666924

40W 3200 Lumens	Product code	OT40-A5	Beam Angle	120°
	Watts	40W	CRI	Ra>80
	Input Voltage	AC : 220-240V	IP Rating	IP65
	Flux	3200lm	Instant Start	<0.5s

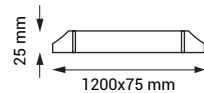

SKU: 6694 White Light ■ 6000K 3800156666948
SKU: 6695 Neutral White ■ 4000K 3800156666955

50W 4150 Lumens	Product code	OT50-A2	Beam Angle	120°
	Watts	50W	CRI	Ra>80
	Input Voltage	AC : 220-240V	IP Rating	IP65
	Flux	4150lm	Instant Start	<0.5s

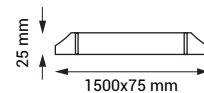

SKU: 6697 White Light ■ 6000K 3800156666979
SKU: 6698 Neutral White ■ 4000K 3800156666986



LED Light Fitting PF>0.9
Stainless steel clips
With fast M12 cable gland



18W 1800 Lumens	Product code	OT18-A1	Beam Angle	180°
	Watts	18W	CRI	Ra>80
	Input Voltage	AC : 220-240V	IP Rating	IP65
	Flux	1800lm	Instant Start	<0.5s

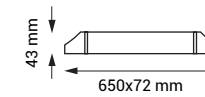

SKU: 6721 White Light ■ 6000K 3800156667211
SKU: 6722 Neutral White ■ 4000K 3800156667228

36W 3600 Lumens	Product code	OT36-A1	Beam Angle	180°
	Watts	36W	CRI	Ra>80
	Input Voltage	AC : 175-250V	IP Rating	IP65
	Flux	3600lm	Instant Start	<0.5s

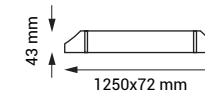

SKU: 6723 White Light ■ 6000K 3800156667235
SKU: 6724 Neutral White ■ 4000K 3800156667242

45W 4500 Lumens	Product code	OT45-A1	Beam Angle	180°
	Watts	45W	CRI	Ra>80
	Input Voltage	AC : 220-240V	IP Rating	IP65
	Flux	4500lm	Instant Start	<0.5s

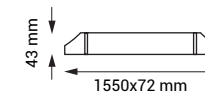

SKU: 6725 White Light ■ 6000K 3800156667259
SKU: 6726 Neutral White ■ 4000K 3800156667266



Industry-wide requirement throughout the entire world now, a prerequisite for all residential and business sites, OPTONICA LED covers all major subcategories.

Features:

- Up to 80% power saving
- Self-test mode with battery state indicator
- Various directions pictograms included
- 3 hours emergency operation
- Highly reliable with instant automatic on.

Application:

- Suitable for residential, industrial and commercial projects

LED EMERGENCY LIGHTS

EMERGENCY LED EXIT SIGN

An emergency light is a battery-backed lighting device that switches on automatically when a building experiences a power outage.

All bulkhead and exit signs include 4 pictograms:



Battery

● Left Arrow



● Right Arrow



● UP Arrow



● EXIT



EMERGENCY LED EXIT SIGN

Wall / Surface Mount



Battery

Product code	WW1-A1
Watts	3W
Input Voltage	AC : 220-240V
IP Rating	IP20
Battery	3.6V 900mAh Ni-Cd battery
Emergency Duration	> 3 Hours

SKU: 7203 White Light 6000K 3800156672031



EMERGENCY LED EXIT SIGN

Wall / Surface Mount



Battery

Product code	WW1-A1
Watts	3W
Input Voltage	AC : 220-240V
IP Rating	IP20
Battery	3.6V 900mAh Ni-Cd battery
Emergency Duration	> 3 Hours

SKU: 7204 White Light 6000K 3800156672048



EMERGENCY LED EXIT SIGN

Recessed Fixed



Battery

Product code	WW1-A1
Watts	3W
Input Voltage	AC : 220-240V
IP Rating	IP20
Battery	3.6V 900mAh Ni-Cd battery
Emergency Duration	> 3 Hours

SKU: 7206 White Light 6000K 3800156672062



EMERGENCY LED EXIT SIGN

Recessed Hanging



Battery

Product code	WW1-A1
Watts	3W
Input Voltage	AC : 220-240V
IP Rating	IP20
Battery	3.6V 900mAh Ni-Cd battery
Emergency Duration	> 3 Hours

SKU: 7205 White Light 6000K 3800156672055





EMERGENCY LED EXIT SIGN

Bulkhead

Product code	WW1-A1
Watts	4W
Input Voltage	AC : 220-240V
IP Rating	IP65
Battery	3.6V 1500mAh Ni-Cd battery
Emergency Duration	> 3 Hours



SKU: 7201 White Light 6000K 3800156672017

SKU: 7202 Recessed kit for SKU: 7201 3800156672024



EMERGENCY LED EXIT SIGN

Wall Mounted

Product code	WW1-A1
Watts	3W
Input Voltage	AC : 220-240V
IP Rating	IP20
Battery	3.6V 1200mAh Ni-Cd battery
Emergency Duration	> 3 Hours



SKU: 7207 White Light 6000K 3800156672079



EMERGENCY LED TWINSPOTS 3W

Wall Mount - Self Test

Product code	WW1-A2
Watts	2x3 pcs 0.5W
Input Voltage	AC : 220-240V
IP Rating	IP20
Battery	3.6V 1800mAh
Emergency Duration	> 3 Hours



SKU: 7208 White Light 6000K 3800156672086



EMERGENCY LED TWINSPOTS 6W

Wall Mount - Self Test

Product code	WW1-A2
Watts	2x6 pcs 0.5W
Input Voltage	AC : 220-240V
IP Rating	IP20
Battery	3.6V 3000mAh
Emergency Duration	> 3 Hours



SKU: 7209 White Light 6000K 3800156672093



EMERGENCY LED LIGHT

Downlight

Product code	WW1-A3
Watts	3W
Input Voltage	AC : 220-240V
IP Rating	IP20
Battery	3.6V 1800mAh
Emergency Duration	> 3 Hours



SKU: 7210 White Light 6000K 3800156672109

OSRAM Chips



EMERGENCY LED LIGHT

Downlight - Osram chip

Product code	WW1-A3
Watts	3W
Input Voltage	AC : 220-240V
IP Rating	IP20
Battery	3.6V 1800mAh
Emergency Duration	> 3 Hours



SKU: 7211 White Light 6000K 3800156672116



Allowing full flexibility of installation on every hard surface so there are no more design restraints.

Features:

- Up to 80% power saving
- Variety of colour temperatures
- Glossy or matt finishing
- Standard sizes
- Variety of powers

Application:

- Extremely wide indoor application use – home, office, retail, hospitals, restaurants, indoor parking lots, manufacturing spaces

LED SURFACE PANELS



3 Years Warranty
 100° Beam Angle
 IP44 Rating



Color Changing knob

CCT - SURFACE LED PANELS
ROUND Build-in Driver

6W
 450 Lumens

Product code	DL6-A3	Beam Angle	100°
Watts	6W	CRI	Ra>80
Input Voltage	AC : 165-265V	IP Rating	IP44 Front
Flux	450lm	Dimension	ø115x32mm

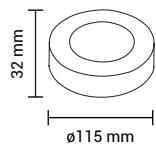

SKU: 2535 3800156625358
 CCT
 6000K 4500K 3000K

12W
 950 Lumens

Product code	DL12-A3	Beam Angle	100°
Watts	12W	CRI	Ra>80
Input Voltage	AC : 165-265V	IP Rating	IP44 Front
Flux	950lm	Dimension	ø170x32mm

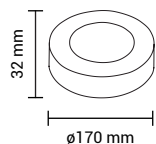

SKU: 2536 3800156625365
 CCT
 6000K 4500K 3000K

18W
 1450 Lumens

Product code	DL18-A3	Beam Angle	100°
Watts	18W	CRI	Ra>80
Input Voltage	AC : 165-265V	IP Rating	IP44 Front
Flux	1450lm	Dimension	ø220x32mm

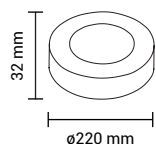

SKU: 2537 3800156625372
 CCT
 6000K 4500K 3000K

24W
 2565 Lumens

Product code	DL24-A3	Beam Angle	100°
Watts	24W	CRI	Ra>80
Input Voltage	AC : 165-265V	IP Rating	IP44 Front
Flux	2565lm	Dimension	ø240x32mm

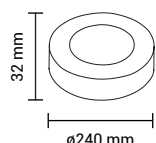

SKU: 2538 3800156625389
 CCT
 6000K 4500K 3000K



3 Years Warranty
 100° Beam Angle
 IP44 Rating



Color Changing Knob

CCT - SURFACE LED PANELS
SQUARE Build-in Driver

6W
 450 Lumens

Product code	DL6-A3	Beam Angle	100°
Watts	6W	CRI	Ra>80
Input Voltage	AC : 165-265V	IP Rating	IP44 Front
Flux	450lm	Dimension	122x122x35mm

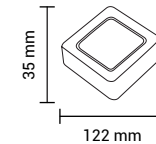

SKU: 2539 3800156625396
 CCT
 6000K 4500K 3000K

12W
 950 Lumens

Product code	DL12-A3	Beam Angle	100°
Watts	12W	CRI	Ra>80
Input Voltage	AC : 165-265V	IP Rating	IP44 Front
Flux	950lm	Dimension	172x172x35mm

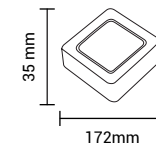

SKU: 2540 3800156625402
 CCT
 6000K 4500K 3000K

18W
 1450 Lumens

Product code	DL18-A3	Beam Angle	100°
Watts	18W	CRI	Ra>80
Input Voltage	AC : 165-265V	IP Rating	IP44 Front
Flux	1450lm	Dimension	227x227x35mm

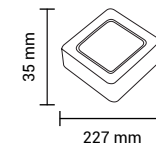

SKU: 2541 3800156625419
 CCT
 6000K 4500K 3000K

24W
 2150 Lumens

Product code	DL24-A3	Beam Angle	100°
Watts	24W	CRI	Ra>80
Input Voltage	AC : 165-265V	IP Rating	IP44 Front
Flux	2150lm	Dimension	227x227x35mm

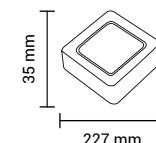

SKU: 2542 3800156625426
 CCT
 6000K 4500K 3000K



LED SURFACE PANELS
ROUND - HOME EDITION



6W
Lumens 480

Product code DL6-B1
Watts 6W
Input Voltage AC : 180-260V
Flux 480lm

Beam Angle 120°
CRI Ra>80
IP Rating IP20
Dimension ø117x28mm

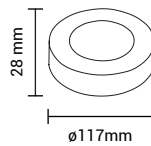

SKU: 2401 White Light 6000K 3800156624016
SKU: 2402 Neutral White 4500K 3800156624023
SKU: 2403 Warm White 2800K 3800156624030

12W
Lumens 960

Product code DL12-B1
Watts 12W
Input Voltage AC : 180-260V
Flux 960lm

Beam Angle 120°
CRI Ra>80
IP Rating IP20
Dimension ø160x28mm

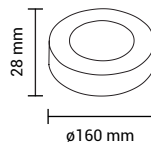

SKU: 2404 White Light 6000K 3800156624047
SKU: 2405 Neutral White 4500K 3800156624054
SKU: 2406 Warm White 2700K 3800156624061

18W
Lumens 1440

Product code DL18-B1
Watts 18W
Input Voltage AC : 180-260V
Flux 1440lm

Beam Angle 120°
CRI Ra>80
IP Rating IP20
Dimension ø205x28mm

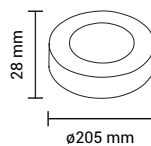

SKU: 2407 White Light 6000K 3800156624078
SKU: 2408 Neutral White 4500K 3800156624085
SKU: 2409 Warm White 2800K 3800156624092

24W
Lumens 1920

Product code DL24-B1
Watts 24W
Input Voltage AC : 180-260V
Flux 1920lm

Beam Angle 120°
CRI Ra>80
IP Rating IP20
Dimension ø285x28mm

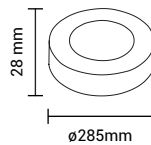

SKU: 2410 White Light 6000K 3800156624108
SKU: 2411 Neutral White 4500K 3800156624115
SKU: 2412 Warm White 2800K 3800156624122



LED SURFACE PANELS
SQUARE - HOME EDITION



6W
Lumens 480

Product code DL6-B1
Watts 6W
Input Voltage AC : 180-260V
Flux 480lm

Beam Angle 120°
CRI Ra>80
IP Rating IP20
Dimension 118x118x28mm

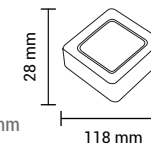

SKU: 2413 White Light 6000K 3800156624139
SKU: 2414 Neutral White 4500K 3800156624146
SKU: 2415 Warm White 2800K 3800156624153

12W
Lumens 960

Product code DL12-B1
Watts 12W
Input Voltage AC : 180-260V
Flux 960lm

Beam Angle 120°
CRI Ra>80
IP Rating IP20
Dimension 160x160x28mm

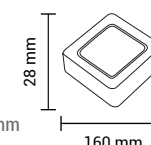

SKU: 2416 White Light 6000K 3800156624160
SKU: 2417 Neutral White 4500K 3800156624177
SKU: 2418 Warm White 2800K 3800156624184

18W
Lumens 1440

Product code DL18-B1
Watts 18W
Input Voltage AC : 180-260V
Flux 1440lm

Beam Angle 120°
CRI Ra>80
IP Rating IP20
Dimension 208x208x28mm

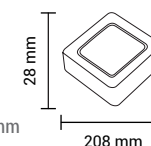

SKU: 2419 White Light 6000K 3800156624191
SKU: 2420 Neutral White 4500K 3800156624207
SKU: 2421 Warm White 2800K 3800156624214

24W
Lumens 1920

Product code DL24-B1
Watts 24W
Input Voltage AC : 180-260V
Flux 1920lm

Beam Angle 120°
CRI Ra>80
IP Rating IP20
Dimension 288x288x28mm

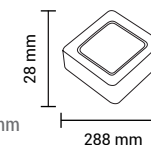

SKU: 2422 White Light 6000K 3800156624221
SKU: 2423 Neutral White 4500K 3800156624238
SKU: 2424 Warm White 2800K 3800156624245



LED SURFACE PANELS
ROUND



Product code DL6-A1
Watts 6W
Input Voltage AC : 85-260V
Flux 480lm
Beam Angle 120°
CRI Ra>80
IP Rating IP20
Dimension ø120x38mm

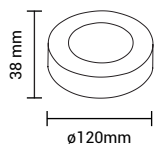

SKU: 2231 White Light 6000K 3800156622319
SKU: 2243 Neutral White 4500K 3800156622432
SKU: 2232 Warm White 2800K 3800156622326



Product code DL12-A1
Watts 12W
Input Voltage AC : 85-260V
Flux 960lm
Beam Angle 120°
CRI Ra>80
IP Rating IP20
Dimension ø172x38mm

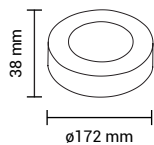

SKU: 2244 White Light 6000K 3800156622449
SKU: 2245 Neutral White 4500K 3800156622456
SKU: 2246 Warm White 2700K 3800156622463



Product code DL18-A1
Watts 18W
Input Voltage AC : 85-260V
Flux 1440lm
Beam Angle 120°
CRI Ra>80
IP Rating IP20
Dimension ø225x38mm

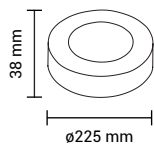

SKU: 2235 White Light 6000K 3800156622357
SKU: 2247 Neutral White 4500K 3800156622470
SKU: 2236 Warm White 2800K 3800156622364



Product code DL24-A1
Watts 24W
Input Voltage AC : 85-260V
Flux 1920lm
Beam Angle 120°
CRI Ra>80
IP Rating IP20
Dimension ø300x38mm

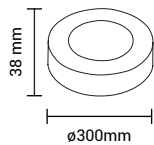

SKU: 2248 White Light 6000K 3800156622487
SKU: 2249 Neutral White 4500K 3800156622494
SKU: 2250 Warm White 2800K 3800156622500



LED SURFACE PANELS
SQUARE



Product code DL6-A1
Watts 6W
Input Voltage AC : 85-260V
Flux 480lm
Beam Angle 120°
CRI Ra>80
IP Rating IP20
Dimension 120x120x38mm

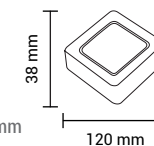

SKU: 2237 White Light 6000K 3800156622371
SKU: 2251 Neutral White 4500K 3800156622517
SKU: 2238 Warm White 2800K 3800156622388



Product code DL12-A1
Watts 12W
Input Voltage AC : 85-260V
Flux 960lm
Beam Angle 120°
CRI Ra>80
IP Rating IP20
Dimension 167x167x38mm

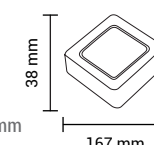

SKU: 2252 White Light 6000K 3800156622524
SKU: 2253 Neutral White 4500K 3800156622531
SKU: 2254 Warm White 2800K 3800156622548



Product code DL18-A1
Watts 18W
Input Voltage AC : 85-260V
Flux 1440lm
Beam Angle 120°
CRI Ra>80
IP Rating IP20
Dimension 220x220x32mm

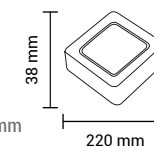

SKU: 2241 White Light 6000K 3800156622418
SKU: 2255 Neutral White 4500K 3800156622555
SKU: 2242 Warm White 2800K 3800156622425



Product code DL24-A1
Watts 24W
Input Voltage AC : 85-260V
Flux 1920lm
Beam Angle 120°
CRI Ra>80
IP Rating IP20
Dimension 295x295x32mm

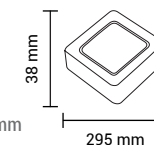

SKU: 2256 White Light 6000K 3800156622562
SKU: 2257 Neutral White 4500K 3800156622579
SKU: 2258 Warm White 2800K 3800156622586

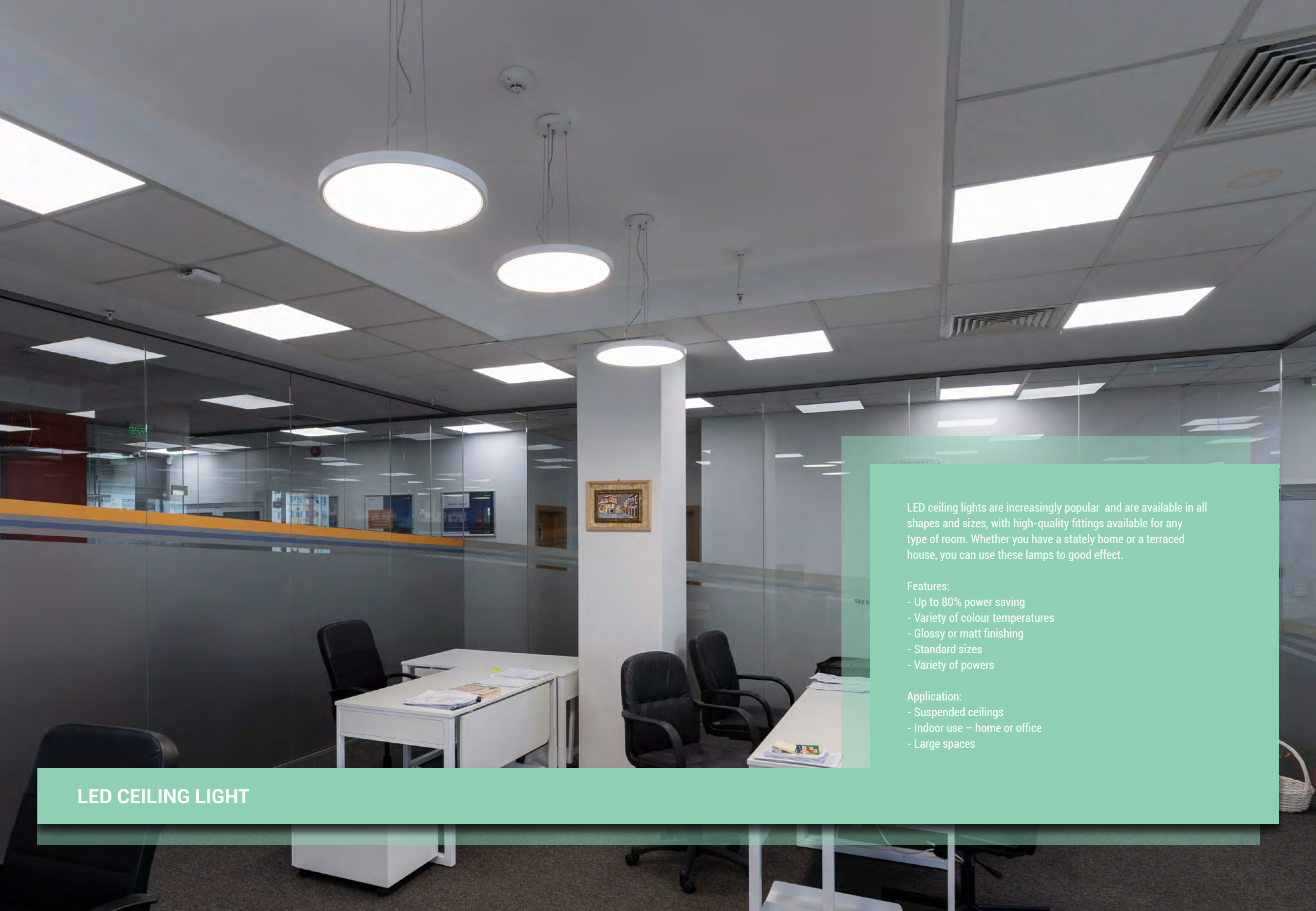

LED ceiling lights are increasingly popular and are available in all shapes and sizes, with high-quality fittings available for any type of room. Whether you have a stately home or a terraced house, you can use these lamps to good effect.

Features:

- Up to 80% power saving
- Variety of colour temperatures
- Glossy or matt finishing
- Standard sizes
- Variety of powers

Application:

- Suspended ceilings
- Indoor use – home or office
- Large spaces

LED CEILING LIGHT



LED CEILING LIGHTS

Black Body - Round

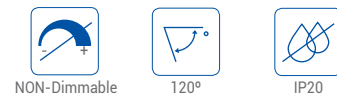

18W 1350 Lumens	Product code	PD18-A2	Beam Angle	120°
	Watts	18W	CRI	Ra>80
	Input Voltage	AC : 175-260V	IP Rating	IP20
	Flux	1350lm	Body Color	Black

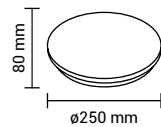

SKU: 2901 Neutral White 4500K 3800156629011
SKU: 2902 Warm White 3000K 3800156629028

30W 2250 Lumens	Product code	PD30-A2	Beam Angle	120°
	Watts	30W	CRI	Ra>80
	Input Voltage	AC : 175-260V	IP Rating	IP20
	Flux	2250lm	Body Color	Black

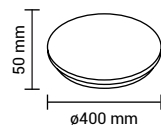

SKU: 2905 Neutral White 4500K 3800156629059
SKU: 2906 Warm White 3000K 3800156629066

54W 4050 Lumens	Product code	PD54-A2	Beam Angle	120°
	Watts	54W	CRI	Ra>80
	Input Voltage	AC : 175-260V	IP Rating	IP20
	Flux	4050lm	Body Color	Black

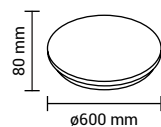

SKU: 2909 Neutral White 4500K 3800156629097
SKU: 2910 Warm White 3000K 3800156629103



LED CEILING LIGHTS

White Body - Round



18W 1350 Lumens	Product code	PD18-A2	Beam Angle	120°
	Watts	18W	CRI	Ra>80
	Input Voltage	AC : 175-260V	IP Rating	IP20
	Flux	1350lm	Body Color	White

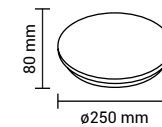

SKU: 2903 Neutral White 4500K 3800156629035
SKU: 2904 Warm White 3000K 3800156629042

30W 2250 Lumens	Product code	PD30-A2	Beam Angle	120°
	Watts	30W	CRI	Ra>80
	Input Voltage	AC : 175-260V	IP Rating	IP20
	Flux	2250lm	Body Color	White

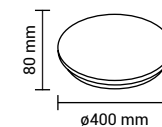

SKU: 2907 Neutral White 4500K 3800156629073
SKU: 2908 Warm White 3000K 3800156629080

54W 4050 Lumens	Product code	PD54-A2	Beam Angle	120°
	Watts	54W	CRI	Ra>80
	Input Voltage	AC : 175-260V	IP Rating	IP20
	Flux	4050lm	Body Color	White

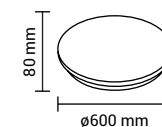

SKU: 2911 Neutral White 4500K 3800156629110
SKU: 2912 Warm White 3000K 3800156629127



LED CEILING LIGHTS
36W - Black

Product code DL36-A2
 Watts 36W CRI Ra>80
 Input Voltage AC : 175-260V IP Rating IP20
 Flux 2700lm Dimension ø500x80 mm
 Beam Angle 120° Body Color Black
 Shape Round Dimmable NO

SKU: 2913 Neutral White 4500K 3800156629134
 SKU: 2914 Warm White 2700K 3800156629141

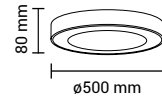
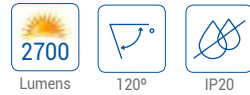

LED CEILING LIGHTS
36W - White

Product code DL36-A2
 Watts 36W CRI Ra>80
 Input Voltage AC : 175-260V IP Rating IP20
 Flux 2700lm Dimension ø500x80 mm
 Beam Angle 120° Body Color White
 Shape Round Dimmable NO

SKU: 2915 Neutral White 4500K 3800156629158
 SKU: 2916 Warm White 2700K 3800156629165

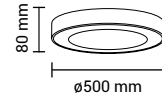

LED CEILING LIGHTS
64W - Black

Product code DL64-A2
 Watts 64W CRI Ra>80
 Input Voltage AC : 175-260V IP Rating IP20
 Flux 4800lm Dimension ø800x80 mm
 Beam Angle 120° Body Color Black
 Shape Round Dimmable NO

SKU: 2917 Neutral White 4500K 3800156629172
 SKU: 2918 Warm White 2700K 3800156629189

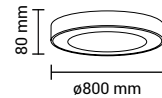
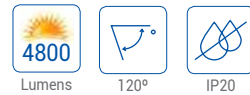

LED CEILING LIGHTS
64W - White

Product code DL64-A2
 Watts 64W CRI Ra>80
 Input Voltage AC : 175-260V IP Rating IP20
 Flux 4800lm Dimension ø800x80 mm
 Beam Angle 120° Body Color White
 Shape Round Dimmable NO

SKU: 2919 Neutral White 4500K 3800156629196
 SKU: 2920 Warm White 2700K 3800156629202

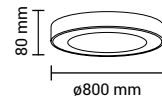

LED CEILING LIGHTS
30W - Black

Product code DL36-A2
 Watts 36W CRI Ra>80
 Input Voltage AC : 175-260V IP Rating IP20
 Flux 2250lm Dimension 380x380 mm
 Beam Angle 120° Body Color Black
 Shape Square Dimmable NO

SKU: 2921 Neutral White 4500K 3800156629134
 SKU: 2922 Warm White 3000K 3800156629141

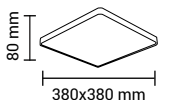

LED CEILING LIGHTS
30W - White

Product code DL36-A2
 Watts 36W CRI Ra>80
 Input Voltage AC : 175-260V IP Rating IP20
 Flux 2250lm Dimension 380x380 mm
 Beam Angle 120° Body Color White
 Shape Square Dimmable NO

SKU: 2923 Neutral White 4500K 3800156629134
 SKU: 2924 Warm White 2700K 3800156629141

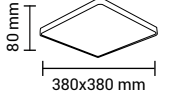
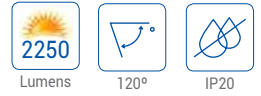

LED CEILING LIGHTS
64W - Black

Product code DL64-A2
 Watts 64W CRI Ra>80
 Input Voltage AC : 175-260V IP Rating IP20
 Flux 4800lm Dimension 600x600 mm
 Beam Angle 120° Body Color Black
 Shape Square Dimmable NO

SKU: 2925 Neutral White 4500K 3800156629134
 SKU: 2926 Warm White 2700K 3800156629141

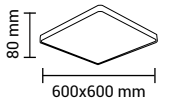

LED CEILING LIGHTS
64W - White

Product code DL64-A2
 Watts 64W CRI Ra>80
 Input Voltage AC : 175-260V IP Rating IP20
 Flux 4800lm Dimension 600x600 mm
 Beam Angle 120° Body Color White
 Shape Square Dimmable NO

SKU: 2927 Neutral White 4500K 3800156629134
 SKU: 2928 Warm White 2700K 3800156629141

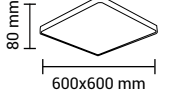

NEW



Remote Control

LED CEILING LIGHTS
Sandy White - Round

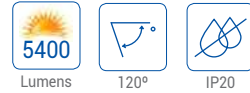

Product code	DL72-A1	CRI	Ra>80
Watts	36x2W	IP Rating	IP20
Input Voltage	AC : 180-260V	Dimension	ø500x50 mm
Flux	5400lm	Body Color	White
Beam Angle	120°	Dimmable	NO
Shape	Round		

SKU: 2931 ← CCT → 3800156629318
■ 6000K ■ 4500K ■ 3000K

NEW



Remote Control

LED CEILING LIGHTS
Sandy White - Round



Product code	DL96-A1	CRI	Ra>80
Watts	48x2W	IP Rating	IP20
Input Voltage	AC : 180-260V	Dimension	ø500x50 mm
Flux	7200lm	Body Color	White
Beam Angle	120°	Dimmable	NO
Shape	Round		

SKU: 2930 ← CCT → 3800156629301
■ 6000K ■ 4500K ■ 3000K

NEW



Remote Control

LED CEILING LIGHTS
Sandy White - Square



Product code	DL120-A1	CRI	Ra>80
Watts	60x2W	IP Rating	IP20
Input Voltage	AC : 180-260V	Dimension	500x500x50 mm
Flux	9000lm	Body Color	White
Beam Angle	120°	Dimmable	NO
Shape	Square		

SKU: 2929 ← CCT → 3800156629295
■ 6000K ■ 4500K ■ 3000K

Ceiling plate for pendant lamps
Does not contain pendant lamps

HANGING ACCESSORIES

Black

SKU: 5181 3800156651814



HANGING ACCESSORIES

White

SKU: 5180 3800156651807





LED SURFACE CEILING
Bulkhead-Thermoplastic

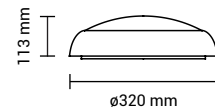
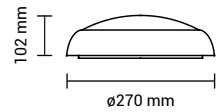

Product code DL8-A3
Watts 8W
Input Voltage AC : 220-240V
Flux 640lm
Beam Angle 120°
CRI Ra>80
IP Rating IP65
Instant Start <0.5s

SKU: 2807 Neutral White 4500K 3800156628076
SKU: 2808 Warm White 2700K 3800156628083



Product code DL13-A1
Watts 13W
Input Voltage AC : 220-240V
Flux 1050lm
Beam Angle 120°
CRI Ra>80
IP Rating IP65
Instant Start <0.5s

SKU: 2813 Neutral White 4500K 3800156628137
SKU: 2814 Warm White 2700K 3800156628144



Product code DL8-A4
Watts 8W
Input Voltage AC : 220-240V
Flux 640lm
Beam Angle 120°
CRI Ra>80
IP Rating IP65
Instant Start <0.5s



SKU: 2809 Neutral White 4500K 3800156628090
SKU: 2810 Warm White 2700K 3800156628106



Product code DL13-A3
Watts 13W
Input Voltage AC : 220-240V
Flux 1050lm
Beam Angle 120°
CRI Ra>80
IP Rating IP65
Instant Start <0.5s



SKU: 2815 Neutral White 4500K 3800156628151
SKU: 2816 Warm White 2700K 3800156628168



Product code DL8-A5
Watts 8W
Input Voltage AC : 220-240V
Flux 640lm
Beam Angle 120°
CRI Ra>80
IP Rating IP65
Instant Start <0.5s



SKU: 2811 Neutral White 4500K 3800156628113
SKU: 2812 Warm White 2700K 3800156628120



Product code DL13-A4
Watts 13W
Input Voltage AC : 220-240V
Flux 1050lm
Beam Angle 120°
CRI Ra>80
IP Rating IP65
Instant Start <0.5s



SKU: 2817 Neutral White 4500K 3800156628175
SKU: 2818 Warm White 2700K 3800156628182

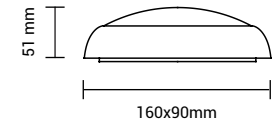

LED SURFACE CEILING 8W
Bulkhead-Thermoplastic

SKU: 2801 White Light 6000K 3800156628014
SKU: 2802 Neutral White 4500K 3800156628021
SKU: 2803 Warm White 2700K 3800156628038

Product code DL8-A2
Watts 8W
Input Voltage AC : 220-240V
Flux 600lm
Beam Angle 120°
Shape Bulkhead
CRI Ra>80
IP Rating IP54
Dimension 160x90x51 mm
Body Color White
Dimmable NO

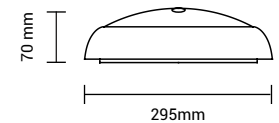
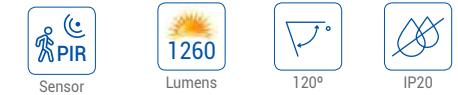

LED SURFACE CEILING 18W
Thermoplastic - PIR

SKU: 2804 White Light 6000K 3800156628045
SKU: 2805 Neutral White 4500K 3800156628052
SKU: 2806 Warm White 2700K 3800156628069

Product code DL18-A9
Watts 18W
Input Voltage AC : 220-240V
Flux 1260lm
Beam Angle 120°
Shape Round
CRI Ra>80
IP Rating IP20
Dimension ø295x70 mm
Body Color White
Dimmable NO



LED CEILING LIGHTS
HOME EDITION - Matt White



12W
880 Lumens

Product code	DL12-B1	Beam Angle	120°
Watts	12W	CRI	Ra>80
Input Voltage	AC : 175-265V	IP Rating	IP20
Flux	880lm	Body Color	White

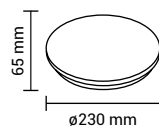

SKU: 2870 White Light 6000K 3800156628700
 SKU: 2871 Neutral White 4500K 3800156628717
 SKU: 2872 Warm White 3000K 3800156628724

LED CEILING LIGHTS
HOME EDITION - Dotty Sparkle



12W
880 Lumens

Product code	DL12-B1	Beam Angle	120°
Watts	12W	CRI	Ra>80
Input Voltage	AC : 175-265V	IP Rating	IP20
Flux	880lm	Body Color	White

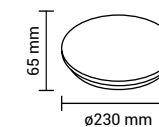

SKU: 2879 White Light 6000K 3800156628793
 SKU: 2880 Neutral White 4500K 3800156628809
 SKU: 2881 Warm White 3000K 3800156628816

18W
1550 Lumens

Product code	DL18-B1	Beam Angle	120°
Watts	18W	CRI	Ra>80
Input Voltage	AC : 175-265V	IP Rating	IP20
Flux	1550lm	Body Color	White

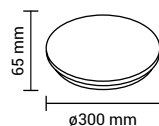

SKU: 2873 White Light 6000K 3800156628731
 SKU: 2874 Neutral White 4500K 3800156628748
 SKU: 2875 Warm White 3000K 3800156628755

18W
1550 Lumens

Product code	DL18-B1	Beam Angle	120°
Watts	18W	CRI	Ra>80
Input Voltage	AC : 175-265V	IP Rating	IP20
Flux	1550lm	Body Color	White

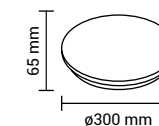

SKU: 2882 White Light 6000K 3800156628823
 SKU: 2883 Neutral White 4500K 3800156628830
 SKU: 2884 Warm White 3000K 3800156628847

24W
1900 Lumens

Product code	DL24-B1	Beam Angle	120°
Watts	24W	CRI	Ra>80
Input Voltage	AC : 175-265V	IP Rating	IP20
Flux	1900lm	Body Color	White

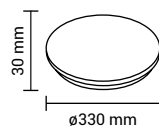

SKU: 2876 White Light 6000K 3800156628762
 SKU: 2877 Neutral White 4500K 3800156628779
 SKU: 2878 Warm White 3000K 3800156628786

24W
1900 Lumens

Product code	DL24-B1	Beam Angle	120°
Watts	24W	CRI	Ra>80
Input Voltage	AC : 175-265V	IP Rating	IP20
Flux	1900lm	Body Color	White

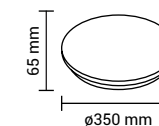

SKU: 2885 White Light 6000K 3800156628854
 SKU: 2886 Neutral White 4500K 3800156628861
 SKU: 2887 Warm White 3000K 3800156628878



LED CEILING LIGHTS

CITY LINE - Matt White



Product code DL12-B1
 Watts 12W
 Input Voltage AC : 175-265V
 Flux 880lm
 Beam Angle 120°
 CRI Ra>80
 IP Rating IP20
 Body Color White

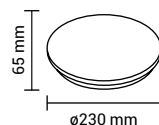

SKU: 2840 White Light 6000K 3800156628403
 SKU: 2841 Neutral White 4500K 3800156628410
 SKU: 2842 Warm White 3000K 3800156628427

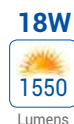

Product code DL18-B1
 Watts 18W
 Input Voltage AC : 175-265V
 Flux 1550lm
 Beam Angle 120°
 CRI Ra>80
 IP Rating IP20
 Body Color White

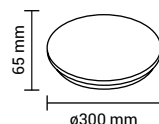

SKU: 2843 White Light 6000K 3800156628434
 SKU: 2844 Neutral White 4500K 3800156628441
 SKU: 2845 Warm White 3000K 3800156628458



Product code DL24-B1
 Watts 24W
 Input Voltage AC : 175-265V
 Flux 1900lm
 Beam Angle 120°
 CRI Ra>80
 IP Rating IP20
 Body Color White

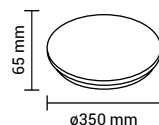

SKU: 2846 White Light 6000K 3800156628465
 SKU: 2847 Neutral White 4500K 3800156628472
 SKU: 2848 Warm White 3000K 3800156628489



LED CEILING LIGHTS

CITY LINE - Dotty Sparkle



Product code DL12-B1
 Watts 12W
 Input Voltage AC : 175-265V
 Flux 840lm
 Beam Angle 120°
 CRI Ra>80
 IP Rating IP20
 Body Color White

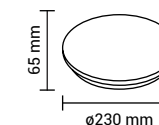

SKU: 2849 White Light 6000K 3800156628496
 SKU: 2850 Neutral White 4500K 3800156628502
 SKU: 2851 Warm White 3000K 3800156628519



Product code DL18-B1
 Watts 18W
 Input Voltage AC : 175-265V
 Flux 1260lm
 Beam Angle 120°
 CRI Ra>80
 IP Rating IP20
 Body Color White

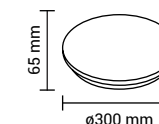

SKU: 2852 White Light 6000K 3800156628526
 SKU: 2853 Neutral White 4500K 3800156628533
 SKU: 2854 Warm White 3000K 3800156628540



Product code DL24-B1
 Watts 24W
 Input Voltage AC : 175-265V
 Flux 1900lm
 Beam Angle 120°
 CRI Ra>80
 IP Rating IP20
 Body Color White

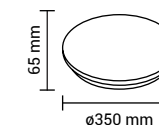

SKU: 2855 White Light 6000K 3800156628557
 SKU: 2856 Neutral White 4500K 3800156628564
 SKU: 2857 Warm White 3000K 3800156628571



Remote Control included



Color changing LED 3000 to 6000K

LED Ceiling Light 36W PF>0.9
Matt White

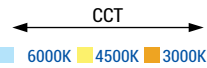

SKU: 2858 3800156628588

Product code	DL36-A4	Remote	No
Watts	36W	CRI	Ra>80
Input Voltage	AC : 185-265V	IP Rating	IP20
Flux	2500lm	Dimension	ø460x70 mm
Beam Angle	120°	Body Color	Matt White
Shape	Round	Dimmable	Yes



Remote Control included



Color changing LED 3000 to 6000K

LED Ceiling Light 36W PF>0.9
Matt White+Dotty Sparkle

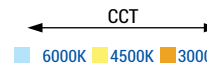

SKU: 2860 3800156628601

Product code	DL36-A5	Remote	Yes
Watts	36W	CRI	Ra>80
Input Voltage	AC : 185-265V	IP Rating	IP20
Flux	2500lm	Dimension	430x430x70 mm
Beam Angle	120°	Body Color	Matt White
Shape	Square	Dimmable	Yes



Remote Control included



Color changing LED 3000 to 6000K

LED Ceiling Light 60W PF>0.9
Matt White

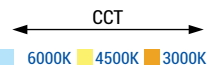

SKU: 2859 3800156628595

Product code	DL60-A4	Remote	No
Watts	60W	CRI	Ra>80
Input Voltage	AC : 185-265V	IP Rating	IP20
Flux	3600lm	Dimension	ø560x70 mm
Beam Angle	120°	Body Color	Matt White
Shape	Round	Dimmable	Yes



Remote Control included



Color changing LED 3000 to 6000K

LED Ceiling Light 60W PF>0.9
Matt White+Dotty Sparkle



SKU: 2861 3800156628618

Product code	DL60-A5	Remote	Yes
Watts	60W	CRI	Ra>80
Input Voltage	AC : 185-265V	IP Rating	IP20
Flux	3600lm	Dimension	530x530x70 mm
Beam Angle	120°	Body Color	Matt White
Shape	Square	Dimmable	Yes



Remote Control included



Dimmable



IP20



Color changing LED 3000 to 6000K

LED Ceiling Light 36W
HOME EDITION - Allstar

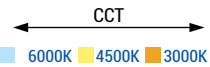

SKU: 2888 3800156628885

Product code	DL36-A6	Remote	Yes
Watts	36W	CRI	Ra>80
Input Voltage	AC : 185-240V	IP Rating	IP20
Flux	2800lm	Dimension	ø380x110 mm
Beam Angle	120°	Body Color	Matt White
Shape	Round	Dimmable	Yes



Remote Control included



Dimmable



IP20



Color changing LED 3000 to 6000K

LED Ceiling Light 60W
HOME EDITION - Allstar

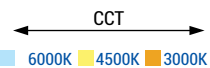

SKU: 2889 3800156628892

Product code	DL60-A6	Remote	Yes
Watts	60W	CRI	Ra>80
Input Voltage	AC : 185-240V	IP Rating	IP20
Flux	4200lm	Dimension	φ485x115 mm
Beam Angle	120°	Body Color	Matt White
Shape	Round	Dimmable	Yes



Warranty



NON-Dimmable



Chips



120°



IP20

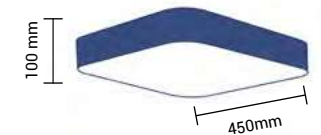

LED Ceiling Light 38W PF>0.95
Sandy White - Square



SKU: 2297 Warm White 3000K 3800156622975

Product code	DL38-A1	CRI	Ra>80
Watts	38W	IP Rating	IP20
Input Voltage	AC : 175-240V	Dimension	450x450x100 mm
Flux	1900lm	Body Color	Sandy White
Beam Angle	120°	Dimmable	NO
Shape	Square		

LED Suspended Lighting
Round Sandy White

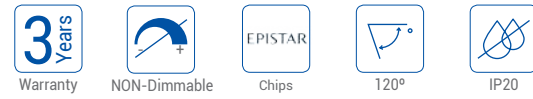

LED Suspended Lighting
38W PF>0.95



SKU: 9036 Warm White 3000K 3800156690363

Product code	PD38-A2	CRI	Ra>80
Watts	38W	IP Rating	IP20
Input Voltage	AC : 175-240V	Dimension	ø450x1200 mm
Flux	2660lm	Body Color	Sandy White
Beam Angle	120°	Dimmable	NO
Shape	Round		

LED Suspended Lighting
Square Sandy White

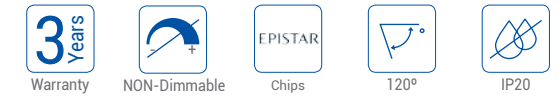

LED Suspended Lighting
38W PF>0.95



SKU: 9038 Warm White 3000K 3800156690387

Product code	PD38-A2	CRI	Ra>80
Watts	38W	IP Rating	IP20
Input Voltage	AC : 175-240V	Dimension	450x450x1200 mm
Flux	2660lm	Body Color	Sandy White
Beam Angle	120°	Dimmable	NO
Shape	Square		

LED Suspended Lighting
50W PF>0.95



SKU: 9037 Warm White 3000K 3800156690370

Product code	PD50-A1	CRI	Ra>80
Watts	50W	IP Rating	IP20
Input Voltage	AC : 175-240V	Dimension	ø600x1200 mm
Flux	3500lm	Body Color	Sandy White
Beam Angle	120°	Dimmable	NO
Shape	Round		

LED Suspended Lighting
50W PF>0.95



SKU: 9039 Warm White 3000K 3800156690394

Product code	PD50-A1	CRI	Ra>80
Watts	50W	IP Rating	IP20
Input Voltage	AC : 175-240V	Dimension	600x600x1200 mm
Flux	3500lm	Body Color	Sandy White
Beam Angle	120°	Dimmable	NO
Shape	Square		



Vintage Rope Pendant
Length 1.5m

SKU: 9027
 Product Code PD1-A2
 E27 holder Max 60W
 IP Rating IP20
 Dimension ø90x1500mm
 EAN: 3800156650596



3D Glass Pendant D250
Copper Circles

SKU: 9002
 Product Code PD1-A1
 E27 holder Max 40W
 Material 3D Glass
 IP Rating IP20
 Dimension ø250x220mm
 EAN: 3800156690028



3D Glass Pendant D250
Chrome Circles

SKU: 9003
 Product Code PD1-A1
 E27 holder Max 40W
 Material 3D Glass
 IP Rating IP20
 Dimension ø250x220mm
 EAN: 3800156690035



3D Glass Pendant D200
Chrome Square

SKU: 9004
 Product Code PD1-A1
 E27 holder Max 40W
 Material 3D Glass
 IP Rating IP20
 Dimension ø200x175mm
 EAN: 3800156690042



3D Glass Pendant D200
Copper Squares

SKU: 9005
 Product Code PD1-A1
 E27 holder Max 40W
 Material 3D Glass
 IP Rating IP20
 Dimension ø200x175mm
 EAN: 3800156690059





**3D Glass Pendant D220
Chrome Circles**

SKU: 9008
 Product Code PD1-A1
 E27 holder Max 40W
 Material 3D Glass
 IP Rating IP20
 Dimension ø220x275mm
 EAN: 3800156690080



E27 Holder



IP20



**3D Glass Pendant D220
Copper Seagull**

SKU: 9009
 Product Code PD1-A1
 E27 holder Max 40W
 Material 3D Glass
 IP Rating IP20
 Dimension ø220x275mm
 EAN: 3800156690097



E27 Holder



IP20



**3D Glass Pendant D220
Chrome Seagull**

SKU: 9011
 Product Code PD1-A1
 E27 holder Max 40W
 Material 3D Glass
 IP Rating IP20
 Dimension ø220x275mm
 EAN: 3800156690110



E27 Holder



IP20



**3D Glass Barel Pendant D200
Copper Fireworks**

SKU: 9013
 Product Code PD1-A1
 E27 holder Max 40W
 Material 3D Glass
 IP Rating IP20
 Dimension ø200x213mm
 EAN: 3800156690134



E27 Holder



IP20



**3D Glass Barel Pendant D200
Chrome Rhombus**

SKU: 9014
 Product Code PD1-A1
 E27 holder Max 40W
 Material 3D Glass
 IP Rating IP20
 Dimension ø200x213mm
 EAN: 3800156690141



E27 Holder



IP20



**3D Glass Barel Pendant D200
Chrome Squares**

SKU: 9015
 Product Code PD1-A1
 E27 holder Max 40W
 Material 3D Glass
 IP Rating IP20
 Dimension ø200x213mm
 EAN: 3800156690158



E27 Holder



IP20



**3D Glass Barel Pendant D200
Chrome Fireworks**

SKU: 9016
 Product Code PD1-A1
 E27 holder Max 40W
 Material 3D Glass
 IP Rating IP20
 Dimension ø200x213mm
 EAN: 3800156690165



E27 Holder



IP20



**3D Glass Umbrella Pendant D400
Copper Seagull**

SKU: 9017
 Product Code PD1-A1
 E27 holder Max 40W
 Material 3D Glass
 IP Rating IP20
 Dimension ø400x200mm
 EAN: 3800156690172



**3D Glass Pendant D200
Chrome Circles**

SKU: 9019
 Product Code PD1-A1
 E27 holder Max 40W
 Material 3D Glass
 IP Rating IP20
 Dimension ø200x165mm
 EAN: 3800156690196



**3D Glass Umbrella Pendant D400
Chrome Circles**

SKU: 9018
 Product Code PD1-A1
 E27 holder Max 40W
 Material 3D Glass
 IP Rating IP20
 Dimension ø400x200mm
 EAN: 3800156690189



**3D Glass Pendant D200
Chrome Seagull**

SKU: 9020
 Product Code PD1-A1
 E27 holder Max 40W
 Material 3D Glass
 IP Rating IP20
 Dimension ø200x165mm
 EAN: 3800156690202



**3D Glass Pendant D200
Copper Circles**

SKU: 9021
 Product Code PD1-A1
 E27 holder Max 40W
 Material 3D Glass
 IP Rating IP20
 Dimension ø200x165mm
 EAN: 3800156690219





**3D Glass Pendant D290
Copper Circles**

SKU: 9022
 Product Code PD1-A1
 E27 holder Max 40W
 Material 3D Glass
 IP Rating IP20
 Dimension ø290x250mm
 EAN: 3800156690226



**3D Glass Pendant D290
Chrome Fireworks**

SKU: 9023
 Product Code PD1-A1
 E27 holder Max 40W
 Material 3D Glass
 IP Rating IP20
 Dimension ø290x250mm
 EAN: 3800156690233



**3D Glass Pendant D400
Chrome Fireworks**

SKU: 9025
 Product Code PD1-A1
 E27 holder Max 40W
 Material 3D Glass
 IP Rating IP20
 Dimension ø400x345mm
 EAN: 3800156690257



**3D Glass Pendant D290
Chrome Seagull**

SKU: 9024
 Product Code PD1-A1
 E27 holder Max 40W
 Material 3D Glass
 IP Rating IP20
 Dimension ø290x250mm
 EAN: 3800156690240



**3D Glass Pendant D400
Copper Fireworks**

SKU: 9026
 Product Code PD1-A1
 E27 holder Max 40W
 Material 3D Glass
 IP Rating IP20
 Dimension ø400x345mm
 EAN: 3800156690264





**LED Flame Bulb
5W SMD E27**



Product code	OT5-A1	CRI	Ra>80
Watts	5W	IP Rating	IP20
Input Voltage	AC : 220-240V	Dimension	ø47x125 mm
Flux	250lm	Socket	E27
Beam Angle	360°		

SKU: 222 Warm White 1300K 3800156602229



**LED Flame Lamp
5W SMD**

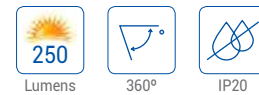

Product code	PD5-A1	CRI	Ra>80
Watts	5W	IP Rating	IP20
Input Voltage	AC : 220-240V	Dimension	ø180xH285 mm
Flux	250lm	E27 holder	LED Flame Bulb Included
Beam Angle	360°		

SKU: 9041 Warm White 1300K 3800156690417



**LED Flame Lamp Wall Mounted
5W SMD**



Product code	PD5-A1	CRI	Ra>80
Watts	5W	IP Rating	IP20
Input Voltage	AC : 220-240V	Dimension	220xH285 mm
Flux	250lm	E27 holder	LED Flame Bulb Included
Beam Angle	360°		

SKU: 9044 Warm White 1300K 3800156690448



**LED Flame Lamp Wall Mounted
5W SMD**



Product code	PD5-A1	CRI	Ra>80
Watts	5W	IP Rating	IP20
Input Voltage	AC : 220-240V	Dimension	180xH260 mm
Flux	250lm	E27 holder	LED Flame Bulb Included
Beam Angle	360°		

SKU: 9045 Warm White 1300K 3800156690455



**LED Flame Lamp With Battery
5W SMD**

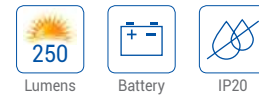

Product code	PD5-A1	CRI	Ra>80
Watts	5W	IP Rating	IP20
Input Voltage	AC : 220-240V	Dimension	ø180xH285 mm
Flux	250lm	E27 holder	LED Flame Bulb Included
Beam Angle	360°		

SKU: 9042 Warm White 1300K 3800156690424



**LED Flame Lamp Hanging
5W SMD**



Product code	PD5-A1	CRI	Ra>80
Watts	5W	IP Rating	IP20
Input Voltage	AC : 220-240V	Dimension	ø150xH330 mm
Flux	250lm	E27 holder	LED Flame Bulb Included
Beam Angle	360°		

SKU: 9043 Warm White 1300K 3800156690431



LED panels offers a broad application in different lighting solutions. With variety of standard sizes they can be placed in suspended ceilings or used as hanging lights.

Features:

- Up to 80% power saving
- Build-in or hanging installations
- Variety of colour temperatures
- Glossy or matt finishing
- Standard sizes
- Variety of powers

Application:

- Suspended ceilings
- Indoor use – home or office
- Large spaces

LED PANELS AND MINI PANELS



LED PANEL PF>0.95
25W With Driver 60x60cm



Product code	DL25-A2	Beam Angle	120°
Watts	25W	CRI	Ra>80
Input Voltage	AC : 175-265V	IP Rating	IP20
Flux	3000lm	BOX Qty	1 PCS



TP(b)RATED
Polycarbonate Diffuser

SKU: 2740	White Light	6000K	3800156627406
SKU: 2741	Neutral White	4500K	3800156627413

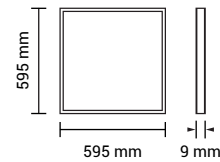

Lumens/W



LED BACKLIT PANEL PF>0.9
25W With Driver 60x60cm



Product code	DL25-A3	Beam Angle	120°
Watts	25W	CRI	Ra>80
Input Voltage	AC : 185-265V	IP Rating	IP20
Flux	4000lm	BOX Qty	10 PCS

SKU: 2770	White Light	6000K	3800156627703
SKU: 2771	Neutral White	4500K	3800156627710

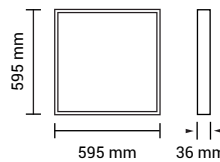

Lumens/W



LED PANEL PF>0.9
29W With Driver 60x60cm



Product code	DL29-A1	Beam Angle	120°
Watts	29W	CRI	Ra>80
Input Voltage	AC : 175-265V	IP Rating	IP20
Flux	3600lm	BOX Qty	6 PCS

SKU: 2382	White Light	6000K	3800156623828
SKU: 2383	Neutral White	4500K	3800156623835
SKU: 2384	Warm White	2700K	3800156623842

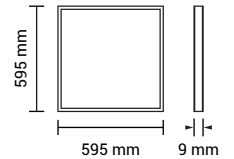

LED BACKLIT PANEL PF>0.9
30W With Driver 60x60cm



Product code	DL30-A3	Beam Angle	120°
Watts	30W	CRI	Ra>80
Input Voltage	AC : 220-240V	IP Rating	IP20
Flux	3600lm	BOX Qty	6 PCS

TP(a)RATED
Polycarbonate Diffuser

SKU: 2776	White Light	6000K	3800156627765
SKU: 2777	Neutral White	4000K	3800156627772

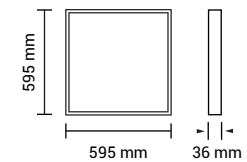

LED PANEL
36W With Driver 60x60cm



Product code	DL36-A1	Beam Angle	120°
Watts	36W	CRI	Ra>80
Input Voltage	AC : 220-240V	IP Rating	IP20
Flux	3200lm	BOX Qty	6 PCS

SKU: 2350	White Light	6000K	3800156623507
SKU: 2363	Neutral White	4500K	3800156623637
SKU: 2351	Warm White	2700K	3800156623514

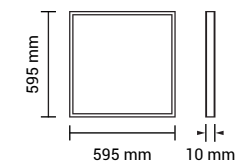

NEW



LED PANEL Single Pack PF>0.9
36W With Driver 62x62cm



Product code	DL36-A4	Beam Angle	120°
Watts	36W	CRI	Ra>80
Input Voltage	AC : 220-240V	IP Rating	IP20
Flux	3600lm	BOX Qty	1 PCS

SKU: 2701	White Light	6000K	3800156627017
SKU: 2702	Neutral White	4500K	3800156627024
SKU: 2703	Warm White	2700K	3800156627031

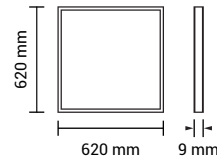

NEW



LED PANEL Single Pack PF>0.9
36W With Driver 62x62cm



Product code	DL36-A4	Beam Angle	120°
Watts	36W	CRI	Ra>80
Input Voltage	AC : 220-240V	IP Rating	IP20
Flux	3600lm	BOX Qty	1 PCS

SKU: 2704	White Light	6000K	3800156627048
SKU: 2705	Neutral White	4500K	3800156627055
SKU: 2706	Warm White	2700K	3800156627062

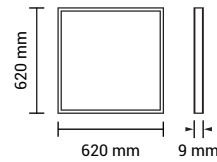

NEW



LED PANEL Single Pack PF>0.9
36W With Driver 62x62cm



Product code	DL36-A4	Beam Angle	120°
Watts	36W	CRI	Ra>80
Input Voltage	AC : 220-240V	IP Rating	IP20
Flux	3600lm	BOX Qty	1 PCS

SKU: 2707	White Light	6000K	3800156627079
SKU: 2708	Neutral White	4500K	3800156627086

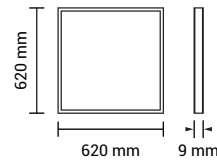

NEW



LED PANEL PF>0.9
36W With Driver 60x60cm



Product code	DL36-A1	Beam Angle	120°
Watts	36W	CRI	Ra>80
Input Voltage	AC : 220-240V	IP Rating	IP20
Flux	3600lm	BOX Qty	6 PCS

SKU: 2711	White Light	6000K	3800156627116
SKU: 2712	Neutral White	4500K	3800156627123
SKU: 2713	Warm White	2700K	3800156627130

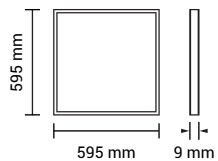

NEW



LED PANEL PF>0.9
36W With Driver 60x60cm



Product code	DL36-A1	Beam Angle	120°
Watts	36W	CRI	Ra>80
Input Voltage	AC : 220-240V	IP Rating	IP20
Flux	3600lm	BOX Qty	6 PCS

SKU: 2717	White Light	6000K	3800156627178
SKU: 2718	Neutral White	4500K	3800156627185

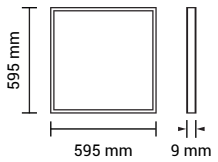

LED PANEL PF>0.95
36W With Driver 60x60cm



Product code	DL36-A2	Beam Angle	120°
Watts	36W	CRI	Ra>80
Input Voltage	AC : 175-265V	IP Rating	IP20
Flux	3500lm	BOX Qty	1 PCS

TP(b)RATED
Polycarbonate Diffuser

SKU: 2744	White Light	6000K	3800156627444
SKU: 2745	Neutral White	4500K	3800156627451

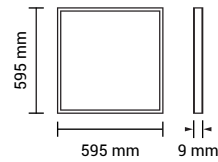

LED PANEL PF>0.9
36W With Driver 62x62cm

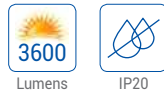

Product code	DL36-A3	Beam Angle	120°
Watts	36W	CRI	Ra>80
Input Voltage	AC : 175-265V	IP Rating	IP20
Flux	3600lm	BOX Qty	1 PCS



SKU: 2734	White Light	6000K	3800156627345
SKU: 2735	Neutral White	4500K	3800156627352
SKU: 2736	Warm White	2700K	3800156627369

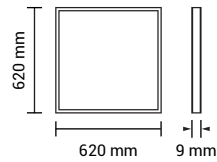

LED BACKLIT PANEL PF>0.9
40W With Driver 60x60cm



Product code	DL40-A3	Beam Angle	120°
Watts	40W	CRI	Ra>80
Input Voltage	AC : 220-240V	IP Rating	IP20
Flux	3400lm	BOX Qty	10 PCS



SKU: 2772	White Light	6000K	3800156627727
SKU: 2773	Neutral White	4000K	3800156627734

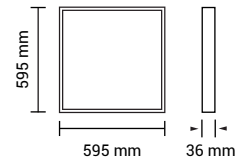

LED PANEL PF>0.9
36W With Driver 62x62cm

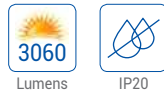

Product code	DL36-A3	Beam Angle	120°
Watts	36W	CRI	Ra>80
Input Voltage	AC : 175-265V	IP Rating	IP20
Flux	3060lm	BOX Qty	6 PCS



SKU: 2737	White Light	6000K	3800156627376
SKU: 2738	Neutral White	4500K	3800156627383
SKU: 2739	Warm White	2700K	3800156627390

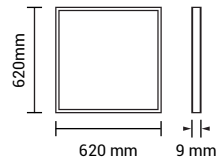

LED PANEL PF>0.9
45W With Driver 60x60cm



Product code	DL45-A5	Beam Angle	120°
Watts	45W	CRI	Ra>80
Input Voltage	AC : 175-265V	IP Rating	IP20
Flux	3600lm	BOX Qty	1 PCS

SKU: 2391	White Light	6000K	3800156623910
SKU: 2392	Neutral White	4500K	3800156623927
SKU: 2393	Warm White	2700K	3800156623934

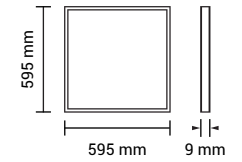

LED PANEL PF>0.9
40W With Driver 60x60cm



Product code	DL40-A1	Beam Angle	120°
Watts	40W	CRI	Ra>80
Input Voltage	AC : 175-265V	IP Rating	IP20
Flux	4800lm	BOX Qty	1 PCS



SKU: 2726	White Light	6000K	3800156627260
SKU: 2727	Neutral White	4500K	3800156627277
SKU: 2728	Warm White	2700K	3800156627284

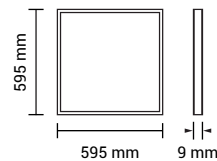

LED PANEL PF>0.9
45W With Driver 60x60cm



Product code	DL45-A1	Beam Angle	120°
Watts	45W	CRI	Ra>80
Input Voltage	AC : 175-265V	IP Rating	IP20
Flux	4500lm	BOX Qty	6 PCS



SKU: 2372	White Light	6000K	3800156623729
SKU: 2373	Neutral White	4500K	3800156623736
SKU: 2374	Warm White	2700K	3800156623743

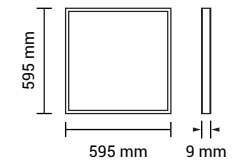

LED PANEL PF>0.9
45W With Driver 60x60cm



Product code	DL45-A5	Beam Angle	120°
Watts	45W	CRI	Ra>80
Input Voltage	AC : 175-265V	IP Rating	IP20
Flux	3600lm	BOX Qty	6 PCS



SKU: 2394	White Light	6000K	3800156623941
SKU: 2395	Neutral White	4500K	3800156623958
SKU: 2396	Warm White	2700K	3800156623965

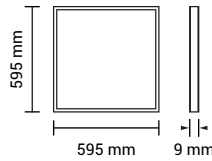

LED PANEL PF>0.9
45W With Driver 62x62cm

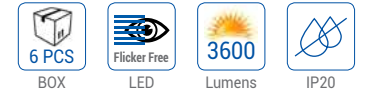

Product code	DL45-A5	Beam Angle	120°
Watts	45W	CRI	Ra>95
Input Voltage	AC : 175-265V	IP Rating	IP20
Flux	3600lm	BOX Qty	6 PCS

SKU: 2797	White Light	6000K	3800156627970
SKU: 2798	Neutral White	4500K	3800156627987
SKU: 2799	Warm White	2700K	3800156627994

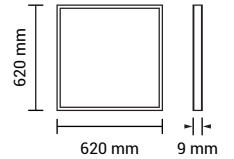

LED PANEL PF>0.9
45W With Driver 60x60cm

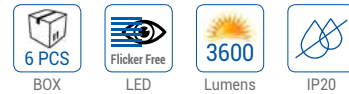

Product code	DL45-A5	Beam Angle	120°
Watts	45W	CRI	Ra>95
Input Voltage	AC : 175-265V	IP Rating	IP20
Flux	3600lm	BOX Qty	6 PCS

SKU: 2397	White Light	6000K	3800156623972
SKU: 2398	Neutral White	4500K	3800156623989
SKU: 2399	Warm White	2700K	3800156623996

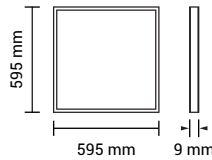

LED PANEL Single Pack PF>0.9
45W With Driver 62x62cm



Product code	DL45-A4	Beam Angle	120°
Watts	45W	CRI	Ra>80
Input Voltage	AC : 220-240V	IP Rating	IP20
Flux	3600lm	BOX Qty	1 PCS



SKU: 2791	White Light	6000K	3800156627918
SKU: 2792	Neutral White	4500K	3800156627925
SKU: 2793	Warm White	2700K	3800156627932

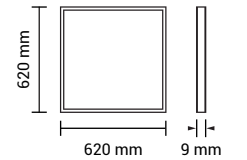

LED PANEL Single Pack PF>0.9
45W With Driver 62x62cm



Product code	DL45-A5	Beam Angle	120°
Watts	45W	CRI	Ra>80
Input Voltage	AC : 175-265V	IP Rating	IP20
Flux	3600lm	BOX Qty	1 PCS

SKU: 2788	White Light	6000K	3800156627888
SKU: 2789	Neutral White	4500K	3800156627895
SKU: 2790	Warm White	2700K	3800156627901

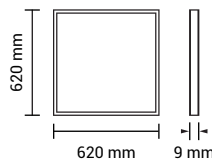

LED PANEL PF>0.9
45W With Driver 62x62cm



Product code	DL45-A4	Beam Angle	120°
Watts	45W	CRI	Ra>80
Input Voltage	AC : 175-265V	IP Rating	IP20
Flux	3600lm	BOX Qty	6 PCS



SKU: 2794	White Light	6000K	3800156627949
SKU: 2795	Neutral White	4500K	3800156627956
SKU: 2796	Warm White	2700K	3800156627963

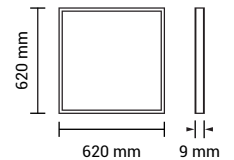

NEW



2 PCS
BOX

LED FRAME PANEL PF>0.9
36W With Driver 60x60cm

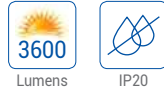

Product code	DL36-A4	Beam Angle	120°
Watts	36W	CRI	Ra>80
Input Voltage	AC : 220-240V	IP Rating	IP20
Flux	3600lm	BOX Qty	2 PCS

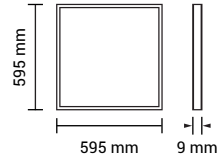

SKU: 2746 White Light 6000K 3800156627468

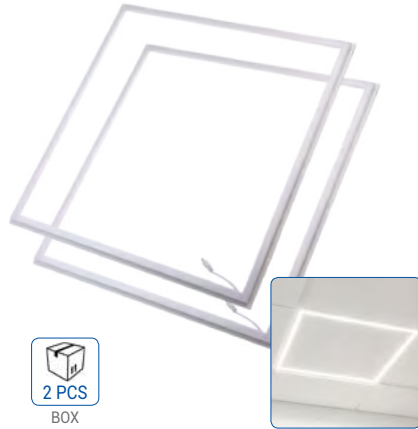

2 PCS
BOX

LED FRAME PANEL PF>0.9
45W With Driver 60x60cm

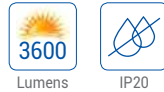

Product code	DL45-A2	Beam Angle	120°
Watts	45W	CRI	Ra>80
Input Voltage	AC : 220-240V	IP Rating	IP20
Flux	3600lm	BOX Qty	2 PCS

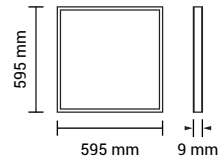

SKU: 2781 White Light 6000K 3800156627819
SKU: 2782 Neutral White 4500K 3800156627826



4 PCS
BOX

LED PANEL CLOUD OPTIC
45W With Driver 60x60cm

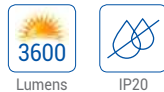

Product code	DL45-A3	Beam Angle	120°
Watts	45W	CRI	Ra>80
Input Voltage	AC : 220-240V	IP Rating	IP20
Flux	3600lm	BOX Qty	4 PCS

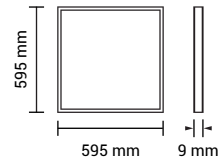

SKU: 2780 White Light 6000K 3800156627802



LED Panels are flat, their extremely thin profile is only made possible through the use of compact LEDs. The main advantage here is that the lamp itself – both modern and minimalist – takes a back seat, creating a tidier interior aesthetic. Because the light takes up very little space, it helps to make the room appear larger. As a result, LED panels work well even in the smallest of rooms.

LED PANEL PF>0.9
36W With Driver 120x30cm



Product code	DL36-A1	Beam Angle	120°
Watts	36W	CRI	Ra>80
Input Voltage	AC : 220-240V	IP Rating	IP20
Flux	3600lm	BOX Qty	6 PCS

SKU: 2714	White Light	6000K	3800156627147
SKU: 2715	Neutral White	4500K	3800156627154
SKU: 2716	Warm White	2700K	3800156627168

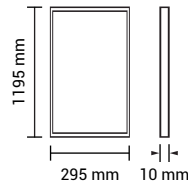

LED PANEL Single Pack PF>0.9
45W With Driver 120x30cm

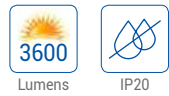

Product code	DL45-A1	Beam Angle	120°
Watts	45W	CRI	Ra>80
Input Voltage	AC : 220-240V	IP Rating	IP20
Flux	3600lm	BOX Qty	1 PCS

SKU: 2385	White Light	6000K	3800156623859
SKU: 2386	Neutral White	4500K	3800156623866
SKU: 2387	Warm White	2700K	3800156623873

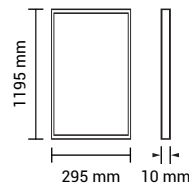

LED PANEL PF>0.9
45W With Driver 120x30cm



Product code	DL45-A1	Beam Angle	120°
Watts	45W	CRI	Ra>80
Input Voltage	AC : 220-240V	IP Rating	IP20
Flux	4500lm	BOX Qty	6 PCS

SKU: 2375	White Light	6000K	3800156623750
SKU: 2376	Neutral White	4500K	3800156623767
SKU: 2377	Warm White	2700K	3800156623774

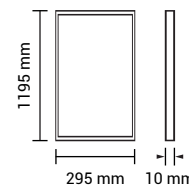

DRIVERS FOR LED PANELS
Dimmable



Watts	25W	36W	45W
Input Voltage	AC: 180-265V	AC: 180-265V	AC: 180-265V
Output Voltage	DC: 30-42V	DC: 30-42V	DC: 30-45V
Material	Plastic	Plastic	Plastic
IP Rating	IP20	IP20	IP20
Product code	AC1-A7	AC1-A8	AC1-A6

SKU: 6031	600mA	30-42V	25W	3800156660359
SKU: 6032	900mA	30-42V	36W	3800156660366
SKU: 6028	1000mA	30-45V	45W	3800156660373

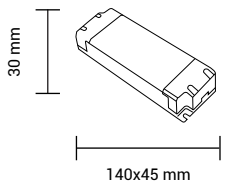

EMERGENCY BATTERY PACK
FOR LED PANELS

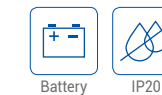

Product code	AC1-A9
Battery	3.6V / 4.5Ah
Material	Plastic
Dimension	213x95x40mm
Emergency duration	3 Hours
Dimensional	213x95x45mm

SKU: 6029 Battery Pack 3800156660359

LED DALI DRIVER - Adjustable
FOR LED PANELS



Watts	20-40W
Input Voltage	AC: 220-240V
Output Current	550mA-1050mA
Output Voltage	25V-42V
Material	Plastic
Dimensional	106x70x45mm

Emergency duration 3 Hours

SKU: 6030 20W-40W 3800156660304



DRIVERS FOR LED PANELS

Plastic Case



SKU: 6019	900mA	36W	3800156660199
SKU: 6021	950mA	45W	3800156660212
SKU: 6020	1150mA	48W	3800156660205
SKU: 6022	750mA	48W	3800156660229

Watts	36W	45W	48W	48W
Input Voltage	AC: 175-240V	AC: 175-240V	AC: 175-240V	AC: 175-240V
Output Current	900mA	950mA	1150mA	1150mA
Material	Plastic	Plastic	Plastic	Plastic
IP Rating	IP20	IP20	IP20	IP20
Product code	AC1-A8	AC1-A6	AC1-A5	AC1-A5

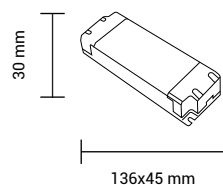

Accessories for Hanging

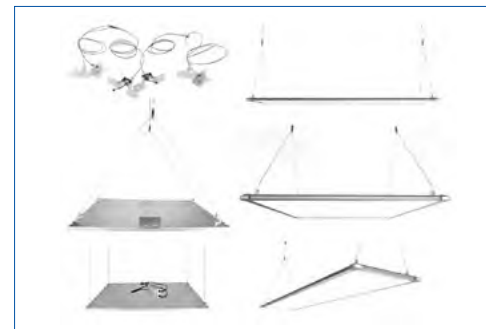

Stainless Steel Rope

SKU: 5182 3800156651821
Product code OT1-A2

Clips for LED Panels

SKU: 5188 3800156651883
Product code OT1-A2

DRIVERS FOR LED DOWNLIGHTS

Plastic Case



SKU: 6035	3-12V	3W	3800156660359
SKU: 6036	15-24V	6W	3800156660366
SKU: 6037	20-40V	12W	3800156660373
SKU: 6038	40-60V	18W	3800156660380
SKU: 6039	60-80V	24W	3800156660397

Watts	3W	6W	12W	18W	24W
Input Voltage	AC: 85-265V	AC: 85-265V	AC: 85-265V	AC: 85-265V	AC: 85-265V
Output Voltage	DC: 3-12V	DC: 15-24V	DC: 20-40V	DC: 40-60V	DC: 60-80V
Material	Plastic	Plastic	Plastic	Plastic	Plastic
IP Rating	IP20	IP20	IP20	IP20	IP20
Product code	AC1-B2	AC1-B3	AC1-B4	AC1-B5	AC1-B6

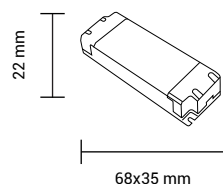

FRAMES FOR LED PANELS

SKU: 5198 Dimension 600x600mm 3800156651982
SKU: 5197 Dimension 300x1200mm 3800156651975

Product code OT1-A2





LED RECESSED PANELS

These LED mini panel lights are suitable for recessed installation in offices, hospitals, schools. Easy and quick mounting, there is no need of maintenance, offering long lifetime up of 25 000h

Features:

- Up to 80% power saving
- Different sizes to fit old installations or new lighting projects
- Build-in

Application:

- Home or office use
- Accent lights for shops or stores

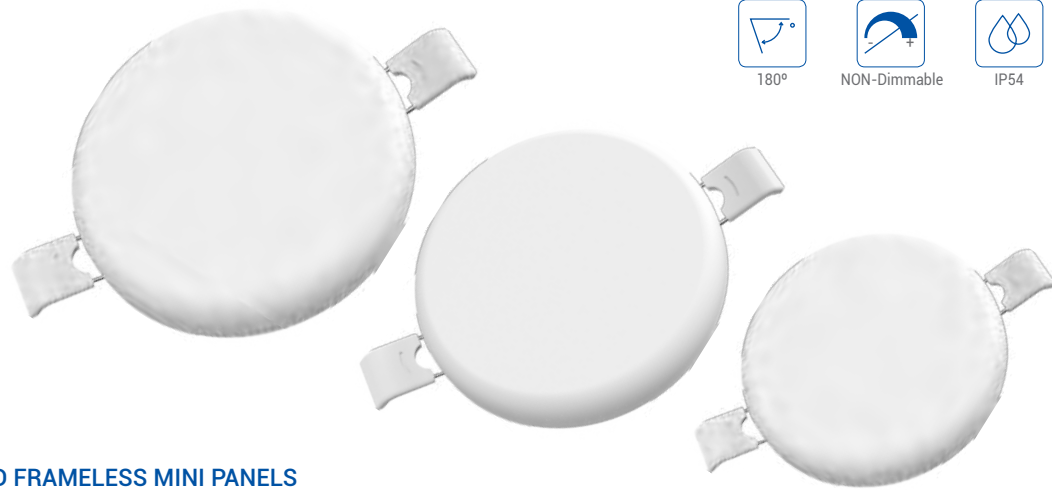

LED FRAMELESS MINI PANELS
ROUND

9W
760 Lumens

Product code DL9-B2
Watts 9W
Input Voltage AC : 85-265V
Flux 760lm

Beam Angle 180°
CRI Ra>80
IP Rating IP54
Cutting Size ø75mm

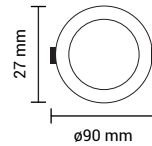

SKU: 2666 White Light 6000K 3800156626669
SKU: 2667 Neutral White 4200K 3800156626676
SKU: 2668 Warm White 2700K 3800156626683

18W
1500 Lumens

Product code DL18-B2
Watts 18W
Input Voltage AC : 85-265V
Flux 1500lm

Beam Angle 180°
CRI Ra>80
IP Rating IP54
Cutting Size ø108mm

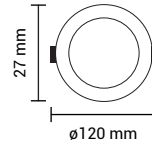

SKU: 2669 White Light 6000K 3800156626690
SKU: 2670 Neutral White 4200K 3800156626706
SKU: 2671 Warm White 2700K 3800156626713

24W
2010 Lumens

Product code DL24-B2
Watts 24W
Input Voltage AC : 85-265V
Flux 2010lm

Beam Angle 180°
CRI Ra>80
IP Rating IP54
Cutting Size ø155mm

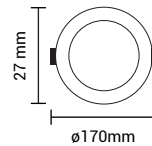

SKU: 2672 White Light 6000K 3800156626720
SKU: 2673 Neutral White 4200K 3800156626737
SKU: 2674 Warm White 2700K 3800156626744

36W
3020 Lumens

Product code DL36-B3
Watts 36W
Input Voltage AC : 85-265V
Flux 3020lm

Beam Angle 180°
CRI Ra>80
IP Rating IP54
Cutting Size ø206mm

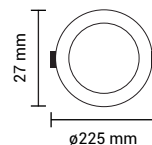

SKU: 2675 White Light 6000K 3800156626751
SKU: 2676 Neutral White 4200K 3800156626768
SKU: 2677 Warm White 2700K 3800156626775

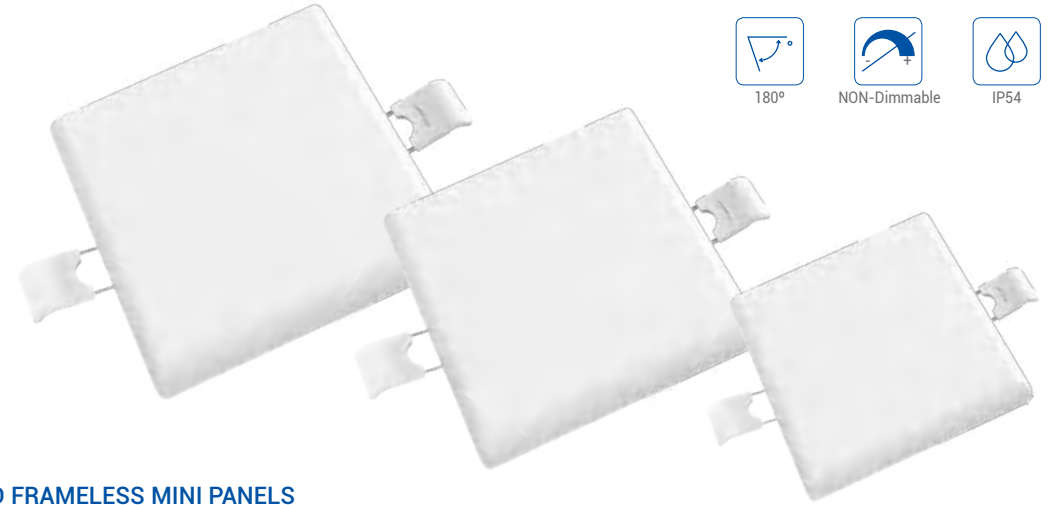

LED FRAMELESS MINI PANELS
SQUARE

9W
760 Lumens

Product code DL9-B2
Watts 9W
Input Voltage AC : 85-265V
Flux 760lm

Beam Angle 180°
CRI Ra>80
IP Rating IP54
Cutting Size 75x75mm

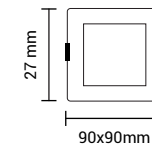

SKU: 2678 White Light 6000K 3800156626782
SKU: 2679 Neutral White 4200K 3800156626799
SKU: 2680 Warm White 2700K 3800156626805

18W
1500 Lumens

Product code DL18-B2
Watts 18W
Input Voltage AC : 85-265V
Flux 1500lm

Beam Angle 180°
CRI Ra>80
IP Rating IP54
Cutting Size 108x108mm

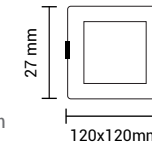

SKU: 2681 White Light 6000K 3800156626812
SKU: 2682 Neutral White 4200K 3800156626829
SKU: 2683 Warm White 2700K 3800156626836

24W
2010 Lumens

Product code DL24-B2
Watts 24W
Input Voltage AC : 85-265V
Flux 2010lm

Beam Angle 180°
CRI Ra>80
IP Rating IP54
Cutting Size 155x155mm

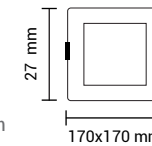

SKU: 2684 White Light 6000K 3800156626843
SKU: 2685 Neutral White 4200K 3800156626850
SKU: 2686 Warm White 2700K 3800156626857

36W
3020 Lumens

Product code DL36-B3
Watts 36W
Input Voltage AC : 85-265V
Flux 3020lm

Beam Angle 180°
CRI Ra>80
IP Rating IP54
Cutting Size 206x206mm

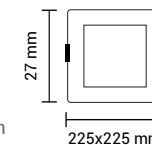

SKU: 2687 White Light 6000K 3800156626874
SKU: 2688 Neutral White 4200K 3800156626881
SKU: 2689 Warm White 2700K 3800156626898



LED MINI PANELS
ROUND - Pro Line
TRUE COLOURS SERIES

	6W	Product code	DL6-B3	Beam Angle	120°
	440	Watts	6W	CRI	Ra>95
	Lumens	Input Voltage	AC : 85-265V	IP Rating	IP20
		Flux	440lm	Cutting Size	ø100mm

SKU: 2601	White Light	6000K	3800156626010
SKU: 2602	Neutral White	4200K	3800156626027
SKU: 2603	Warm White	2700K	3800156626034

	12W	Product code	DL12-B3	Beam Angle	120°
	1000	Watts	12W	CRI	Ra>95
	Lumens	Input Voltage	AC : 85-265V	IP Rating	IP20
		Flux	1000lm	Cutting Size	ø150mm

SKU: 2604	White Light	6000K	3800156626041
SKU: 2605	Neutral White	4200K	3800156626058
SKU: 2606	Warm White	2700K	3800156626065

	18W	Product code	DL18-B3	Beam Angle	120°
	1500	Watts	18W	CRI	Ra>95
	Lumens	Input Voltage	AC : 85-265V	IP Rating	IP20
		Flux	1500lm	Cutting Size	ø200mm

SKU: 2608	White Light	6000K	3800156626089
SKU: 2609	Neutral White	4200K	3800156626096
SKU: 2610	Warm White	2700K	3800156626102

	24W	Product code	DL24-B3	Beam Angle	120°
	2010	Watts	24W	CRI	Ra>95
	Lumens	Input Voltage	AC : 85-265V	IP Rating	IP20
		Flux	2010lm	Cutting Size	ø270mm

SKU: 2611	White Light	6000K	3800156626119
SKU: 2612	Neutral White	4200K	3800156626126
SKU: 2613	Warm White	2700K	3800156626133



LED MINI PANELS
SQUARE - Pro Line
TRUE COLOURS SERIES

	6W	Product code	DL6-B3	Beam Angle	120°
	440	Watts	6W	CRI	Ra>95
	Lumens	Input Voltage	AC : 85-265V	IP Rating	IP20
		Flux	440lm	Cutting Size	95x95mm

SKU: 2614	White Light	6000K	3800156626140
SKU: 2615	Neutral White	4200K	3800156626157
SKU: 2616	Warm White	2700K	3800156626164

	12W	Product code	DL12-B3	Beam Angle	120°
	1000	Watts	12W	CRI	Ra>95
	Lumens	Input Voltage	AC : 85-265V	IP Rating	IP20
		Flux	1000lm	Cutting Size	150x150mm

SKU: 2617	White Light	6000K	3800156626171
SKU: 2618	Neutral White	4200K	3800156626188
SKU: 2619	Warm White	2700K	3800156626195

	18W	Product code	DL18-B3	Beam Angle	120°
	1500	Watts	18W	CRI	Ra>95
	Lumens	Input Voltage	AC : 85-265V	IP Rating	IP20
		Flux	1500lm	Cutting Size	200x200mm

SKU: 2630	White Light	6000K	3800156626300
SKU: 2631	Neutral White	4200K	3800156626317
SKU: 2632	Warm White	2700K	3800156626324

	24W	Product code	DL24-B3	Beam Angle	120°
	2010	Watts	24W	CRI	Ra>95
	Lumens	Input Voltage	AC : 85-265V	IP Rating	IP20
		Flux	2010lm	Cutting Size	270x270mm

SKU: 2642	White Light	6000K	3800156626423
SKU: 2643	Neutral White	4200K	3800156626430
SKU: 2644	Warm White	2700K	3800156626447



LED MINI PANELS
ROUND - Home Edition



Product code DL3-B1
Watts 3W
Input Voltage AC : 85-260V
Flux 150lm
Beam Angle 120°
CRI Ra>80
IP Rating IP20
Cutting Size ø62mm

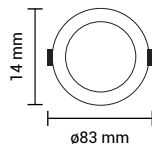

SKU: 2470 White Light 6000K 3800156624702
SKU: 2471 Neutral White 4500K 3800156624719
SKU: 2472 Warm White 2800K 3800156624726



Product code DL6-B1
Watts 6W
Input Voltage AC : 85-260V
Flux 360lm
Beam Angle 120°
CRI Ra>80
IP Rating IP20
Cutting Size ø99mm

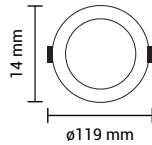

SKU: 2473 White Light 6000K 3800156624733
SKU: 2474 Neutral White 4500K 3800156624740
SKU: 2475 Warm White 2800K 3800156624757



Product code DL12-B1
Watts 12W
Input Voltage AC : 85-260V
Flux 840lm
Beam Angle 120°
CRI Ra>80
IP Rating IP20
Cutting Size ø146mm

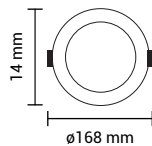

SKU: 2476 White Light 6000K 3800156624764
SKU: 2477 Neutral White 4500K 3800156624771
SKU: 2478 Warm White 2800K 3800156624788



Product code DL18-B1
Watts 18W
Input Voltage AC : 85-260V
Flux 1350lm
Beam Angle 120°
CRI Ra>80
IP Rating IP20
Cutting Size ø196mm

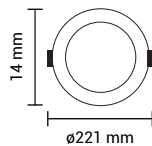

SKU: 2479 White Light 6000K 3800156624795
SKU: 2480 Neutral White 4500K 3800156624801
SKU: 2481 Warm White 2800K 3800156624818



Product code DL24-B1
Watts 24W
Input Voltage AC : 85-260V
Flux 1700lm
Beam Angle 120°
CRI Ra>80
IP Rating IP20
Cutting Size ø276mm

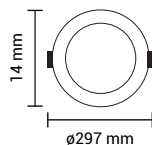

SKU: 2482 White Light 6000K 3800156624825
SKU: 2483 Neutral White 4500K 3800156624832
SKU: 2484 Warm White 2800K 3800156624849

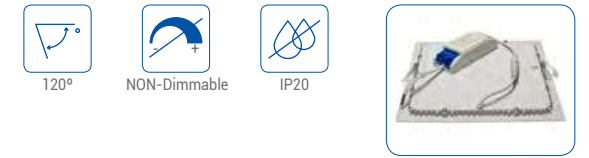

LED MINI PANELS
SQUARE - Home Edition



Product code DL3-B1
Watts 3W
Input Voltage AC : 85-260V
Flux 150lm
Beam Angle 120°
CRI Ra>80
IP Rating IP20
Cutting Size 67x67mm

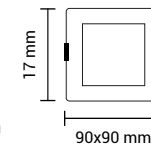

SKU: 2485 White Light 6000K 3800156624856
SKU: 2486 Neutral White 4500K 3800156624863
SKU: 2487 Warm White 2800K 3800156624870



Product code DL6-B1
Watts 6W
Input Voltage AC : 85-260V
Flux 360lm
Beam Angle 120°
CRI Ra>80
IP Rating IP20
Cutting Size 98x98mm

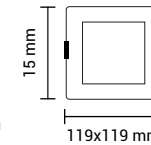

SKU: 2488 White Light 6000K 3800156624887
SKU: 2489 Neutral White 4500K 3800156624894
SKU: 2490 Warm White 2800K 3800156624900



Product code DL12-B1
Watts 12W
Input Voltage AC : 85-260V
Flux 840lm
Beam Angle 120°
CRI Ra>80
IP Rating IP20
Cutting Size 148x148mm

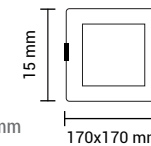

SKU: 2491 White Light 6000K 3800156624917
SKU: 2492 Neutral White 4500K 3800156624924
SKU: 2493 Warm White 2800K 3800156624931



Product code DL18-B1
Watts 18W
Input Voltage AC : 85-260V
Flux 1350lm
Beam Angle 120°
CRI Ra>80
IP Rating IP20
Cutting Size 198x198mm

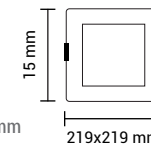

SKU: 2494 White Light 6000K 3800156624948
SKU: 2496 Neutral White 4500K 3800156624962
SKU: 2495 Warm White 2800K 3800156624955



Product code DL24-B1
Watts 24W
Input Voltage AC : 85-260V
Flux 1700lm
Beam Angle 120°
CRI Ra>80
IP Rating IP20
Cutting Size 270x270mm

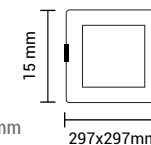

SKU: 2497 White Light 6000K 3800156624979
SKU: 2498 Neutral White 4500K 3800156624986
SKU: 2499 Warm White 2800K 3800156624993



3 Years Warranty

100° Beam Angle

IP44 Rating



Color Changing Knob

CCT - LED MINI PANELS
ROUND Build-in Driver

6W
450 Lumens

Product code	DL6-A6	Beam Angle	100°
Watts	6W	CRI	Ra>80
Input Voltage	AC : 165-265V	IP Rating	IP44 Front
Flux	450lm	Cutting Size	ø105mm

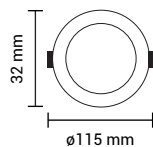

SKU: 2590 3800156625907

CCT

6000K 4500K 3000K

12W
950 Lumens

Product code	DL12-A6	Beam Angle	100°
Watts	12W	CRI	Ra>80
Input Voltage	AC : 165-265V	IP Rating	IP44 Front
Flux	950lm	Cutting Size	ø155mm

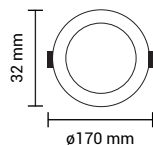

SKU: 2591 3800156625914

CCT

6000K 4500K 3000K

18W
1880 Lumens

Product code	DL18-A6	Beam Angle	100°
Watts	18W	CRI	Ra>80
Input Voltage	AC : 165-265V	IP Rating	IP44 Front
Flux	1880lm	Cutting Size	ø205mm

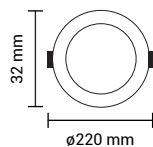

SKU: 2592 3800156625921

CCT

6000K 4500K 3000K

24W
2150 Lumens

Product code	DL24-A6	Beam Angle	100°
Watts	24W	CRI	Ra>80
Input Voltage	AC : 165-265V	IP Rating	IP44 Front
Flux	2150lm	Cutting Size	ø225mm

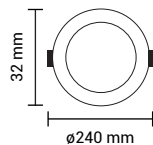

SKU: 2593 3800156625938

CCT

6000K 4500K 3000K



3 Years Warranty

120° Beam Angle

IP44 Rating



Color Changing Knob

CCT - LED MINI PANELS
SQUARE Build-in Driver

6W
450 Lumens

Product code	DL6-A6	Beam Angle	100°
Watts	6W	CRI	Ra>80
Input Voltage	AC : 165-265V	IP Rating	IP44 Front
Flux	450lm	Cutting Size	105x105mm

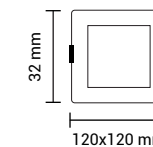

SKU: 2594 3800156625945

CCT

6000K 4500K 3000K

12W
950 Lumens

Product code	DL12-A6	Beam Angle	100°
Watts	12W	CRI	Ra>80
Input Voltage	AC : 165-265V	IP Rating	IP44 Front
Flux	950lm	Cutting Size	155x155mm

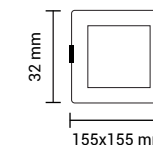

SKU: 2595 3800156625952

CCT

6000K 4500K 3000K

18W
1450 Lumens

Product code	DL18-A6	Beam Angle	100°
Watts	18W	CRI	Ra>80
Input Voltage	AC : 165-265V	IP Rating	IP44 Front
Flux	1450lm	Cutting Size	205x205mm

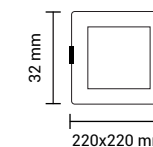

SKU: 2596 3800156625969

CCT

6000K 4500K 3000K

24W
2150 Lumens

Product code	DL24-A6	Beam Angle	100°
Watts	24W	CRI	Ra>80
Input Voltage	AC : 165-265V	IP Rating	IP44 Front
Flux	2150lm	Cutting Size	205x205mm

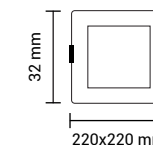

SKU: 2597 3800156625976

CCT

6000K 4500K 3000K



LED MINI PANELS
ROUND



Product code DL3-A4
Watts 3W
Input Voltage AC : 85-260V
Flux 150lm

Beam Angle 120°
CRI Ra>80
IP Rating IP20
Cutting Size ø80mm

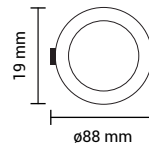

SKU: 2431 White Light 6000K 3800156624313
SKU: 2432 Neutral White 4500K 3800156624320
SKU: 2433 Warm White 2700K 3800156624337



Product code DL6-A4
Watts 6W
Input Voltage AC : 85-260V
Flux 360lm

Beam Angle 120°
CRI Ra>80
IP Rating IP20
Cutting Size ø110mm

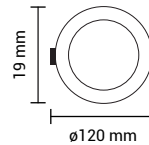

SKU: 2434 White Light 6000K 3800156624344
SKU: 2435 Neutral White 4500K 3800156624351
SKU: 2436 Warm White 2700K 3800156624368



Product code DL12-A4
Watts 12W
Input Voltage AC : 85-260V
Flux 840lm

Beam Angle 120°
CRI Ra>80
IP Rating IP20
Cutting Size ø155mm

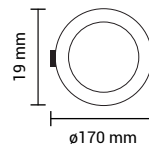

SKU: 2437 White Light 6000K 3800156624375
SKU: 2438 Neutral White 4500K 3800156624382
SKU: 2439 Warm White 2700K 3800156624399



Product code DL18-A4
Watts 18W
Input Voltage AC : 85-260V
Flux 1350lm

Beam Angle 120°
CRI Ra>80
IP Rating IP20
Cutting Size ø205mm

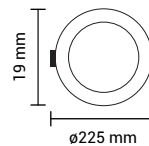

SKU: 2335 White Light 6000K 3800156623354
SKU: 2440 Neutral White 4500K 3800156624405
SKU: 2336 Warm White 2700K 3800156623361



Product code DL24-A4
Watts 24W
Input Voltage AC : 85-260V
Flux 1700lm

Beam Angle 120°
CRI Ra>80
IP Rating IP20
Cutting Size ø285mm

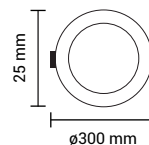

SKU: 2441 White Light 6000K 3800156624412
SKU: 2442 Neutral White 4500K 3800156624429
SKU: 2443 Warm White 2700K 3800156624436



LED MINI PANELS
SQUARE



Product code DL3-A4
Watts 3W
Input Voltage AC : 85-260V
Flux 150lm

Beam Angle 120°
CRI Ra>80
IP Rating IP20
Cutting Size 75x75mm

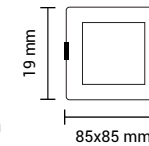

SKU: 2444 White Light 6000K 3800156624443
SKU: 2445 Neutral White 4500K 3800156624450
SKU: 2446 Warm White 2700K 3800156624467



Product code DL6-A4
Watts 6W
Input Voltage AC : 85-260V
Flux 360lm

Beam Angle 120°
CRI Ra>80
IP Rating IP20
Cutting Size 110x110mm

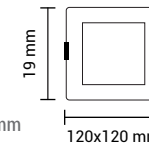

SKU: 2447 White Light 6000K 3800156624474
SKU: 2448 Neutral White 4500K 3800156624481
SKU: 2449 Warm White 2700K 3800156624498



Product code DL12-A4
Watts 12W
Input Voltage AC : 85-260V
Flux 840lm

Beam Angle 120°
CRI Ra>80
IP Rating IP20
Cutting Size 155x155mm

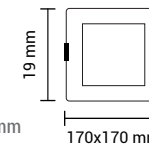

SKU: 2450 White Light 6000K 3800156624504
SKU: 2451 Neutral White 4500K 3800156624511
SKU: 2452 Warm White 2700K 3800156624528



Product code DL18-A4
Watts 18W
Input Voltage AC : 85-260V
Flux 1350lm

Beam Angle 120°
CRI Ra>80
IP Rating IP20
Cutting Size 205x205mm

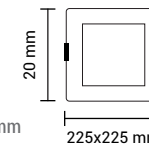

SKU: 2348 White Light 6000K 3800156623484
SKU: 2453 Neutral White 4500K 3800156624535
SKU: 2349 Warm White 2700K 3800156623491



Product code DL24-A4
Watts 24W
Input Voltage AC : 85-260V
Flux 1700lm

Beam Angle 120°
CRI Ra>80
IP Rating IP20
Cutting Size 282x282mm

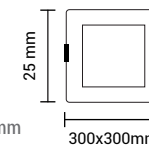

SKU: 2454 White Light 6000K 3800156624542
SKU: 2455 Neutral White 4500K 3800156624559
SKU: 2456 Warm White 2700K 3800156624566



Color Changing Knob



CCT - LED MINI PANELS

ROUND Build-in Driver - Dimmable



Product code DL6-A7
Watts 6W
Input Voltage AC : 220-240V
Flux 450lm
Beam Angle 100°
CRI Ra>80
IP Rating IP44 Front
Cutting Size ø105mm

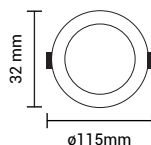

SKU: 2581 3800156625815
 CCT
 6000K 4500K 3000K



Product code DL9-A7
Watts 9W
Input Voltage AC : 220-240V
Flux 650lm
Beam Angle 100°
CRI Ra>80
IP Rating IP44 Front
Cutting Size ø105mm

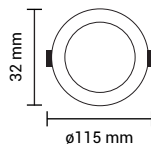

SKU: 2582 3800156625822
 CCT
 6000K 4500K 3000K



Product code DL16-A7
Watts 12W
Input Voltage AC : 220-240V
Flux 900lm
Beam Angle 100°
CRI Ra>80
IP Rating IP44 Front
Cutting Size ø155mm

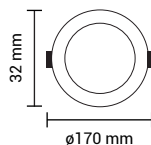

SKU: 2583 3800156625839
 CCT
 6000K 4500K 3000K



Product code DL20-A7
Watts 20W
Input Voltage AC : 220-240V
Flux 1600lm
Beam Angle 100°
CRI Ra>80
IP Rating IP44 Front
Cutting Size ø205mm

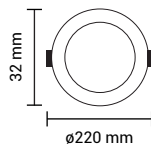

SKU: 2584 3800156625846
 CCT
 6000K 4500K 3000K



Product code DL24-A7
Watts 24W
Input Voltage AC : 220-240V
Flux 2100lm
Beam Angle 100°
CRI Ra>80
IP Rating IP44 Front
Cutting Size ø225mm

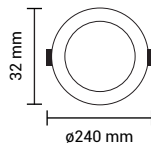

SKU: 2585 3800156625853
 CCT
 6000K 4500K 3000K



Downlight Adapter

Recessed Panel to Surface Panel

SKU: 5003 3800156650039
 Surface 3'D105 from 6-9W
 Compatible with SKU: 2581, 2582

SKU: 5004 3800156650046
 Surface 3'D105 from 12-16W
 Compatible with SKU: 2583

SKU: 5005 3800156650053
 Surface 7'D205 from 18-20W
 Compatible with SKU: 2584

SKU: 5006 3800156650060
 Surface 8'D225 from 22-24W
 Compatible with SKU: 2585

Mini Panels Dimmable Drivers



SKU: 6025 3800156660250
 Dimmable Driver 220V 5-9*1W 300mA

SKU: 6026 3800156660267
 Dimmable Driver 220V 10-18*1W 300mA

SKU: 6027 3800156660274
 Dimmable Driver 220V 20-30*1W 300mA



Slidable spring

Color Changing Knob

**LED SLIM 5 in 1 BUILD-IN/SURFACE
CCT LED 3000 to 6000K**



**LED DOWNLIGHT Dimmable
CCT LED 3000 to 6000K**

Remote Control 6324 - NOT INCLUDED



Remote Control



SKU: 6324 3800156663244

18W
1600 Lumens

Product code	DL18-A7	Beam Angle	100°
Watts	18W	CRI	Ra>80
Input Voltage	AC : 175-265V	IP Rating	IP20
Flux	1600lm	Cutting Size	ø65-210mm

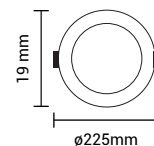

SKU: 2586 3800156625860

CCT

6000K 4500K 3000K

12W
750 Lumens

Product code	CB12-A2	Beam Angle	120°
Watts	12W	CRI	Ra>80
Input Voltage	AC : 175-265V	IP Rating	IP50
Flux	750lm	Cutting Size	ø100mm

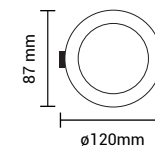

SKU: 3257 3800156632578

CCT

6000K 4500K 3000K

30W
3000 Lumens

Product code	DL30-A7	Beam Angle	100°
Watts	30W	CRI	Ra>80
Input Voltage	AC : 175-265V	IP Rating	IP20
Flux	3000lm	Cutting Size	ø65-310mm

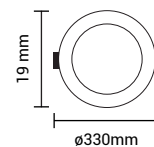

SKU: 2587 3800156625877

CCT

6000K 4500K 3000K

20W
1400 Lumens

Product code	CB20-A2	Beam Angle	120°
Watts	20W	CRI	Ra>80
Input Voltage	AC : 175-265V	IP Rating	IP50
Flux	1400lm	Cutting Size	ø160mm

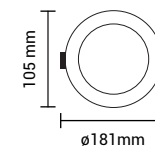

SKU: 3258 3800156632585

CCT

6000K 4500K 3000K

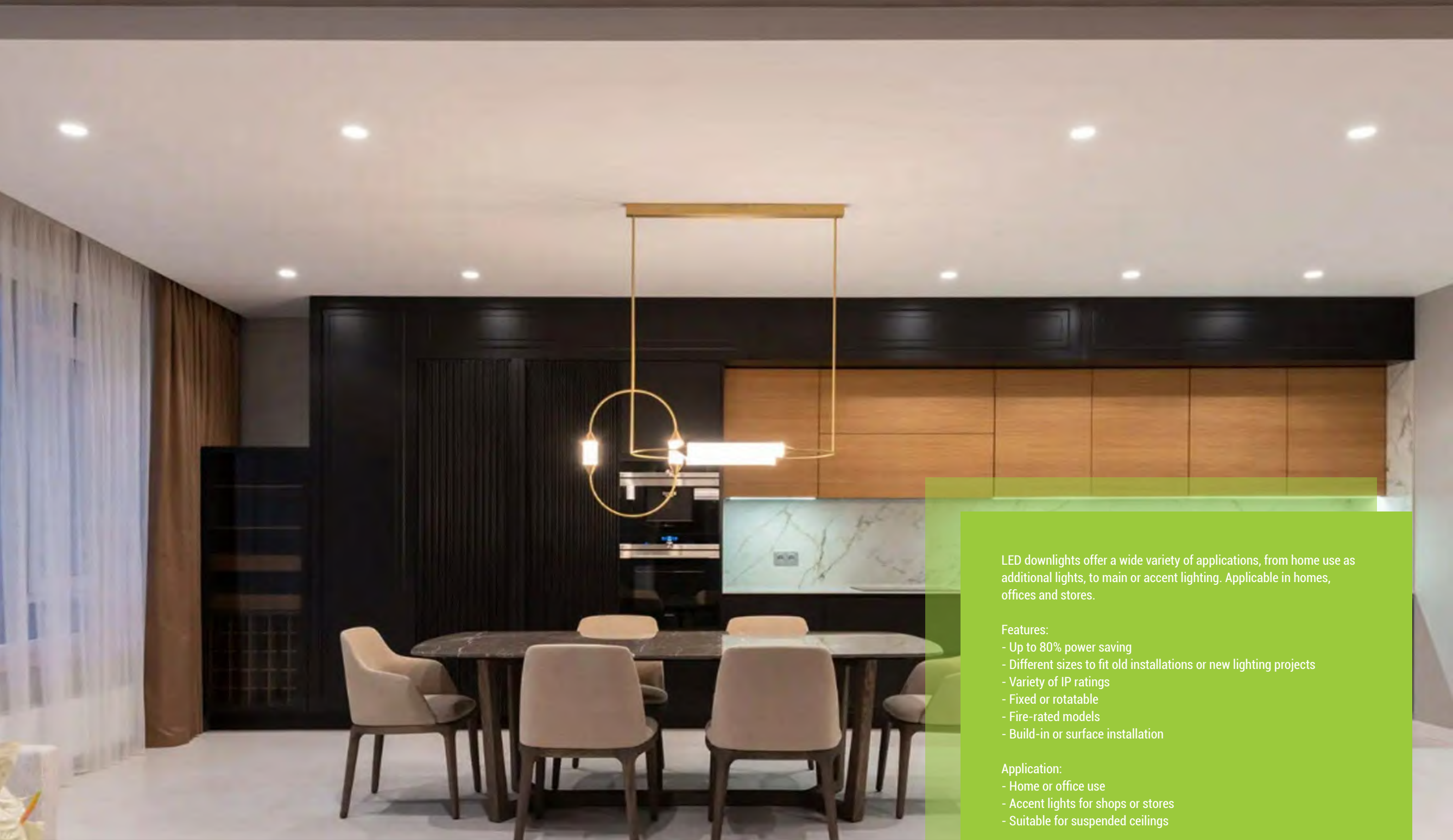

LED downlights offer a wide variety of applications, from home use as additional lights, to main or accent lighting. Applicable in homes, offices and stores.

Features:

- Up to 80% power saving
- Different sizes to fit old installations or new lighting projects
- Variety of IP ratings
- Fixed or rotatable
- Fire-rated models
- Build-in or surface installation

Application:

- Home or office use
- Accent lights for shops or stores
- Suitable for suspended ceilings

LED DOWNLIGHTS

**LED COB Downlight
5W Adjustable**

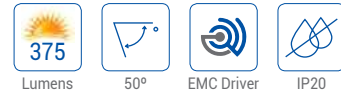

Product code	CB5-A1	CRI	Ra>80
Watts	5W	IP Rating	IP20
Input Voltage	AC : 100-240V	Cutting Size	ø80
Flux	375lm	Body Color	White
Beam Angle	50°	Dimmable	NO

SKU: 3264	White Light	6000K	3800156632646
SKU: 3265	Neutral White	4500K	3800156632653
SKU: 3266	Warm White	2700K	3800156632660

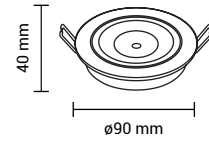

**LED COB Downlight
5W Adjustable**



Product code	CB5-A1	CRI	Ra>80
Watts	5W	IP Rating	IP20
Input Voltage	AC : 100-240V	Cutting Size	ø80
Flux	375lm	Body Color	White
Beam Angle	50°	Dimmable	NO

SKU: 3267	White Light	6000K	3800156632677
SKU: 3268	Neutral White	4500K	3800156632684
SKU: 3269	Warm White	2700K	3800156632691

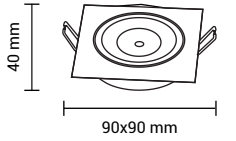

**LED COB Downlight
7W Adjustable**

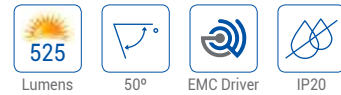

Product code	CB7-A1	CRI	Ra>80
Watts	7W	IP Rating	IP20
Input Voltage	AC : 100-240V	Cutting Size	ø80
Flux	525lm	Body Color	White
Beam Angle	50°	Dimmable	NO

SKU: 3284	White Light	6000K	3800156632844
SKU: 3285	Neutral White	4500K	3800156632851
SKU: 3286	Warm White	2700K	3800156632868

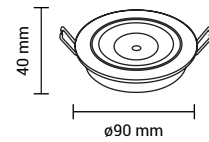

**LED COB Downlight
7W Adjustable**

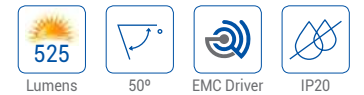

Product code	CB7-A1	CRI	Ra>80
Watts	7W	IP Rating	IP20
Input Voltage	AC : 100-240V	Cutting Size	ø80
Flux	525lm	Body Color	White
Beam Angle	50°	Dimmable	NO

SKU: 3287	White Light	6000K	3800156632875
SKU: 3288	Neutral White	4500K	3800156632882
SKU: 3289	Warm White	2700K	3800156632899

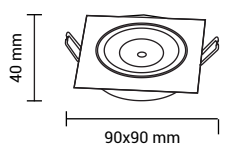

**LED COB Downlight
10W Adjustable**

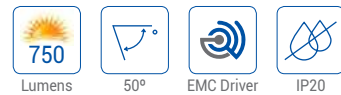

Product code	CB10-A1	CRI	Ra>80
Watts	10W	IP Rating	IP20
Input Voltage	AC : 100-240V	Cutting Size	ø105
Flux	750lm	Body Color	White
Beam Angle	50°	Dimmable	NO

SKU: 3290	White Light	6000K	3800156632905
SKU: 3291	Neutral White	4500K	3800156632912
SKU: 3292	Warm White	2700K	3800156632929

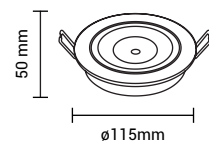

**LED COB Downlight
10W Adjustable**

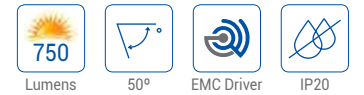

Product code	CB10-A1	CRI	Ra>80
Watts	10W	IP Rating	IP20
Input Voltage	AC : 100-240V	Cutting Size	ø105
Flux	750lm	Body Color	White
Beam Angle	50°	Dimmable	NO

SKU: 3293	White Light	6000K	3800156632936
SKU: 3294	Neutral White	4500K	3800156632943
SKU: 3295	Warm White	2700K	3800156632950

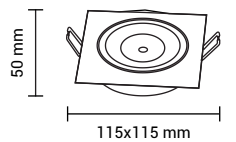



**LED COB Downlight
8W Adjustable**

Product code CB8-A1 CRI Ra>80
 Watts 8W IP Rating IP20
 Input Voltage AC : 220-265V Cutting Size ø80
 Flux 560lm Body Color White
 Beam Angle 60° Dimmable NO

SKU: 3201 White Light 6000K 3800156632011
 SKU: 3206 Neutral White 4500K 3800156632066
 SKU: 3202 Warm White 2700K 3800156632028

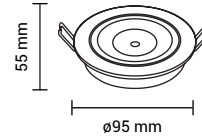
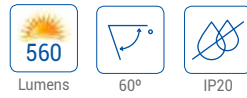

**LED COB Downlight
12W Adjustable**

Product code CB12-A1 CRI Ra>80
 Watts 12W IP Rating IP20
 Input Voltage AC : 200-265V Cutting Size ø105
 Flux 960lm Body Color White
 Beam Angle 60° Dimmable NO

SKU: 3251 White Light 6000K 3800156632516
 SKU: 3252 Neutral White 4500K 3800156632523
 SKU: 3253 Warm White 2700K 3800156632530

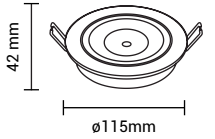

**LED COB Downlight
8W Adjustable**

Product code CB8-A1 CRI Ra>80
 Watts 8W IP Rating IP20
 Input Voltage AC : 220-265V Cutting Size ø80
 Flux 560lm Body Color Inox
 Beam Angle 60° Dimmable NO

SKU: 3203 White Light 6000K 3800156632035
 SKU: 3205 Neutral White 4500K 3800156632059
 SKU: 3204 Warm White 2700K 3800156632042

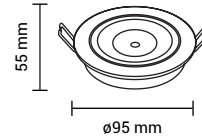
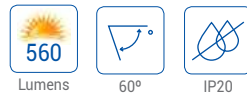

**LED COB Downlight
12W Adjustable**



Product code CB12-A1 CRI Ra>80
 Watts 12W IP Rating IP20
 Input Voltage AC : 220-265V Cutting Size ø105
 Flux 960lm Body Color Inox
 Beam Angle 60° Dimmable NO

SKU: 3254 White Light 6000K 3800156632547
 SKU: 3255 Neutral White 4500K 3800156632554
 SKU: 3256 Warm White 2700K 3800156632561

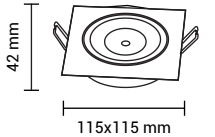
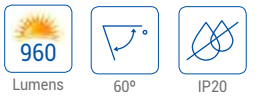

**LED COB Downlight
8W Adjustable**

Product code CB8-A1 CRI Ra>80
 Watts 8W IP Rating IP20
 Input Voltage AC : 220-265V Cutting Size ø80
 Flux 560lm Body Color White
 Beam Angle 60° Dimmable NO

SKU: 3207 White Light 6000K 3800156632073
 SKU: 3222 Neutral White 4500K 3800156632226
 SKU: 3212 Warm White 2700K 3800156632127

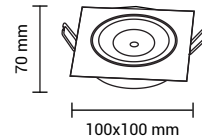

**LED COB Downlight
25W Adjustable**



Product code CB25-A1 CRI Ra>80
 Watts 25W IP Rating IP20
 Input Voltage AC : 220-240V Cutting Size ø160
 Flux 2200lm Body Color White
 Beam Angle 60° Dimmable NO

SKU: 3241 White Light 6000K 3800156632417
 SKU: 3242 Neutral White 4500K 3800156632424

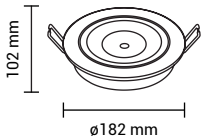
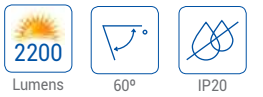

**LED COB Downlight
8W Adjustable**

Product code CB8-A1 CRI Ra>80
 Watts 8W IP Rating IP20
 Input Voltage AC : 220-265V Cutting Size ø80
 Flux 560lm Body Color Inox
 Beam Angle 60° Dimmable NO

SKU: 3223 White Light 6000K 3800156632233
 SKU: 3224 Neutral White 4500K 3800156632240
 SKU: 3225 Warm White 2700K 3800156632257

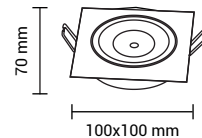
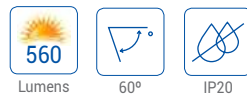

**LED COB Downlight
35W Adjustable**



Product code CB35-A1 CRI Ra>80
 Watts 35W IP Rating IP20
 Input Voltage AC : 220-240V Cutting Size ø210
 Flux 3000lm Body Color Inox
 Beam Angle 60° Dimmable NO

SKU: 3243 White Light 6000K 3800156632431

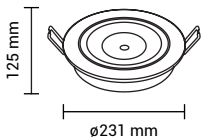
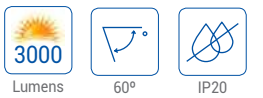

**LED COB Downlight
15W - TÜV**



Product code	CB15-A2	CRI	Ra>80
Watts	15W	IP Rating	IP20
Input Voltage	AC : 220-240V	Cutting Size	ø155
Flux	1200lm	Body Color	White
Beam Angle	145°	Dimmable	NO

SKU: 3270	White Light	6000K	3800156632707
SKU: 3271	Neutral White	4500K	3800156632714
SKU: 3272	Warm White	2700K	3800156632721

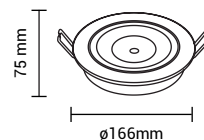

**LED COB Downlight
40W - TÜV**



Product code	CB40-A2	CRI	Ra>80
Watts	40W	IP Rating	IP20
Input Voltage	AC : 100-240V	Cutting Size	ø175
Flux	4000lm	Body Color	White
Beam Angle	60°	Dimmable	NO

SKU: 3260	White Light	6000K	3800156632608
SKU: 3261	Neutral White	4500K	3800156632615

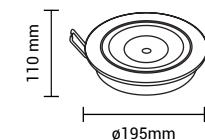

**LED COB Downlight
20W - TÜV**



Product code	CB20-A2	CRI	Ra>80
Watts	20W	IP Rating	IP20
Input Voltage	AC : 220-240V	Cutting Size	ø165
Flux	1600lm	Body Color	White
Beam Angle	145°	Dimmable	NO

SKU: 3273	White Light	6000K	3800156632738
SKU: 3274	Neutral White	4500K	3800156632745
SKU: 3275	Warm White	2700K	3800156632752

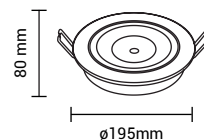

**LED COB Downlight
60W - TÜV**



Product code	CB60-A1	CRI	Ra>80
Watts	60W	IP Rating	IP20
Input Voltage	AC : 100-240V	Cutting Size	ø205
Flux	5600lm	Body Color	White
Beam Angle	60°	Dimmable	NO

SKU: 3262	White Light	6000K	3800156632622
SKU: 3263	Neutral White	4500K	3800156632639

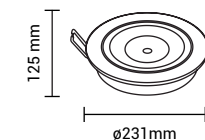

**LED COB Downlight
30W - TÜV**



Product code	CB30-A2	CRI	Ra>80
Watts	30W	IP Rating	IP20
Input Voltage	AC : 220-240V	Cutting Size	ø195
Flux	2500lm	Body Color	White
Beam Angle	145°	Dimmable	NO

SKU: 3276	White Light	6000K	3800156632769
SKU: 3277	Neutral White	4500K	3800156632776
SKU: 3278	Warm White	2700K	3800156632783

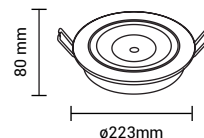



LED SMD FIRE-RATED PF>0.9
10W - CCT 3000K to 6000K

Product code	OT10-A1	CRI	Ra>80
Watts	10W	IP Rating	IP65
Input Voltage	AC : 200-240V	Cutting Size	ø60
Flux	750lm	Dimension	ø84x67mm
Beam Angle	40°	Dimmable	YES



CCT Knob

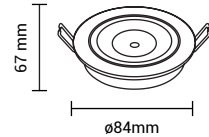

LED SMD FIRE-RATED PF>0.9
6W - Replaceable covers

Product code	OT6-A2	CRI	Ra>80
Watts	6W	IP Rating	IP65
Input Voltage	AC : 200-265V	Cutting Size	ø60
Flux	540lm	Dimension	ø84x67mm
Beam Angle	40°	Dimmable	YES

SKU: 5042	Neutral White	4000K	3800156650428
SKU: 5041	Warm White	3000K	3800156650411



Magnetic replaceable covers



BEZELS FOR LED FIRE-RATED DOWNLIGHT
Magnetic

SKU: 5045	OT1-A8	CHROME BEZEL	3800156650435
SKU: 5046	OT1-A8	BRUSHED BEZEL	3800156650435

MAGNETIC CHROME BEZEL FOR 5044

MAGNETIC BRUSHED BEZEL FOR 5044



SKU: 5045



SKU: 5046



LED SMD FIRE-RATED PF>0.9
8W - CCT 3000K to 6000K

Product code	OT8-A1	CRI	Ra>80
Watts	8W	IP Rating	IP65
Input Voltage	AC : 175-265V	Cutting Size	ø65
Flux	570-630lm	Dimension	ø80x80mm
Beam Angle	40°	Dimmable	YES



CCT Knob



Magnetic replaceable covers



LED Strips are a flexible solution for wide variety of lighting applications, both for indoor and outdoor projects, allowing for variable shapes and abstract forms. Functioning as a core or supplementary lighting, LED strips become a common choice of lighting professionals.

Features:

- Up to 80% power saving
- Flexible and reliable
- Wide choice of colour – single colour light to RGB
- Variety of IP ratings
- Options for dimming and control

Application:

- Indoor and outdoor lighting projects
- Applicable for abstract forms and shapes
- Hidden or ambient light

LED STRIPS AND ACCESSORIES

LED Strip 12V 2835 60 LEDs
4.8W/m - Non Waterproof



Product code	ST2835-A1	LED Qty	60 SMD/m
Type LED	SMD 2835	Material	Flex PCB
Power/Meter	4.8W/m	Beam Angle	120°
Voltage	DC: 12V	IP Rating	IP20
Flux/Meter	300lm/m	Width	8mm

SKU: 4702	White Light	6000K	3800156647022
SKU: 4700	Neutral White	4500K	3800156647008
SKU: 4703	Warm White	2700K	3800156647039



LED Strip 12V 2835 60 LEDs
4.8W/m - Non Waterproof



Product code	ST2835-A1	LED Qty	60 SMD/m
Type LED	SMD 2835	Material	Flex PCB
Power/Meter	4.8W/m	Beam Angle	120°
Voltage	DC: 12V	IP Rating	IP20
Flux/Meter	300lm/m	Width	8mm

SKU: 4704	RED	3800156647046
SKU: 4706	BLUE	3800156647060



LED Strip 12V 2835 120 LEDs
9.6W/m - Non Waterproof



Product code	ST2835-A1	LED Qty	120 SMD/m
Type LED	SMD 2835	Material	Flex PCB
Power/Meter	9.6W/m	Beam Angle	120°
Voltage	DC: 12V	IP Rating	IP20
Flux/Meter	600lm/m	Width	8mm

SKU: 4710	White Light	6000K	3800156647107
SKU: 4740	Neutral White	4500K	3800156647404
SKU: 4711	Warm White	2700K	3800156647114



LED Strip 12V 2835 204 LEDs
16.5W/m - Non Waterproof



Product code	ST2835-A1	LED Qty	204 SMD/m
Type LED	SMD 2835	Material	Flex PCB
Power/Meter	16.5W/m	Beam Angle	120°
Voltage	DC: 12V	IP Rating	IP20
Flux/Meter	1700lm/m	Width	10mm

SKU: 4761	White Light	6000K	3800156647619
SKU: 4762	Neutral White	4500K	3800156647626
SKU: 4763	Warm White	2700K	3800156647633



LED Strip 12V 5050 60 LEDs
14.4W/m - Non Waterproof



Product code	ST5050-A1	LED Qty	60 SMD/m
Type LED	SMD 5050	Material	Flex PCB
Power/Meter	14.4W/m	Beam Angle	120°
Voltage	DC: 12V	IP Rating	IP20
Flux/Meter	1000lm/m	Width	12mm

SKU: 4313	RGB+White Light	3800156643130
-----------	-----------------	---------------



LED Strip 12V 5050 60 LEDs
14.4W/m - Non Waterproof



Product code	ST5050-A1	LED Qty	60 SMD/m
Type LED	SMD 5050	Material	Flex PCB
Power/Meter	14.4W/m	Beam Angle	120°
Voltage	DC: 12V	IP Rating	IP20
Flux/Meter	1000lm/m	Width	12mm

SKU: 4314	RGB+Warm White	3800156643147
-----------	----------------	---------------



LED Strip 12V 2835 60 LEDs
4.8W/m - Waterproof

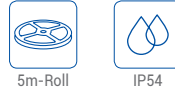

Product code	ST2835-A2	LED Qty	60 SMD/m
Type LED	SMD 2835	Material	Flex PCB
Power/Meter	4.8W/m	Beam Angle	120°
Voltage	DC: 12V	IP Rating	IP54
Flux/Meter	300lm/m	Width	8mm

SKU: 4732	White Light	6000K	3800156647329
SKU: 4731	Neutral White	4500K	3800156647312
SKU: 4733	Warm White	2700K	3800156647336



LED Strip 12V 2835 60 LEDs
4.8W/m - Waterproof

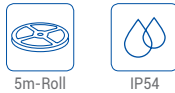

Product code	ST2835-A2	LED Qty	60 SMD/m
Type LED	SMD 2835	Material	Flex PCB
Power/Meter	4.8W/m	Beam Angle	120°
Voltage	DC: 12V	IP Rating	IP54
Flux/Meter	300lm/m	Width	8mm

SKU: 4734	RED	3800156647343
SKU: 4735	GREEN	3800156647350
SKU: 4736	BLUE	3800156647367



LED Strip 12V 2835 120 LEDs
9.6W/m - Waterproof

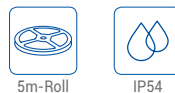

Product code	ST2835-A2	LED Qty	120 SMD/m
Type LED	SMD 2835	Material	Flex PCB
Power/Meter	9.6W/m	Beam Angle	120°
Voltage	DC: 12V	IP Rating	IP54
Flux/Meter	600lm/m	Width	8mm

SKU: 4720	White Light	6000K	3800156647206
SKU: 4721	Warm White	2700K	3800156647213



LED Strip 12V 5050 30 LEDs
7.2W/m - Non Waterproof



Product code	ST5050-A1	LED Qty	30 SMD/m
Type LED	SMD 5050	Material	Flex PCB
Power/Meter	7.2W/m	Beam Angle	120°
Voltage	DC: 12V	IP Rating	IP20
Flux/Meter	500lm/m	Width	10mm

SKU: 4801	White Light	6000K	3800156648012
SKU: 4800	Neutral White	4500K	3800156648005
SKU: 4802	Warm White	2700K	3800156648029



LED Strip 12V 5050 60 LEDs
14.4W/m - Non Waterproof



Product code	ST5050-A1	LED Qty	60 SMD/m
Type LED	SMD 5050	Material	Flex PCB
Power/Meter	14.4W/m	Beam Angle	120°
Voltage	DC: 12V	IP Rating	IP20
Flux/Meter	1000lm/m	Width	10mm

SKU: 4807	White Light	6000K	3800156648074
SKU: 4827	Neutral White	4500K	3800156648272
SKU: 4808	Warm White	2700K	3800156648081



LED Strip 12V 5050 60 LEDs
14.4W/m - Non Waterproof



Product code	ST5050-A1	LED Qty	60 SMD/m
Type LED	SMD 5050	Material	Flex PCB
Power/Meter	14.4W/m	Beam Angle	120°
Voltage	DC: 12V	IP Rating	IP20
Flux/Meter	1000lm/m	Width	10mm

SKU: 4823	RED	3800156648234
SKU: 4825	BLUE	3800156648258



LED Strip 12V 5050 30 LEDs
7.2W/m - Waterproof



Product code	ST5050-A2	LED Qty	30 SMD/m
Type LED	SMD 5050	Material	Flex PCB
Power/Meter	7.2W/m	Beam Angle	120°
Voltage	DC: 12V	IP Rating	IP54
Flux/Meter	500lm/m	Width	10mm

SKU: 4809	White Light	6000K	3800156648098
SKU: 4811	Neutral White	4500K	3800156648111
SKU: 4810	Warm White	2700K	3800156648104



LED Strip 12V 5050 30 LEDs
7.2W/m



Product code	ST5050-A1	LED Qty	30 SMD/m
Type LED	SMD 5050	Material	Flex PCB
Power/Meter	7.2W/m	Beam Angle	120°
Voltage	DC: 12V	IP Rating	IP20 ; IP54
Flux/Meter	500lm/m	Width	10mm

SKU: 4311	RGB	3800156643116	IP20
SKU: 4315	RGB	3800156643154	IP54



LED Strip 12V 5050 60 LEDs
14.4W/m - Waterproof



Product code	ST5050-A2	LED Qty	60 SMD/m
Type LED	SMD 5050	Material	Flex PCB
Power/Meter	14.4W/m	Beam Angle	120°
Voltage	DC: 12V	IP Rating	IP54
Flux/Meter	1000lm/m	Width	10mm

SKU: 4839	White Light	6000K	3800156648395
SKU: 4841	Neutral White	4500K	3800156648418
SKU: 4840	Warm White	2700K	3800156648401



LED Strip 12V 5050 60 LEDs
14.4W/m



Product code	ST5050-A1	LED Qty	60 SMD/m
Type LED	SMD 5050	Material	Flex PCB
Power/Meter	14.4W/m	Beam Angle	120°
Voltage	DC: 12V	IP Rating	IP20 ; IP54
Flux/Meter	1000lm/m	Width	10mm

SKU: 4312	RGB	3800156643123	IP20
SKU: 4316	RGB	3800156643161	IP54



LED Strip 12V 5050 60 LEDs
14.4W/m - Waterproof



Product code	ST5050-A2	LED Qty	60 SMD/m
Type LED	SMD 5050	Material	Flex PCB
Power/Meter	14.4W/m	Beam Angle	120°
Voltage	DC: 12V	IP Rating	IP54
Flux/Meter	1000lm/m	Width	10mm

SKU: 4842	BLUE	3800156648425
SKU: 4843	RED	3800156648432



LED Strip 24V 5050 60 LEDs
14.4W/m



Product code	ST5050-A1	LED Qty	60 SMD/m
Type LED	SMD 5050	Material	Flex PCB
Power/Meter	14.4W/m	Beam Angle	120°
Voltage	DC: 24V	IP Rating	IP20 ; IP54
Flux/Meter	1000lm/m	Width	10mm

SKU: 4861	RGB	3800156648616	IP20
SKU: 4862	RGB	3800156648623	IP54



LED Strip 12V 4040 60 LEDs
8.5W/m - Non Waterproof



Product code	ST4040-A1	LED Qty	60 SMD/m
Type LED	SMD 4040	Material	Flex PCB
Power/Meter	8.5W/m	Beam Angle	120°
Voltage	DC: 12V	IP Rating	IP20
Flux/Meter	500lm/m	Width	10mm

SKU: 4921	White Light	6000K	3800156649217
SKU: 4922	Neutral White	4500K	3800156649224
SKU: 4923	Warm White	2700K	3800156649231



LED Strip 24V 2835 120 LEDs
9.6W/m - Non Waterproof



Product code	ST2835-A3	LED Qty	120 SMD/m
Type LED	SMD 2835	Material	Flex PCB
Power/Meter	9.6W/m	Beam Angle	120°
Voltage	DC: 24V	IP Rating	IP20
Flux/Meter	1200lm/m	Width	10mm

SKU: 4856	White Light	6000K	3800156648562
SKU: 4857	Neutral White	4500K	3800156648579
SKU: 4858	Warm White	2700K	3800156648586



LED Strip 12V 4014 120 LEDs
12W/m - Non Waterproof



Product code	ST4014-A1	LED Qty	120 SMD/m
Type LED	SMD 4014	Material	Flex PCB
Power/Meter	12W/m	Beam Angle	120°
Voltage	DC: 12V	IP Rating	IP20
Flux/Meter	1000lm/m	Width	8mm

SKU: 4904	White Light	6000K	3800156649040
SKU: 4905	Neutral White	4500K	3800156649057
SKU: 4906	Warm White	2700K	3800156649064



LED Strip 24V 5050 60 LEDs
14.4W/m - Non Waterproof



Product code	ST5050-A3	LED Qty	60 SMD/m
Type LED	SMD 5050	Material	Flex PCB
Power/Meter	14.4W/m	Beam Angle	120°
Voltage	DC: 24V	IP Rating	IP20
Flux/Meter	600lm/m	Width	10mm

SKU: 4851	White Light	6000K	3800156648517
SKU: 4850	Neutral White	4500K	3800156648500
SKU: 4852	Warm White	2700K	3800156648524



LED Strip 12V 5630 60 LEDs
12W/m - Non Waterproof



Product code	ST5630-A1	LED Qty	60 SMD/m
Type LED	SMD 5630	Material	Flex PCB
Power/Meter	12W/m	Beam Angle	120°
Voltage	DC: 12V	IP Rating	IP20
Flux/Meter	1000lm/m	Width	10mm

SKU: 4911	White Light	6000K	3800156649118
SKU: 4913	Neutral White	4500K	3800156649132
SKU: 4912	Warm White	2700K	3800156649125



LED Strip 24V 5050 60 LEDs
14.4W/m - Waterproof



Product code	ST5050-A4	LED Qty	60 SMD/m
Type LED	SMD 5050	Material	Flex PCB
Power/Meter	14.4W/m	Beam Angle	120°
Voltage	DC: 24V	IP Rating	IP54
Flux/Meter	600lm/m	Width	10mm

SKU: 4853	White Light	6000K	3800156648531
SKU: 4854	Neutral White	4500K	3800156648548
SKU: 4855	Warm White	2700K	3800156648555



NEW

CRI 90+

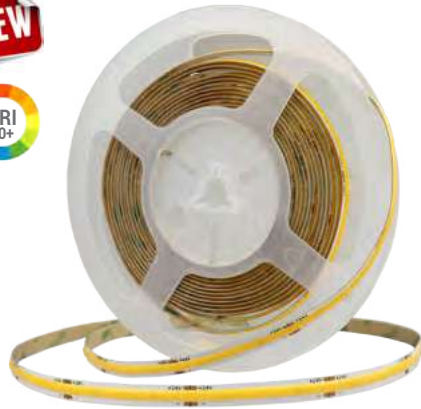

**LED Strip 24V COB 320 LEDs
10W/m - Non Waterproof**

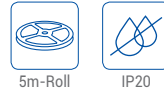

Product code	ST320-A1	LED Qty	320 SMD/m
Type LED	COB	Material	Flex PCB
Power/Meter	10W/m	Beam Angle	120°
Voltage	DC: 24V	IP Rating	IP20
Flux/Meter	900lm/m	Width	10mm

SKU: 4941	White Light	6000K	3800156649415
SKU: 4942	Neutral White	4000K	3800156649422
SKU: 4943	Warm White	3000K	3800156649439

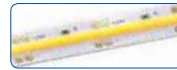

CRI 80+



**LED Strip 24V 2835 196 LEDs
20W/m - Non Waterproof**



Product code	ST2835-A4	LED Qty	196 SMD/m
Type LED	SMD 2835	Material	Flex PCB
Power/Meter	20W/m	Beam Angle	120°
Voltage	DC: 24V	IP Rating	IP20
Flux/Meter	2100lm/m	Width	12mm

SKU: 4421	White Light	6000K	3800156644212
SKU: 4422	Neutral White	4500K	3800156644229
SKU: 4423	Warm White	2700K	3800156644236



NEW

CRI 90+



**LED Strip 24V COB 512 LEDs
12W/m - Non Waterproof**

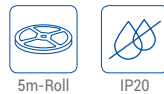

Product code	ST512-A1	LED Qty	512 SMD/m
Type LED	COB	Material	Flex PCB
Power/Meter	10W/m	Beam Angle	120°
Voltage	DC: 24V	IP Rating	IP20
Flux/Meter	1100lm/m	Width	10mm

SKU: 4944	White Light	6000K	3800156649446
SKU: 4945	Neutral White	4000K	3800156649453
SKU: 4946	Warm White	3000K	3800156649460



CRI 80+



**LED Strip 24V 2835 196 LEDs
20W/m - Waterproof**



Product code	ST2835-A5	LED Qty	196 SMD/m
Type LED	SMD 2835	Material	Flex PCB
Power/Meter	20W/m	Beam Angle	120°
Voltage	DC: 24V	IP Rating	IP65
Flux/Meter	2100lm/m	Width	12mm

SKU: 4451	White Light	6000K	3800156644519
SKU: 4452	Neutral White	4500K	3800156644526
SKU: 4453	Warm White	2700K	3800156644533



Middel connector

SKU: 6622 3800156666221



One end connector with wire

SKU: 6623 3800156666238



Two end connector

SKU: 6624 3800156666245



CRI 80+



**LED Strip 24V 5054 60 LEDs
16W/m - Non Waterproof**



Product code	ST5054-A1	LED Qty	60 SMD/m
Type LED	SMD 5054	Material	Flex PCB
Power/Meter	16W/m	Beam Angle	120°
Voltage	DC: 24V	IP Rating	IP20
Flux/Meter	1100lm/m	Width	12mm

SKU: 4431	White Light	6000K	3800156644311
SKU: 4432	Neutral White	4200K	3800156644328
SKU: 4433	Warm White	2700K	3800156644335





**LED Strip 24V 5054 60 LEDs
16W/m - Waterproof**



Product code	ST5054-A2	LED Qty	60 SMD/m
Type LED	SMD 5054	Material	Flex PCB
Power/Meter	16W/m	Beam Angle	120°
Voltage	DC: 24V	IP Rating	IP65
Flux/Meter	1100lm/m	Width	10mm

SKU: 4461	White Light	6000K	3800156644618
SKU: 4462	Neutral White	4200K	3800156644625
SKU: 4463	Warm White	2700K	3800156644632



**LED Strip 12V 2835 196 LEDs
20W/m - Non Waterproof**



Product code	ST2835-A5	LED Qty	196 SMD/m
Type LED	SMD 2835	Material	Flex PCB
Power/Meter	20W/m	Beam Angle	120°
Voltage	DC: 12V	IP Rating	IP20
Flux/Meter	2100lm/m	Width	12mm

SKU: 4424	White Light	6000K	3800156644243
SKU: 4425	Neutral White	4200K	3800156644250
SKU: 4426	Warm White	2700K	3800156644267



**LED Strip 24V 5025 60 LEDs
16W/m - CCT Adjustable
Non Waterproof**



Product code	ST5025-A1	LED Qty	60 SMD/m
Type LED	SMD 5025	Material	Flex PCB
Power/Meter	16W/m	Beam Angle	120°
Voltage	DC: 24V	IP Rating	IP20
Flux/Meter	800lm/m	Width	10mm

CCT

SKU: 4441	6000K	4000K	3000K	3800156644410
-----------	-------	-------	-------	---------------



**LED Strip 12V 2835 196 LEDs
20W/m - Waterproof**



Product code	ST2835-A6	LED Qty	196 SMD/m
Type LED	SMD 2835	Material	Flex PCB
Power/Meter	20W/m	Beam Angle	120°
Voltage	DC: 12V	IP Rating	IP65
Flux/Meter	2100lm/m	Width	12mm

SKU: 4454	White Light	6000K	3800156644540
SKU: 4455	Neutral White	4200K	3800156644557
SKU: 4456	Warm White	2800K	3800156644564



**LED Strip 24V 5025 60 LEDs
16W/m - CCT Adjustable
Waterproof**



Product code	ST5025-A2	LED Qty	60 SMD/m
Type LED	SMD 5025	Material	Flex PCB
Power/Meter	16W/m	Beam Angle	120°
Voltage	DC: 24V	IP Rating	IP65
Flux/Meter	800lm/m	Width	10mm

CCT

SKU: 4471	6000K	4000K	3000K	3800156644717
-----------	-------	-------	-------	---------------





**LED Strip 12V 5050 60 LEDs
16W/m - Non Waterproof**

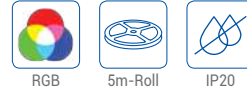

Product code	ST5050-A7	LED Qty	60 SMD/m
Type LED	SMD 5050	Material	Flex PCB
Power/Meter	16W/m	Beam Angle	120°
Voltage	DC: 12V	IP Rating	IP20
Flux/Meter	1600lm/m	Width	12mm



SKU: 4485 RGB+White Light + 3800156644854

SKU: 4486 RGB+Warm White + 3800156644861



**LED Strip 24V 5050 60 LEDs
16W/m - Non Waterproof**



Product code	ST5050-A5	LED Qty	60 SMD/m
Type LED	SMD 5050	Material	Flex PCB
Power/Meter	16W/m	Beam Angle	120°
Voltage	DC: 24V	IP Rating	IP20
Flux/Meter	1600lm/m	Width	10mm



SKU: 4481 RGB+White Light + 3800156644816

SKU: 4482 RGB+Warm White + 3800156644823



**LED Strip 24V 5050 60 LEDs
16W/m Waterproof**



Product code	ST5050-A6	LED Qty	60 SMD/m
Type LED	SMD 5050	Material	Flex PCB
Power/Meter	16W/m	Beam Angle	120°
Voltage	DC: 24V	IP Rating	IP65
Flux/Meter	1600lm/m	Width	10mm



SKU: 4483 RGB+White Light + 3800156644830

SKU: 4484 RGB+Warm White + 3800156644847



**LED Strip 12V 5050 60 LEDs
16W/m - Waterproof**

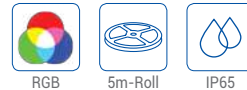

Product code	ST5050-A8	LED Qty	60 SMD/m
Type LED	SMD 5050	Material	Flex PCB
Power/Meter	16W/m	Beam Angle	120°
Voltage	DC: 12V	IP Rating	IP65
Flux/Meter	1600lm/m	Width	12mm



SKU: 4487 RGB+White Light + 3800156644878

SKU: 4488 RGB+Warm White + 3800156644885



**LED Strip 24V 5050 60 LEDs
9.5W/m - Non Waterproof**



Product code	ST5050-A9	LED Qty	60 SMD/m
Type LED	SMD 5050	Material	Flex PCB
Power/Meter	9.5W/m	Beam Angle	120°
Voltage	DC: 24V	IP Rating	IP20
Flux/Meter	950lm/m	Width	10mm



SKU: 4480 + CCT 3800156644809



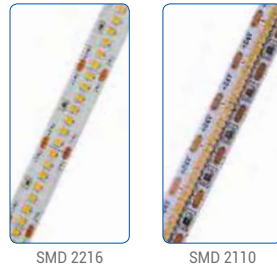

SMD 2216 SMD 2110



LED Strip 24V HIGH POWER
SMD2216 ; SMD2110

		Product code ST2216-A1 Type LED SMD 2216 Power/Meter 22W/m Voltage DC: 24V Flux/Meter 1900lm/m	LED Qty 240 SMD/m Material Flex PCB Beam Angle 120° IP Rating IP20 Width 10mm				SKU: 4403 Warm White ■ 3000K 3800156644038
		Product code ST2216-A1 Type LED SMD 2216 Power/Meter 24W/m Voltage DC: 24V Flux/Meter 2200lm/m	LED Qty 300 SMD/m Material Flex PCB Beam Angle 120° IP Rating IP20 Width 10mm				SKU: 4404 Warm White ■ 3000K 3800156644045
		Product code ST2110-A1 Type LED SMD 2110 Power/Meter 32W/m Voltage DC: 24V Flux/Meter 2500lm/m	LED Qty 560 SMD/m Material Flex PCB Beam Angle 120° IP Rating IP20 Width 12mm				SKU: 4405 Warm White ■ 3000K 3800156644052
		Product code ST2110-A1 Type LED SMD 2110 Power/Meter 38W/m Voltage DC: 24V Flux/Meter 3400lm/m	LED Qty 700 SMD/m Material Flex PCB Beam Angle 120° IP Rating IP20 Width 12mm				SKU: 4406 Warm White ■ 3000K 3800156644069



LED Digital Strip
Addressable

Product code ST10-A1 Type LED WS2811 10 Pixels Power/Meter 7W/m Voltage DC: 12V Flux/Meter 550lm/m LED Qty 30 SMD/m Material Flex PCB Beam Angle 120° IP Rating IP20 Width 10mm EAN Code 3800156644908	SKU: 4490	Product code ST30-A1 Type LED WS2812b 30 Pixels Power/Meter 8W/m Voltage DC: 5V Flux/Meter 600lm/m LED Qty 30 SMD/m Material Flex PCB Beam Angle 120° IP Rating IP20 Width 10mm EAN Code 3800156644915	SKU: 4491	Product code ST60-A1 Type LED WS2812b 30 Pixels Power/Meter 16W/m Voltage DC: 5V Flux/Meter 1200lm/m LED Qty 60 SMD/m Material Flex PCB Beam Angle 120° IP Rating IP20 Width 10mm EAN Code 3800156644922	SKU: 4492	
-------------------------------------------------------------------------------------------------------------------------------------------------------------------------------------------------------------------------------------------------------------------------------------------------------------------	------------------	-------------------------------------------------------------------------------------------------------------------------------------------------------------------------------------------------------------------------------------------------------------------------------------------------------------------	------------------	---------------------------------------------------------------------------------------------------------------------------------------------------------------------------------------------------------------------------------------------------------------------------------------------------------------------	------------------	--

Digital LED Strip Controller
DC5-24V SD-CARD



Voltage 5V-24V
IP Rating IP20
Dimension 80x55x20mm
SKU: 6331

Digital LED Strip Controller
DC5-24V



Voltage 5V-24V
IP Rating IP20
Dimension 80x55x20mm
SKU: 6332

**LED Strip 12V 5050 30 LEDs - SET
Adapter + ir Controller + Remote**

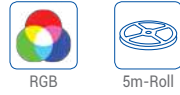

Product code	ST5050-B1	LED Qty	30 SMD/m
Type LED	SMD 5050	Material	Flex PCB
Power/Meter	4W/m	Beam Angle	120°
Voltage	DC: 12V	IP Rating	IP20
Flux/Meter	240lm/m	Width	10mm

SET SKU: 4321 RGB 3800156643215 IP20



**LED Strip 12V 5050 30 LEDs - SET
Adapter + Bluetooth Music + Remote**

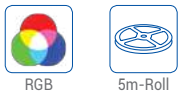

Product code	ST5050-B1	LED Qty	30 SMD/m
Type LED	SMD 5050	Material	Flex PCB
Power/Meter	4W/m	Beam Angle	120°
Voltage	DC: 12V	IP Rating	IP20
Flux/Meter	240lm/m	Width	10mm

SET SKU: 4328 RGB 3800156643284 IP20 Music



**LED Strip 12V 5050 60 LEDs - SET
Adapter + ir Controller + Remote**

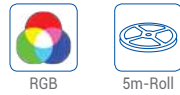

Product code	ST5050-B1	LED Qty	60 SMD/m
Type LED	SMD 5050	Material	Flex PCB
Power/Meter	8W/m	Beam Angle	120°
Voltage	DC: 12V	IP Rating	IP20
Flux/Meter	480lm/m	Width	10mm

SET SKU: 4322 RGB 3800156643222 IP20



**LED Strip 12V 5050 60 LEDs - SET
Adapter + Bluetooth Music + Remote**

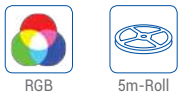

Product code	ST5050-B1	LED Qty	60 SMD/m
Type LED	SMD 5050	Material	Flex PCB
Power/Meter	8W/m	Beam Angle	120°
Voltage	DC: 12V	IP Rating	IP20
Flux/Meter	480lm/m	Width	10mm

SET SKU: 4329 RGB 3800156643291 IP20 Music



**LED Strip 12V 5050 60 LEDs - SET
Adapter + ir Controller + Remote
Waterproof**

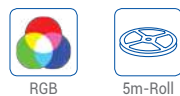

Product code	ST5050-B1	LED Qty	60 SMD/m
Type LED	SMD 5050	Material	Flex PCB
Power/Meter	8W/m	Beam Angle	120°
Voltage	DC: 12V	IP Rating	IP54
Flux/Meter	480lm/m	Width	10mm

SET SKU: 4323 RGB 3800156643239 IP54



**LED Strip 12V 5050 60 LEDs - SET
Adapter + Bluetooth Music + Remote
Waterproof**



Product code	ST5050-B1	LED Qty	60 SMD/m
Type LED	SMD 5050	Material	Flex PCB
Power/Meter	8W/m	Beam Angle	120°
Voltage	DC: 12V	IP Rating	IP54
Flux/Meter	480lm/m	Width	10mm

SET SKU: 4330 RGB 3800156643307 IP54 Music





**Smart LED Strip 12V 5050+2835 - SET
Adapter + Wifi Controller**

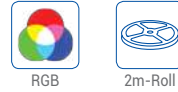

Product code	ST5050-B1	LED Qty	60 SMD/m
Type LED	SMD 5050+2835	Material	Flex PCB
Power/Meter	4W/m	Beam Angle	120°
Voltage	DC: 12V	IP Rating	IP20
Flux/Meter	240lm/m	Width	10mm

- SKU: 4324 RGB+W 3800156643246 IP20
- SKU: 4325 RGB+WW 3800156643253 IP20



**Smart LED Strip 12V CCT 5050+2835 -SET
Adapter + Wifi Controller**

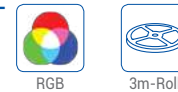

Product code	ST5050-B1	LED Qty	90 SMD/m
Type LED	SMD 5050+2835	Material	Flex PCB
Power/Meter	6W/m	Beam Angle	120°
Voltage	DC: 12V	IP Rating	IP54
Flux/Meter	360lm/m	Width	12mm

- SKU: 4326 RGB+CCT 3800156643260 IP20



**TV LED Strip 5V 5050+2835 60LEDs - SET
Wifi Controller + Remote**



Product code	ST5050-B1	LED Qty	60 SMD/m
Type LED	SMD 5050+2835	Material	Flex PCB
Power/Meter	4W/m	Beam Angle	120°
Voltage	DC: 5V	IP Rating	IP20
Flux/Meter	240lm/m	Width	10mm

- SKU: 4327 RGB+WW 3800156643277 IP20

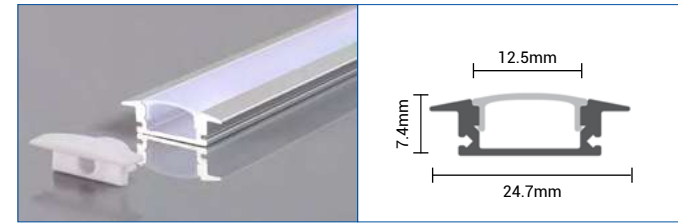

- SKU: 5104 Black Body- White Cover (L=2m) 3800156651043
- SKU: 5105 Black Body- Black Cover (L=2m) 3800156651050
- SKU: 5106 White Body- White Cover (L=2m) 3800156651067

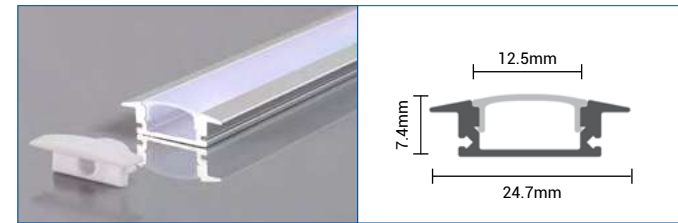

- SKU: 5193 Silver Body- White Cover (L=1m) 3800156651937
- SKU: 5192 Silver Body- White Cover (L=2m) 3800156651920

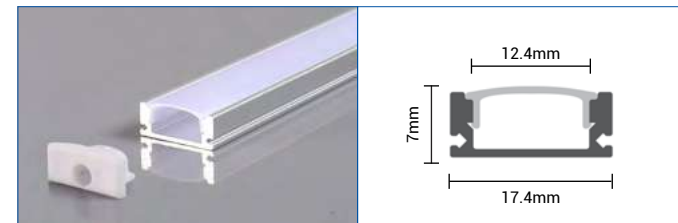

- SKU: 5190 Silver Body- White Cover (L=1m) 3800156651906
- SKU: 5191 Silver Body- White Cover (L=2m) 3800156651913
- SKU: 5184 White Body- White Cover (L=2m) 3800156651845
- SKU: 5185 Black Body- White Cover (L=2m) 3800156651852

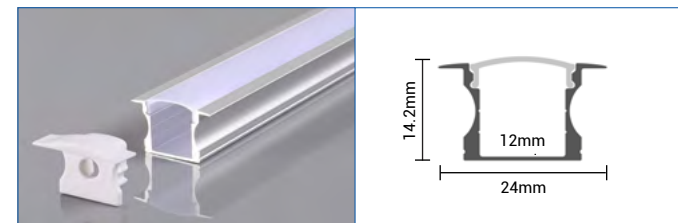

- SKU: 5108 Silver Body- White Cover (L=2m) 3800156651081

NEW

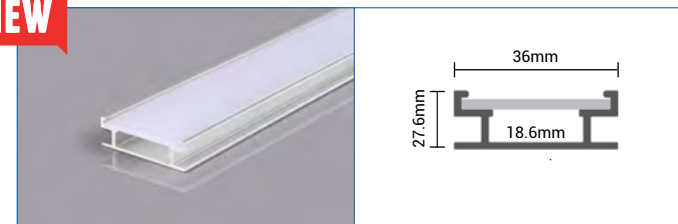

- SKU: 5113 Silver Body- White Cover (L=2m) 3800156651135

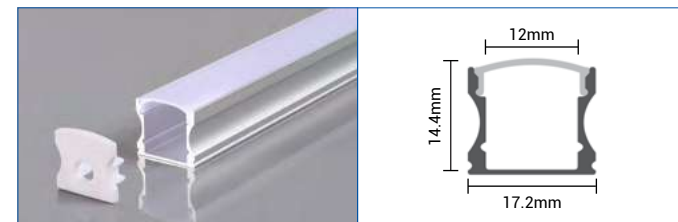

- SKU: 5175 Silver Body- White Cover (L=2m) 3800156651753

NEW

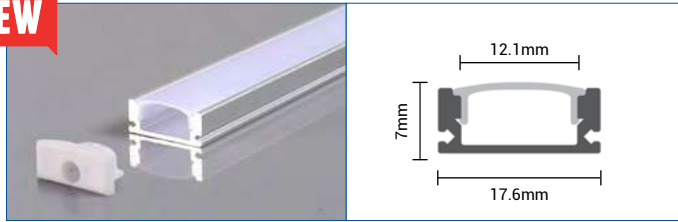

SKU: 5107 Black Body- Black Cover (L=2m) ■■
3800156651074

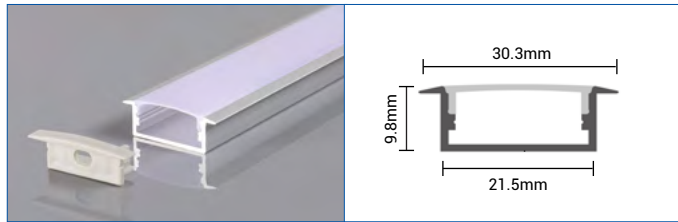

SKU: 5109 Silver Body- White Cover (L=2m) ■□
3800156651098



SKU: 5183 Silver Body- White Cover (L=2m) ■□
3800156651838



SKU: 5101 Black Body- Black Cover (L=2m) ■■
3800156651012

SKU: 5102 White Body- White Cover (L=2m) □□
3800156651029

SKU: 5103 Silver Body- White Cover (L=2m) ■□
3800156651036

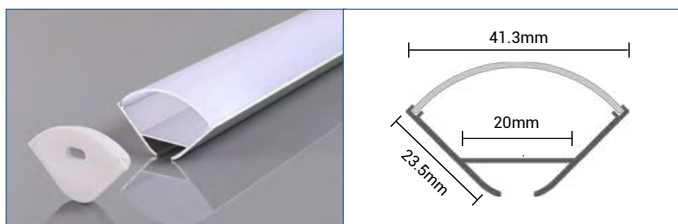

SKU: 5110 Silver Body- White Cover (L=2m) ■□
3800156651104

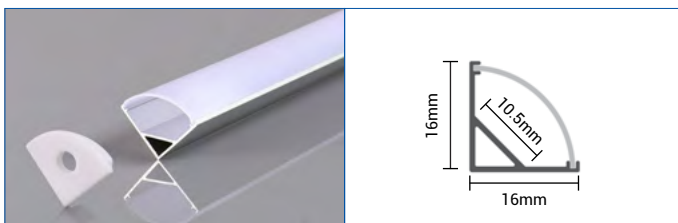

SKU: 5150 Silver Body- White Cover (L=2m) ■□
3800156651500

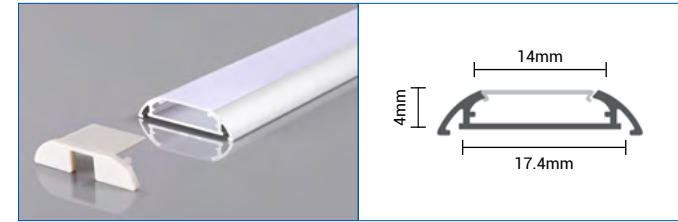

SKU: 5002 Bendable - Silver body (L=1m) ■
3800156650022

SKU: 5001 Bendable - Silver body (L=2m) ■
3800156650015

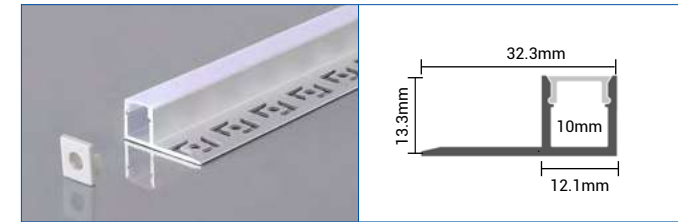

SKU: 5111 Silver Body- White Cover (L=2m) ■□
3800156651111

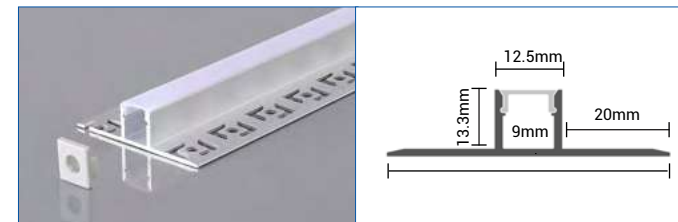

SKU: 5112 Silver Body- White Cover (L=2m) ■□
3800156651128

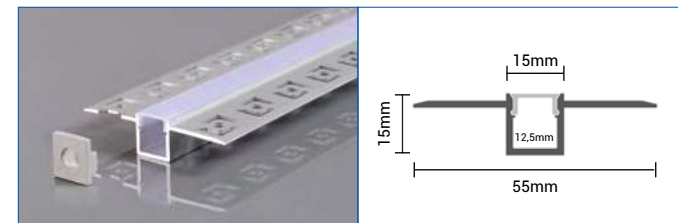

SKU: 5162 Silver Body- White Cover (L=2m) ■□
3800156651623

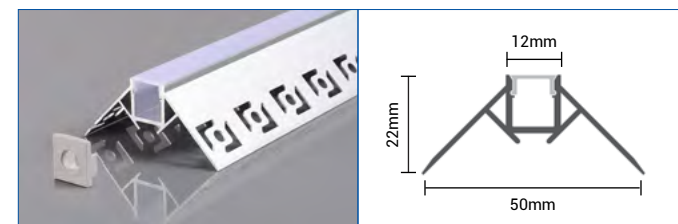

SKU: 5165 Silver Body- White Cover (L=2m) ■□
3800156651654

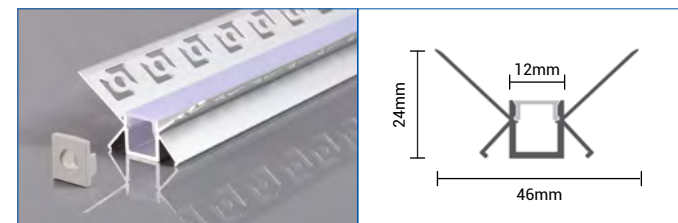

SKU: 5166 Silver Body- White Cover (L=2m) ■□
3800156651661

NEW

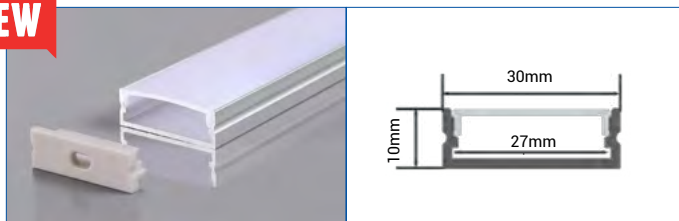

SKU: 5114 Black Body- Black Cover (L=2m) ■■
3800156651142

SKU: 5115 Silver Body- White Cover (L=2m) □□
3800156651159

SKU: 5116 Black Body- White Cover (L=2m) ■□
3800156651166

NEW

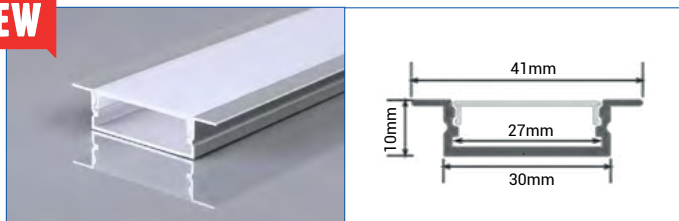

SKU: 5117 Black Body- Black Cover (L=2m) ■■
3800156651173

SKU: 5118 Silver Body- White Cover (L=2m) □□
3800156651180

SKU: 5119 Black Body- White Cover (L=2m) ■□
3800156651197

NEW

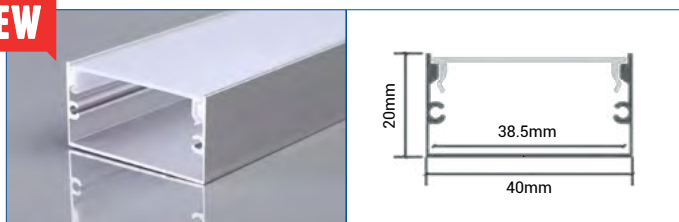

SKU: 5120 Black Body- Black Cover (L=2m) ■■
3800156651203

SKU: 5121 Silver Body- White Cover (L=2m) □□
3800156651210

SKU: 5122 Black Body- White Cover (L=2m) ■□
3800156651227

NEW

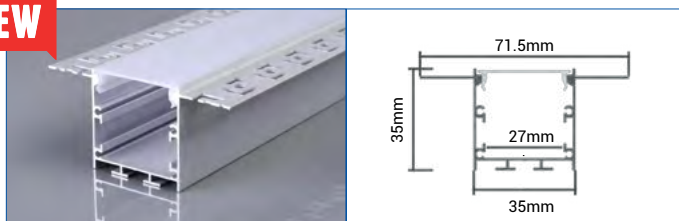

SKU: 5123 Black Body- Black Cover (L=2m) ■■
3800156651234

SKU: 5124 Silver Body- White Cover (L=2m) □□
3800156651241

SKU: 5125 Black Body- White Cover (L=2m) ■□
3800156651258



NEW

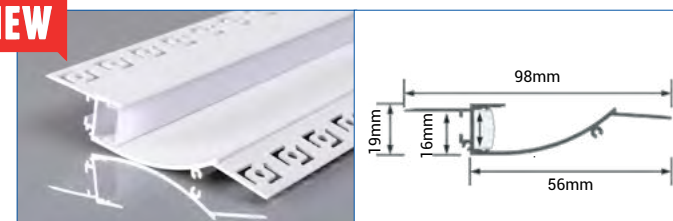

SKU: 5128 Silver Body- White Cover (L=2m) □□
3800156651289

NEW



SKU: 5130 Silver Body- White Cover (L=2m) □□
3800156651302

NEW



SKU: 5132 Silver Body- White Cover (L=2m) □□
3800156651326

NEW

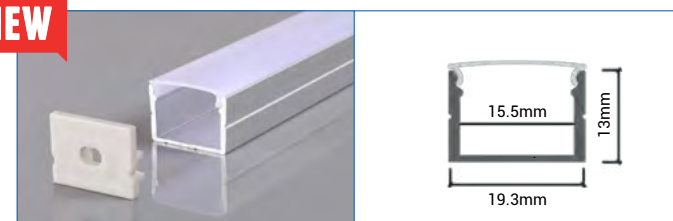

SKU: 5133 Silver Body- White Cover (L=2m) □□
3800156651333

NEW

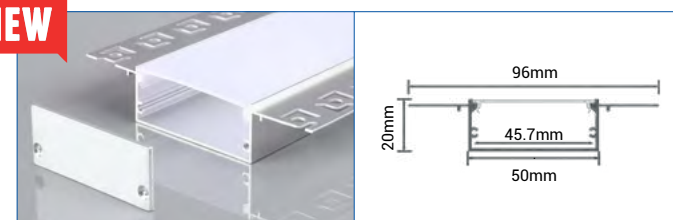

SKU: 5134 Silver Body- White Cover (L=2m) □□
3800156651340

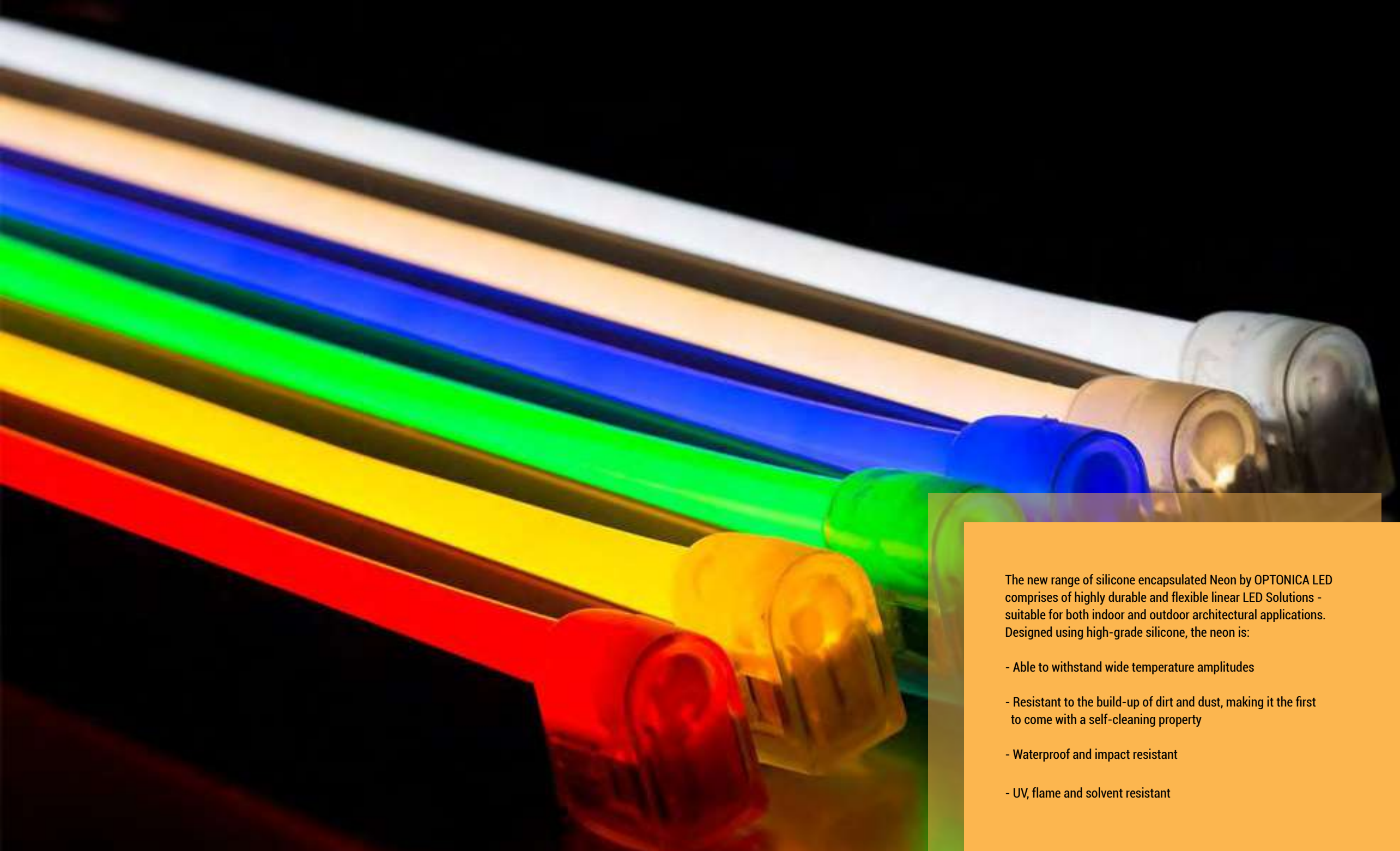

The new range of silicone encapsulated Neon by OPTONICA LED comprises of highly durable and flexible linear LED Solutions - suitable for both indoor and outdoor architectural applications. Designed using high-grade silicone, the neon is:

- Able to withstand wide temperature amplitudes
- Resistant to the build-up of dirt and dust, making it the first to come with a self-cleaning property
- Waterproof and impact resistant
- UV, flame and solvent resistant

LED STRIPS 220V AND FLEX NEON

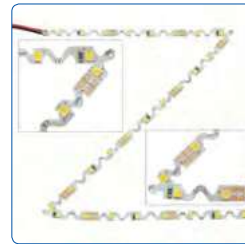

Free Angle Bending

LED Strip S-Type 12V 2835 60 LEDs
7.2W/m - Non Waterproof

Product code	M02835-A2	LED Qty	60 SMD/m
Type LED	SMD 2835	Material	Flex PCB
Power/Meter	7.2W/m	Beam Angle	120°
Voltage	DC: 12V	IP Rating	IP20
Flux/Meter	720lm/m	Width	6mm

SKU: 4541	White Light	6000K	3800156645417
SKU: 4546	Neutral White	4000K	3800156645462
SKU: 4542	Warm White	3000K	3800156645424

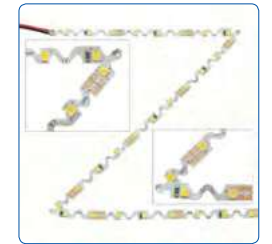

Free Angle Bending

LED Strip S-Type 12V 2835 60 LEDs
7.2W/m - Waterproof

Product code	M02835-A2	LED Qty	60 SMD/m
Type LED	SMD 2835	Material	Flex PCB
Power/Meter	7.2W/m	Beam Angle	120°
Voltage	DC: 12V	IP Rating	IP65
Flux/Meter	720lm/m	Width	6mm

SKU: 4551	White Light	6000K	3800156645516
SKU: 4552	Warm White	2700K	3800156645523

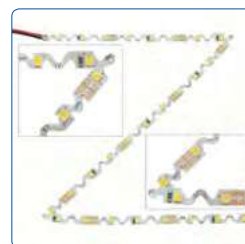

Free Angle Bending

LED Strip S-Type 12V 2835 60 LEDs
7.2W/m - Non Waterproof

Product code	M02835-A2	LED Qty	60 SMD/m
Type LED	SMD 2835	Material	Flex PCB
Power/Meter	7.2W/m	Beam Angle	120°
Voltage	DC: 12V	IP Rating	IP20
Flux/Meter	720lm/m	Width	6mm

SKU: 4543	RED	3800156645431
SKU: 4545	GREEN	3800156645455
SKU: 4544	BLUE	3800156645448

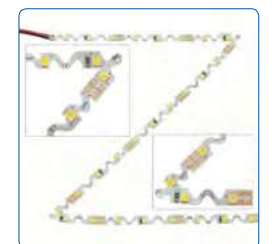

Free Angle Bending

LED Strip S-Type 12V 2835 60 LEDs
7.2W/m - Waterproof

Product code	M02835-A2	LED Qty	60 SMD/m
Type LED	SMD 2835	Material	Flex PCB
Power/Meter	7.2W/m	Beam Angle	120°
Voltage	DC: 12V	IP Rating	IP65
Flux/Meter	720lm/m	Width	6mm

SKU: 4553	RED	3800156645530
SKU: 4555	GREEN	3800156645554
SKU: 4554	BLUE	3800156645547

NEW



LED FLEX NEON 12V -50m Roll
2835 120 SMD/m

Product code	ST12-A2	LED Qty	120 SMD/m
Type LED	SMD 2835	Material	Flex PC
Power/Meter	6W/m	Beam Angle	120°
Voltage	DC: 12V	IP Rating	IP65
Flux/Meter	300lm/m	Dimension	16x8 mm

SKU: 4590	6000K	3800156645905
SKU: 4591	4000K	3800156645912
SKU: 4592	2800K	3800156645929
SKU: 4593	Blue	3800156645936
SKU: 4594	Red	3800156645943
SKU: 4595	Green	3800156645950
SKU: 4596	Ice Blue	3800156645967
SKU: 4597	Lemon	3800156645974
SKU: 4598	Golden	3800156645981
SKU: 4599	PURPLE	3800156645998

LED FLEX NEON 220V -50m Roll
2835 120 SMD/m

Product code	ST220-A2	LED Qty	120 SMD/m
Type LED	SMD 2835	Material	Flex PC
Power/Meter	8.5W/m	Beam Angle	120°
Voltage	AC: 220V	IP Rating	IP65
Flux/Meter	300lm/m	Dimension	Single 16x10 mm RGB 25x13 mm

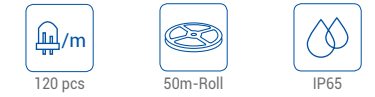

SKU: 4581	6000K	3800156645813
SKU: 4580	4000K	3800156645806
SKU: 4582	2800K	3800156645820
SKU: 4584	RED	3800156645844
SKU: 4585	GREEN	3800156645851
SKU: 4583	BLUE	3800156645837
SKU: 4587	YELLOW	3800156645875
SKU: 4586	AMBER	3800156645868
SKU: 4588	PINK	3800156645882
SKU: 4589	RGB	3800156645899

PLUG IN + CONNECTOR PIN



SKU: 6602

MOUNTING BRACKET



SKU: 6603

ALUMINIUM CLIPS



SKU: 6601

END CAP FOR



SKU: 6605

INPUT CABLE + CONNECTOR + PLUG



SKU: 6635

MIDDLE CONNECTOR



SKU: 6634

ALUMINIUM CHANNEL WITH 2 SCREWS



SKU: 6636

END CAP FOR SINGLE COLOUR



SKU: 6637

CONNECTOR PLUG



SKU: 6604



POWER CABLE+RGB CONTROLLER



SKU: 6638

ALUMINIUM CHANNEL , 5CM RGB



SKU: 6639

END CAP FOR RGB



SKU: 6640



LED Strips 220V -50m Roll
5730 120 SMD/m

Product code	ST220-A1	LED Qty	120 SMD/m
Type LED	SMD 5730	Material	Flex PC
Power/Meter	10W/m	Beam Angle	120°
Voltage	AC: 220V	IP Rating	IP65
Flux/Meter	500lm/m	Dimension	13x5 mm

SKU: 4611	White Light	6000K	3800156646117
SKU: 4613	Neutral White	4000K	3800156646131
SKU: 4612	Warm White	2800K	3800156646124

2835/5730 INPUT CABLE + CONNECTOR



SKU: 6631

2835/5730 MIDDLE CONNECTOR



SKU: 6633

2835/5730 FIXING



SKU: 6632

END CAP FOR 220V



SKU: 6637

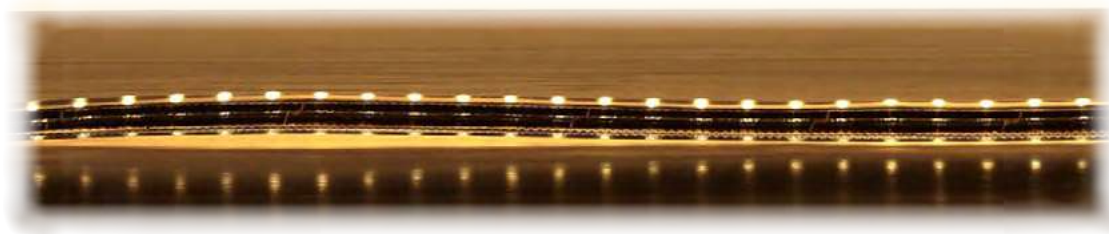



LENS LED Module 1.6W - 220V
3x2835 SMD - Waterproof



Product code	M0220-A1	LED Qty	3 pcs
Type LED	SMD 2835	Material	PC
Power/Module	1.2W	Beam Angle	160°
Voltage	AC: 220-265V	IP Rating	IP67
Flux/Watt	84lm/W	Dimension	88x22x11mm

SKU: 4564 White Light 6500K 3800156645646



LED Module 2.4W
4x2835 SMD - Waterproof



Product code	M02835-A1	LED Qty	4 pcs
Type LED	SMD 2835	Material	PC
Power/Module	2.4W	Beam Angle	160°
Voltage	DC: 12V	IP Rating	IP65
Flux/Watt	35lm/W	Dimension	43x38x6.5mm

SKU: 4561 White Light 6500K 3800156645615
SKU: 4562 Warm White 3000K 3800156645622



LENS LED Module 0.72W
3x2835 SMD - Waterproof



Product code	M02835-A1	LED Qty	3 pcs
Type LED	SMD 2835	Material	PC
Power/Module	0.72W	Beam Angle	160°
Voltage	DC: 12V	IP Rating	IP65
Flux/Watt	110lm/W	Dimension	58x12mm

SKU: 4512 White Light 10000K 3800156645127
SKU: 4511 White Light 6500K 3800156645110
SKU: 4513 Warm White 3000K 3800156645134
SKU: 4514 RED 3800156645141
SKU: 4516 GREEN 3800156645165
SKU: 4515 BLUE 3800156645158



LENS LED Module 0.72W
3x5050 SMD - Waterproof



Product code	M05050-A1	LED Qty	3 pcs
Type LED	SMD 5050	Material	PC
Power/Module	0.72W	Beam Angle	120°
Voltage	DC: 12V	IP Rating	IP65
Flux/Watt	118lm/W	Dimension	70x16x8mm

SKU: 4563 RGB 3800156645639

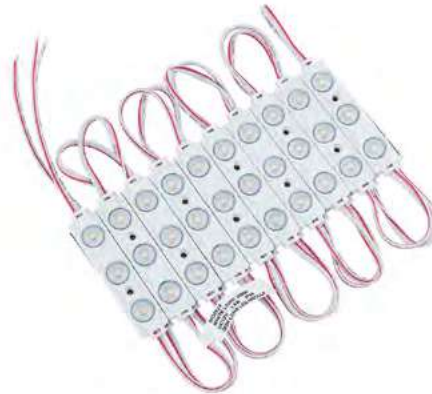

LENS LED Module 1.5W
3x2835 SMD - Waterproof



Product code	M02835-A1	LED Qty	3 pcs
Type LED	SMD 2835	Material	PC
Power/Module	1.5W	Beam Angle	160°
Voltage	DC: 12V	IP Rating	IP65
Flux/Watt	80lm/W	Dimension	75x15mm

SKU: 4522 White Light 10000K 3800156645226
SKU: 4521 White Light 6500K 3800156645219
SKU: 4523 Warm White 3000K 3800156645233
SKU: 4524 RED 3800156645240
SKU: 4526 GREEN 3800156645264
SKU: 4525 BLUE 3800156645257



LED Module 0.36W
3x3014 SMD - Waterproof



Product code	M03014-A1	LED Qty	3 pcs
Type LED	SMD 3014	Material	PC
Power/Module	0.36W	Beam Angle	120°
Voltage	DC: 12V	IP Rating	IP65
Flux/Watt	85lm/W	Dimension	18x8x2.9mm

SKU: 4531 White Light 6500K 3800156645318
SKU: 4532 Warm White 3000K 3800156645325
SKU: 4533 RED 3800156645332
SKU: 4535 GREEN 3800156645356
SKU: 4534 BLUE 3800156645349





Our portfolio covers best-performing all world-wide LVD power standards including narrow-body for installation ease in tricky spaces. Cost-efficient on your utility bills and your maintenance budget.

Features:

- 5V, 12V and 24V units come in a choice of sizes and shapes
- Specialized dimmable products for panels and downlights
- Waterproof options available with various degree of ingress-protection ratings
- Extended life cycle through forced heat dissipation, making them utmost reliable

Application:

- The natural choice for each LED strip design and installation
- A vital part of any lighting application

LED POWER SUPPLIES

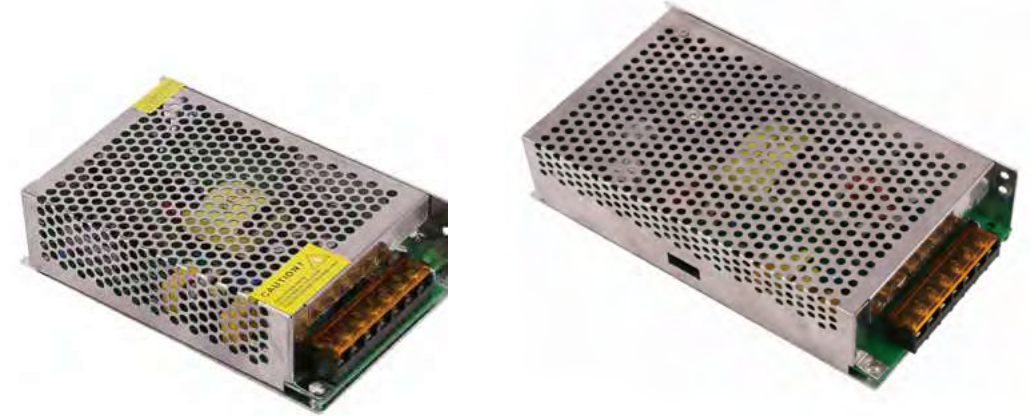

**TRIAC Dimmable Power Supplies
Metal 12V Output**



SKU: 6271 AC75-A1 75W - 12V 3800156662711
 SKU: 6272 AC100-A5 100W - 12V 3800156662728
 SKU: 6273 AC150-A5 150W - 12V 3800156662735

Watts	75W	100W	150W
Input Voltage	220-240V	220-240V	220-240V
Output Voltage	DC: 12V	DC: 12V	DC: 12V
Current	6.25A	8.33A	12.5A
Material	Metal	Metal	Metal
IP Rating	IP20	IP20	IP20
Dimension	190x50x31mm	206x67x37mm	206x67x37mm

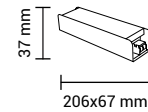
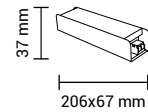
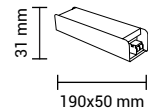

**Power Supplies for Track Light
Metal 48V Output**



SKU: 6284 AC120-B1 120W - 48V 3800156662841
 SKU: 6285 AC250-B1 250W - 48V 3800156662858

Watts	120W	250W
Input Voltage	220V	220V
Output Voltage	DC: 48V	DC: 48V
Current	2.5A	5.2A
Material	Metal	Metal
IP Rating	IP20	IP20
Dimension	190x90x30mm	220x120x30mm

**TRIAC Dimmable Power Supplies
Metal 24V Output**



SKU: 6281 AC75-A2 75W - 24V 3800156662810
 SKU: 6282 AC100-A6 100W - 24V 3800156662827
 SKU: 6283 AC150-A6 150W - 24V 3800156662834

Watts	75W	100W	150W
Input Voltage	220-240V	220-240V	220-240V
Output Voltage	DC: 24V	DC: 24V	DC: 24V
Current	3.1A	4.17A	6.25A
Material	Metal	Metal	Metal
IP Rating	IP20	IP20	IP20
Dimension	119x52x32mm	206x67x37mm	206x67x37mm

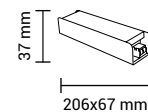
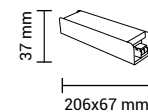
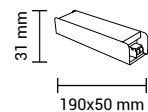



Strip Power Supplies Premium Plastic 12V Output



SKU: 6201	AC36-A1	36W - 12V	3800156662018
SKU: 6202	AC60-A1	60W - 12V	3800156662025
SKU: 6203	AC72-A1	72W - 12V	3800156662032

Watts	36W	60W	72W
Input Voltage	100-240V	100-240V	100-240V
Output Voltage	DC: 12V	DC: 12V	DC: 12V
Current	3A	5A	6A
Material	Plastic	Plastic	Plastic
IP Rating	IP20	IP20	IP20
Dimension	119x52x32mm	119x52x32mm	119x52x32mm

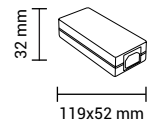
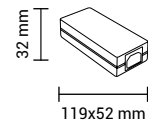
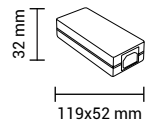

Strip Power Supplies Premium SLIM - Metal 12V Output



SKU: 6211	AC60-A3	60W - 12V	3800156662117
SKU: 6212	AC100-A3	100W - 12V	3800156662124
SKU: 6213	AC150-A3	150W - 12V	3800156662131
SKU: 6214	AC200-A3	200W - 12V	3800156662148

Watts	60W	100W	150W	200W
Input Voltage	100-240V	100-240V	176-265V	176-265V
Output Voltage	DC: 12V	DC: 12V	DC: 12V	DC: 12V
Current	5A	8.4A	12.5A	16.7A
Material	Metal	Metal	Metal	Metal
IP Rating	IP20	IP20	IP20	IP20
Dimension	130x50x31mm	190x50x31mm	200x62x31mm	208x82x32mm

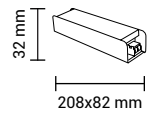
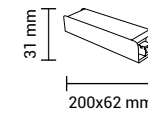
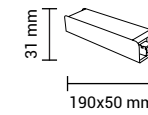
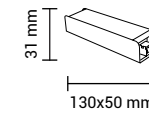

Strip Power Supplies Premium Plastic 24V Output



SKU: 6206	AC36-A2	36W - 24V	3800156662063
SKU: 6207	AC60-A2	60W - 24V	3800156662070
SKU: 6208	AC72-A2	72W - 24V	3800156662087

Watts	36W	60W	72W
Input Voltage	100-240V	100-240V	100-240V
Output Voltage	DC: 24V	DC: 24V	DC: 24V
Current	1.5A	2.5A	3A
Material	Plastic	Plastic	Plastic
IP Rating	IP20	IP20	IP20
Dimension	119x52x32mm	119x52x32mm	119x52x32mm

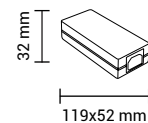
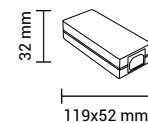
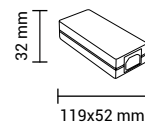

Strip Power Supplies Premium SLIM - Metal 24V Output



SKU: 6221	AC60-A4	60W - 24V	3800156662216
SKU: 6222	AC100-A4	100W - 24V	3800156662223
SKU: 6223	AC150-A4	150W - 24V	3800156662230
SKU: 6224	AC200-A4	200W - 24V	3800156662247

Watts	60W	100W	150W	200W
Input Voltage	100-240V	100-240V	176-265V	176-265V
Output Voltage	DC: 24V	DC: 24V	DC: 24V	DC: 24V
Current	2.5A	4.2A	6.25A	8.35A
Material	Metal	Metal	Metal	Metal
IP Rating	IP20	IP20	IP20	IP20
Dimension	130x50x31mm	190x50x31mm	200x60x31mm	208x82x32mm

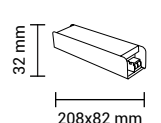
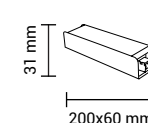
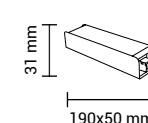
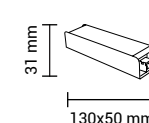



Strip Power Supplies Premium Plastic Case 12V Output



SKU: 6231	AC24-A5	24W - 12V	3800156662315
SKU: 6232	AC36-A5	36W - 12V	3800156662322
SKU: 6233	AC60-A5	60W - 12V	3800156662339

Watts	24W	36W	60W
Input Voltage	100-240V	100-240V	100-240V
Output Voltage	DC: 12V	DC: 12V	DC: 12V
Current	2A	3A	5A
Material	Plastic	Plastic	Plastic
IP Rating	IP20	IP20	IP20
Dimension	120x42x28mm	140x48x30mm	155x53x30mm

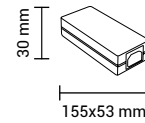
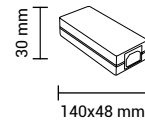
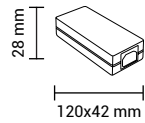

Strip Power Supplies Premium Plastic Case 24V Output



SKU: 6241	AC24-A6	24W - 24V	3800156662414
SKU: 6242	AC36-A6	36W - 24V	3800156662421
SKU: 6243	AC60-A6	60W - 24V	3800156662438

Watts	24W	36W	60W
Input Voltage	100-240V	100-240V	100-240V
Output Voltage	DC: 24V	DC: 24V	DC: 24V
Current	1A	1.5A	2.5A
Material	Plastic	Plastic	Plastic
IP Rating	IP20	IP20	IP20
Dimension	120x42x28mm	140x48x30mm	155x53x30mm

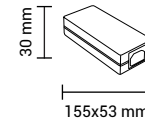
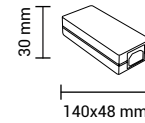
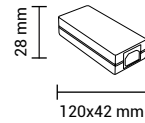

Strip Power Supplies Premium Waterproof 12V Output



SKU: 6251	AC600-A7	60W - 12V	3800156662513
SKU: 6252	AC100-A7	100W - 12V	3800156662520
SKU: 6253	AC150-A7	150W - 12V	3800156662537
SKU: 6254	AC200-A7	200W - 12V	3800156662544

Watts	60W	100W	150W	200W
Input Voltage	100-240V	100-240V	176-265V	176-265V
Output Voltage	DC: 12V	DC: 12V	DC: 12V	DC: 12V
Current	5A	8.4A	12.5A	16.7A
Material	Metal	Metal	Metal	Metal
IP Rating	IP67	IP67	IP67	IP67
Dimension	158x52x32mm	220x52x32mm	233x65x32mm	244x80x32mm

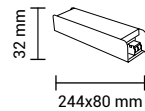
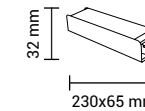
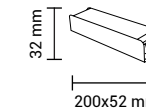
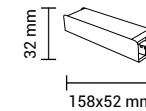

Strip Power Supplies Premium Waterproof 24V Output



SKU: 6261	AC60-A8	60W - 24V	3800156662612
SKU: 6262	AC100-A8	100W - 24V	3800156662629
SKU: 6263	AC150-A8	150W - 24V	3800156662636
SKU: 6264	AC200-A8	200W - 24V	3800156662643

Watts	60W	100W	150W	200W
Input Voltage	100-240V	100-240V	176-265V	176-265V
Output Voltage	DC: 24V	DC: 24V	DC: 24V	DC: 24V
Current	2.5A	4.2A	6.25A	8.35A
Material	Metal	Metal	Metal	Metal
IP Rating	IP67	IP67	IP67	IP67
Dimension	158x52x32mm	220x52x32mm	230x65x32mm	244x80x32mm

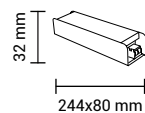
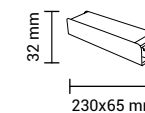
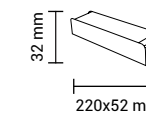
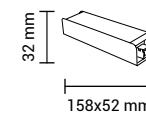



Strip Power Supplies
Plastic 12V Output



- SKU: 6120 18W - 12V 3800156661202
- SKU: 6101 24W - 12V 3800156661011
- SKU: 6102 36W - 12V 3800156661028
- SKU: 6103 60W - 12V 3800156661035
- SKU: 6119 80W - 12V 3800156661196

18W

Product Code	AC18-A1	Current	1,5A
Watts	18W	Material	Plastic
Input Voltage	220-240V	IP Rating	IP20
Output Voltage	DC: 12V	Dimension	85x50x34mm

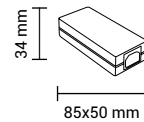

24W

Product Code	AC24-A1	Current	2A
Watts	24W	Material	Plastic
Input Voltage	220-240V	IP Rating	IP20
Output Voltage	DC: 12V	Dimension	90x50x31mm

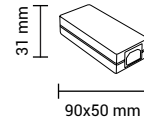

36W

Product Code	AC36-A1	Current	3A
Watts	36W	Material	Plastic
Input Voltage	220-240V	IP Rating	IP20
Output Voltage	DC: 12V	Dimension	124x58x32mm

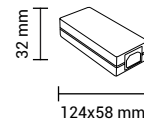

60W

Product Code	AC60-A1	Current	5A
Watts	60W	Material	Plastic
Input Voltage	220-240V	IP Rating	IP20
Output Voltage	DC: 12V	Dimension	124x58x32mm

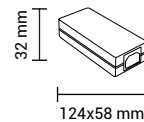

80W

Product Code	AC80-A1	Current	6.5A
Watts	80W	Material	Plastic
Input Voltage	220-240V	IP Rating	IP20
Output Voltage	DC:12V	Dimension	136x64x40mm

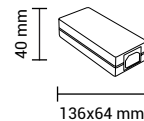

Strip Power Supplies
Waterproof Metal 12V Output



- SKU: 6110 30W - 12V 3800156661103
- SKU: 6111 60W - 12V 3800156661110
- SKU: 6115 100W - 12V 3800156661158
- SKU: 6112 150W - 12V 3800156661127

30W

Product Code	AC30-A7	Current	2.5A
Watts	30W	Material	Aluminium
Input Voltage	220V	IP Rating	IP67
Output Voltage	DC: 12V	Dimension	221x30x34mm

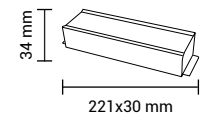

60W

Product Code	AC60-A7	Current	5A
Watts	60W	Material	Aluminium
Input Voltage	220V	IP Rating	IP67
Output Voltage	DC: 12V	Dimension	174x67x43mm

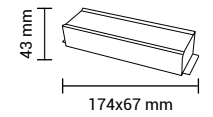

100W

Product Code	AC100-A7	Current	8.5A
Watts	100W	Material	Aluminium
Input Voltage	220V	IP Rating	IP67
Output Voltage	DC: 12V	Dimension	237x70x43mm

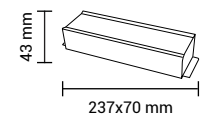

150W

Product Code	AC150-A7	Current	12.5A
Watts	150W	Material	Aluminium
Input Voltage	220V	IP Rating	IP67
Output Voltage	DC:12V	Dimension	235x50x85mm

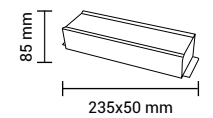



Strip Power Supplies
Metal 12V Output



SKU: 6104	AC24-A3	24W - 12V	3800156661042
SKU: 6121	AC36-A3	36W - 12V	3800156661219
SKU: 6105	AC60-A3	60W - 12V	3800156661059
SKU: 6109	AC100-A3	100W - 12V	3800156661097
SKU: 6106	AC120-A3	120W - 12V	3800156661066

Watts	24W	36W	60W	100W	120W
Input Voltage	220V	220V	220V	220V	220V
Output Voltage	DC: 12V	DC: 12V	DC: 12V	DC: 12V	DC: 12V
Current	2A	3A	5A	8.3A	10A
Material	Metal	Metal	Metal	Metal	Metal
IP Rating	IP20	IP20	IP20	IP20	IP20
Dimension	85x57x34mm	85x57x34mm	115x80x50mm	165x105x50mm	165x105x65mm

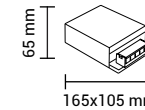
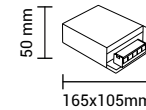
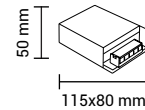
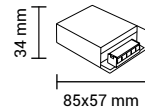
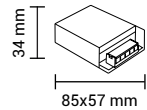

Strip Power Supplies
Metal 12V Output



SKU: 6114	AC150-A3	150W - 12V	3800156661141
SKU: 6117	AC250-A3	250W - 12V	3800156661172
SKU: 6108	AC360-A3	360W - 12V	3800156661080
SKU: 6124	AC500-A3	500W - 12V	3800156661240

Watts	150W	250W	360W	500W
Input Voltage	220V	220V	220V	220V
Output Voltage	DC: 12V	DC: 12V	DC: 12V	DC: 12V
Current	12.5A	20A	30A	41.5A
Material	Metal	Metal	Metal	Metal
IP Rating	IP20	IP20	IP20	IP20
Dimension	205x100x50mm	200x115x55mm	220x115x55mm	220x115x55mm

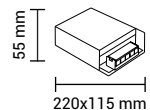
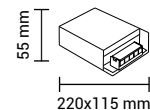
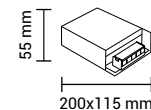
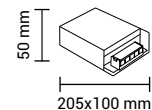

Strip Power Supplies
Metal 24V Output



SKU: 6154	60W - 24V	3800156661547
SKU: 6151	100W - 24V	3800156661516
SKU: 6155	150W - 24V	3800156661554
SKU: 6152	250W - 24V	3800156661523
SKU: 6153	360W - 24V	3800156661530

60W

Product Code	AC60-A4	Current	2.5A
Watts	60W	Material	Metal
Input Voltage	220V	IP Rating	IP20
Output Voltage	DC: 24V	Dimension	165x100x45mm

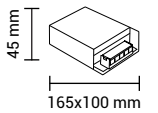

100W

Product Code	AC100-A4	Current	4.2A
Watts	100W	Material	Metal
Input Voltage	220V	IP Rating	IP20
Output Voltage	DC: 24V	Dimension	210x100x45mm

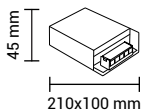

150W

Product Code	AC150-A4	Current	6.25A
Watts	150W	Material	Metal
Input Voltage	220V	IP Rating	IP20
Output Voltage	DC: 24V	Dimension	205x105x50mm

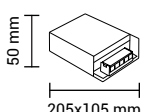

250W

Product Code	AC250-A4	Current	10.5A
Watts	250W	Material	Metal
Input Voltage	220V	IP Rating	IP20
Output Voltage	DC: 24V	Dimension	200x110x50mm

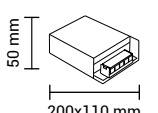

360W

Product Code	AC360-A4	Current	15A
Watts	360W	Material	Metal
Input Voltage	220V	IP Rating	IP20
Output Voltage	DC: 24V	Dimension	220x115x55mm

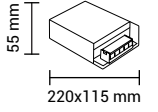



Strip Power Supplies
SLIM - Metal 12V Output



- SKU: 6131 60W - 12V 3800156661318
- SKU: 6132 100W - 12V 3800156661325
- SKU: 6133 150W - 12V 3800156661332
- SKU: 6134 250W - 12V 3800156661349
- SKU: 6135 360W - 12V 3800156661356

60W

Product Code	AC60-A3	Current	5A
Watts	60W	Material	Metal
Input Voltage	220V	IP Rating	IP20
Output Voltage	DC: 12V	Dimension	170x45x38mm

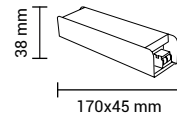

100W

Product Code	AC100-A3	Current	8.5A
Watts	100W	Material	Metal
Input Voltage	220V	IP Rating	IP20
Output Voltage	DC: 12V	Dimension	190x48x38mm

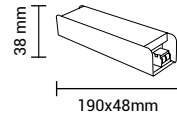

150W

Product Code	AC150-A3	Current	12.5A
Watts	150W	Material	Metal
Input Voltage	220V	IP Rating	IP20
Output Voltage	DC: 12V	Dimension	207x63x49mm

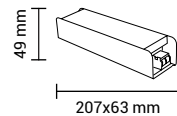

250W

Product Code	AC250-A3	Current	20A
Watts	250W	Material	Metal
Input Voltage	220V	IP Rating	IP20
Output Voltage	DC: 12V	Dimension	230x75x45mm

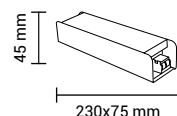

360W

Product Code	AC360-A3	Current	30A
Watts	360W	Material	Metal
Input Voltage	220V	IP Rating	IP20
Output Voltage	DC: 12V	Dimension	230x75x45mm

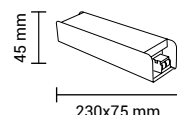

Strip Power Supplies
SLIM - Metal 24V Output



- SKU: 6161 60W - 24V 3800156661615
- SKU: 6162 100W - 24V 3800156661622
- SKU: 6163 150W - 24V 3800156661639
- SKU: 6164 250W - 24V 3800156661646
- SKU: 6165 360W - 24V 3800156661653

60W

Product Code	AC60-A4	Current	2.5A
Watts	60W	Material	Metal
Input Voltage	220V	IP Rating	IP20
Output Voltage	DC: 24V	Dimension	170x45x40mm

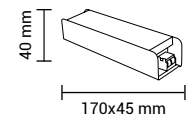

100W

Product Code	AC100-A4	Current	4.2A
Watts	100W	Material	Metal
Input Voltage	220V	IP Rating	IP20
Output Voltage	DC: 24V	Dimension	195x40x40mm

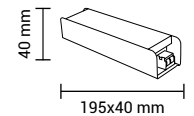

150W

Product Code	AC150-A4	Current	6.25A
Watts	150W	Material	Metal
Input Voltage	220V	IP Rating	IP20
Output Voltage	DC: 24V	Dimension	205x65x45mm

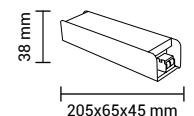

250W

Product Code	AC250-A4	Current	10.5A
Watts	250W	Material	Metal
Input Voltage	220V	IP Rating	IP20
Output Voltage	DC: 24V	Dimension	230x75x45mm

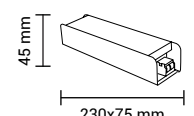

360W

Product Code	AC360-A4	Current	15A
Watts	360W	Material	Metal
Input Voltage	220V	IP Rating	IP20
Output Voltage	DC: 24V	Dimension	230x75x45mm

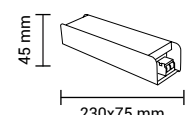

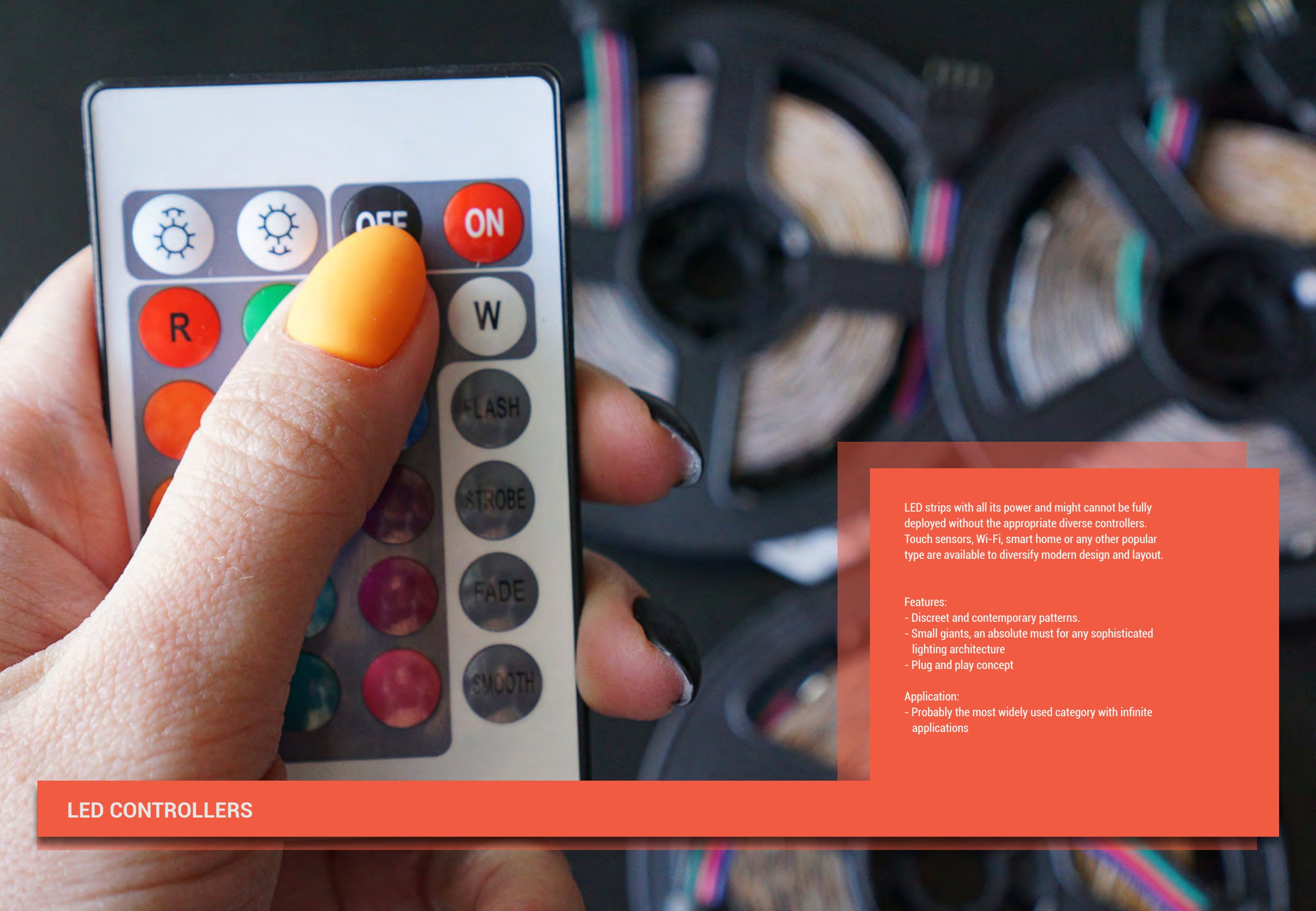

LED strips with all its power and might cannot be fully deployed without the appropriate diverse controllers. Touch sensors, Wi-Fi, smart home or any other popular type are available to diversify modern design and layout.

Features:

- Discreet and contemporary patterns.
- Small giants, an absolute must for any sophisticated lighting architecture
- Plug and play concept

Application:

- Probably the most widely used category with infinite applications

LED CONTROLLERS



**Dimmer LED Strip
With Remote Control 8A**

SKU: 6302
 Product Code AC2-A2
 Power 96W-192W
 Voltage 12V / 24V
 IP Rating IP20
 Dimension 80x55x30mm
 EAN: 3800156663022



**WiFi Controller
RGB / Single Color 3x4A**

SKU: 6310	6311
Product Code AC2-A2	AC2-A2
Power 90W-288W	90W-288W
Voltage 7.5V-24V	7.5V-24V
Strip Type RGB	Single Color
Dimension 80x55x30mm	80x55x30mm
EAN: 3800156663107	3800156663114



**Remote Control LED Strip
RGB - 4 Buttons 3x4A**

SKU: 6304
 Product Code AC2-A2
 Power 144W-288W
 Voltage 12V / 24V
 IP Rating IP20
 Dimension 105x65x20mm
 EAN: 3800156663046



**Amplifier for LED Strip
RGB - Iron Shell 3x8A**

SKU: 6326
 Product Code AC2-A2
 Power 288W-576W
 Voltage 12V-24V
 IP Rating IP20
 Dimension 80x70x30mm
 EAN: 3800156663268



**Remote Control LED Strip
RGB - 16 Buttons 3x2A**

SKU: 6303
 Product Code AC2-A2
 Power 72W
 Voltage 12V
 IP Rating IP20
 Dimension 50x35x20mm
 EAN: 3800156663039



**Amplifier for LED Strip
RGB+White 4x6A**

SKU: 6328
 Product Code AC2-A2
 Power 288W-576W
 Voltage 12V-24V
 IP Rating IP20
 Dimension 65x55x20mm
 EAN: 3800156663282



**Remote Control LED Strip
RGB - 44 Buttons**

SKU: 6306	6307
Product Code AC2-A2	AC2-A2
Power 72W	144W
Voltage 12V	12V
IP Rating IP20	IP20
Dimension 50x35x20mm	50x35x20mm
EAN: 3800156663060	3800156663077



**Amplifier for LED Strip
RGB 3x4A**

SKU: 6305
 Product Code AC2-A2
 Power 144W-288W
 Voltage 12V-24V
 IP Rating IP20
 Dimension 80x55x20mm
 EAN: 3800156663053





**Remote Control LED Strip
RGB Touch White/Black 3x6A**

SKU:	6314	6315
Product Code	AC2-A2	AC2-A2
Power	216W-432W	216W-432W
Voltage	12V / 24V	12V / 24V
Body Color	White	Black
Dimension	95x50x30mm	95x50x30mm
EAN:	3800156663145	3800156663152



**Sensor Dimmer
Wall Mounted 10A**

SKU:	6318
Product Code	AC2-A2
Power	120W-240W
Voltage	12V / 24V
Body Color	Black
Dimension	85x85x40mm
EAN:	3800156663183



**Remote Control LED Strip
RGBW Touch 4x6A**

SKU:	6329
Product Code	AC2-A2
Power	288W-576W
Voltage	12V / 24V
IP Rating	IP20
Dimension	80x45x15mm
EAN:	3800156663299



**Sensor Dimmer
Wall Mounted 10A**

SKU:	6320
Product Code	AC2-A2
Power	120W-240W
Voltage	12V / 24V
Body Color	White
Dimension	85x85x40mm
EAN:	3800156663206



**Music LED Controller
With Remote Control 3x4A**

SKU:	6312
Product Code	AC2-A2
Power	144W-288W
Voltage	12V-24V
IP Rating	IP20
Dimension	170x85x23mm
EAN:	3800156663121



**Sensor Dimmer
Wall Mounted RGB 3x4A**

SKU:	6317
Product Code	AC2-A2
Power	144W-288W
Voltage	12V-24V
IP Rating	IP20
Dimension	85x85x40mm
EAN:	3800156663176



**DMX512 Decoder
3x4A**

SKU:	6308
Product Code	AC2-A2
Power	144W-288W
Voltage	12V-24V
IP Rating	IP20
Dimension	160x60x42mm
EAN:	3800156663084



**Sensor Dimmer
Wall Mounted RGB 3x4A**

SKU:	6319
Product Code	AC2-A2
Power	144W-288W
Voltage	12V-24V
IP Rating	IP20
Dimension	85x85x40mm
EAN:	3800156663190





LED Remote Control Set
Single Color RF 2.4G 3CH 3x4A V3



LED Remote

Output signal RF 2.4GHz
Working voltage 3VDC(CR2032)
Standby time 12 months
Remote distance 30m
Dimension 107x58.5x9mm

LED Receiver

Input voltage 12/24VDC
Output power 144W/288W
Output current 3CH,4A/CH
IP Rating IP20
Dimension 97x33x18mm

SKU: 6348 3800156663480

Professional series



LED Remote Control Set
RGB - RF 2.4G 3CH 3x4A V3



LED Remote

Output signal RF 2.4GHz
Working voltage 3VDC(CR2032)
Standby time 12 months
Remote distance 30m
Dimension 107x58.5x9mm

LED Receiver

Input voltage 12/24VDC
Output power 144W/288W
Output current 3CH,4A/CH
IP Rating IP20
Dimension 97x33x18mm

SKU: 6349 3800156663497

Professional series



RGB+CCT LED Strip Controller Kit
5 channels constant voltage/Step-less dimming



- 5 Channels constant voltage output for RGB+ CCT light
- Ultra sensitive color adjustment touch wheel
- Smooth dimming and switch without any flickering
- Built in 10 dynamic mode, include jump or gradual change style
- Independent dimming function of each R, G, B channel to achieve millions of colors
- Auto-transmitting function: Controller automatically transmit signal to another controller with 30m control distance
- Synchronize on multiple number of controllers
- Light on/off fade time 3s selectable

SKU: 6387 3800156663879

Professional series



Bluetooth & RF 2CH LED Controller
2 Channels/Push-Dim/Wireless control



- Remote control or connected with external push switch to achieve on/off and dimming function
- Ultra sensitive brightness adjustment touch slide
- Smooth dimming and switch without any flickering
- Auto-transmitting function: Controller automatically transmit signal to another controller with 30m control distance
- Synchronize on multiple number of controllers
- Light on/off fade time 3s selectable
- Magnet on the back which can be easily stuck on back holder or any metal surfaces

SKU: 6386 3800156663862

Professional series



LED Single Color Remote Control
Touch - 1 Zone RF 2.4GHZ



- Match with OPTONICA Professional LED Controllers.
- Ultra sensitive color adjustment touch slide.
- Each remote can match one or more receivers.
- Operate with LED indicator light.
- Magnet on the back which can be easily stuck on any metal surfaces
- CR2032 battery powered.



SKU: 6359 3800156663596

Professional series



LED RGB Remote Control
Touch - 1 Zone RF 2.4GHZ



- Match with OPTONICA Professional LED Controllers.
- Ultra sensitive color adjustment touch slide.
- Each remote can match one or more receivers.
- Operate with LED indicator light.
- Magnet on the back which can be easily stuck on any metal surfaces
- CR2032 battery powered.



SKU: 6360 3800156663602

Professional series



LED RGB + CCT Remote Control
Touch - 4 Zone RF 2.4GHZ



- Match with OPTONICA Professional LED Controllers.
- Ultra sensitive color adjustment touch wheel.
- Each remote can match one or more receivers.
- Operate with LED indicator light.
- AAx2 battery powered.
- Dimension 122x53x17.5mm



SKU: 6368 3800156663688

Professional series



LED CCT Remote Control
Touch - 4 Zone RF 2.4GHZ



- Match with OPTONICA Professional LED Controllers.
- Ultra sensitive color adjustment touch wheel.
- Each remote can match one or more receivers.
- Operate with LED indicator light.
- AAx2 battery powered.
- Dimension 122x53x17.5mm



SKU: 6350 3800156663503

Professional series



Wall Mounted Touch Panel
4 Zone/Color wheel/AC input/DMX 512 signal



Input Voltage 12-36VDC Output Current 2CH,5A/CH
Input Current 10.5A Output Power 2x(60-180)W
Output Voltage 2X(12-36)VDC Output Type Constant Voltage

- Used for control single color or color temperature LED strip.
- Tuya APP cloud control, support on/off, color temperature and brightness adjust, delay turn on/off light,
- Each controller can also work as Bluetooth-RF converter, then use Tuya APP to control one or more RF LED controller or RF LED dimming driver synchronously.

SKU: 6376 3800156663763 Professional series



Wall Mounted Touch Panel
4 Zone/Color wheel/AC input/DMX 512 signal



Input Voltage 12-24VDC Output Power 2x(60-180)W
Input Current 10.5A Output Type Constant Voltage
Output Voltage 2X(12-36)VDC

- Used for control single color or color temperature LED strip.
- Tuya APP cloud control, support on/off, color temperature and brightness adjust, delay turn on/off light,
- Each controller can also work as Bluetooth-RF converter, then use Tuya APP to control one or more RF LED controller or RF LED dimming driver synchronously.

SKU: 6377 3800156663770 Professional series



LED Remote Control
Single Color Touch - 2.4GHZ



- Touch panel 4 zone 1 color RF remote.
- Each zone can remote control multiple receivers, LED controller, dimming driver or smart lamp.
- Ultra sensitive high strength glass touch panel with touch color slide in the middle.
- Smooth and accurate adjustment by touching the slide.
- Touch keys with chord tones and LED indicator.
- Free installation, no wiring, removable.
- AAA x 2 battery powered.

SKU: 6375 3800156663756 Professional series



LED Remote Control
RGB/RGBW Touch - 2.4GHZ



- Touch panel 4 zone 1 color RF remote.
- Each zone can remote control multiple receivers, LED controller, dimming driver or smart lamp.
- Ultra sensitive high strength glass touch panel with touch color slide in the middle.
- Smooth and accurate adjustment by touching the slide.
- Touch keys with chord tones and LED indicator.
- Free installation, no wiring, removable.
- AAA x 2 battery powered.

SKU: 6374 3800156663749 Professional series



Ultra thin Touch Wheel RF Remote Controller
4 zone RGB+CCT/Touch color wheel



- Apply to RGB+CCT LED controller.
- Ultra sensitive color adjustment touch wheel.
- Each remote can match one or more receiver.
- CR2032 battery powered.
- Operate with LED indicator light.

SKU: 6381 3800156663817 Professional series



Desk Mount RF Remote Controller
Rotary dimming/CR2032 battery



Output signal RF(2.4GHz) Standby current <10μA
Working voltage 3VDC(CR2032) Standby time 1 year
Working current <5mA Remote distance 30m

- Apply to RGB LED controller.
- Rotate knob to change RGB color, color temperature or brightness, support long press or twice click operation.
- Each remote can match one or more receiver.
- CR2032 battery powered.
- Desk mount, removeable anywhere easily.

SKU: 6379 3800156663794 Professional series



RF Signal Repeater
AC or DC input /Wall junction box mounting



Input Voltage 12-36VDC ; 100-240VAC
Input/Output RF 2.4GHz
RF Control Distance 30m

- Apply for wireless signal extension, greatly ensures RF communication stability and wide controlling area.
- Powered by AC100-240V or DC12-24V.
- Compatibility with RF 2.4G remote control.
- Easy to be placed in standard wall junction box.

SKU: 6382 3800156663824 Professional series



WiFi & RF AC Triac Dimmer
Voice control/RF dimming/Push Dim



Input Voltage AC100-240V Output Current MAX 1.5A
Output Voltage AC100-240V Output Power 150-360W

- WiFi + RF + Push AC phase-cut dimmer, 1 channel output.
- Voice control, support amazon ECHO and TmallGenie smart speaker.
- 256 levels 0-100% dimming smoothly without any flash.
- Compatibility with RF 2.4G single zone or multiple zone dimming remote control.
- Easy to be placed in standard wall junction box behind a push switch.
- Over-heat / Over-load protection, recover automatically.

SKU: 6388 3800156663886 Professional series

NEW



Bluetooth & RF 2CH LED Controller
2 Channels/Push-Dim/Wireless control



Input Voltage	12-36VDC	Output Current	2CH,5A/CH
Input Current	10.5A	Output Power	2x(60-180)W
Output Voltage	2X(12-36)VDC	Output Type	Constant Voltage

- Used for control single color or color temperature LED strip.
- Tuya APP cloud control, support on/off, color temperature and brightness adjust, delay turn on/off light,
- Each controller can also work as Bluetooth-RF converter, then use Tuya APP to control one or more RF LED controller or RF LED dimming driver synchronously.

SKU: 6384 3800156663848 Professional series

NEW



WiFi & RF 5 in 1 LED Controller
Tuya APP cloud control/Voice control/5 Channels



Input Voltage	12-24VDC	Output Current	5CH,3A/CH
Input Current	15.5A	Output Power	5x(36-72)W
Output Voltage	5X(12-24)VDC	Output Type	Constant Voltage

- 5 in 1 function, used for control RGB, RGBW, RGB+CCT, color temperature or single color LED strip.
- Voice control, support amazon ECHO and TmallGenie smart speaker.
- Match with RF 2.4G remote control optional.
- Light on/off fade time 3s selectable.

SKU: 6383 3800156663831 Professional series

NEW



Constant Voltage LED Waterproof Controller
4 Channels/Wireless remote control/Synchronize



Input Voltage	12-36VDC	Output Current	4CH,5A/CH
Input Current	20.5A	Output Power	4x(60-180)W
Output Voltage	4X(12-36)VDC	Output Type	Constant Voltage

- When using with RGB/RGBW light, built in 10 dynamic mode, include jump or gradual change style.
- Auto-transmitting function: Controller automatically transmit signal to another controller with 30m control distance.
- Synchronize on multiple number of controllers.
- Fade in and out effect selectable.

SKU: 6380 3800156663800 Professional series

NEW



Constant Voltage Waterproof Power Repeater
4 Channel/PWM signal input



Input Voltage	12-36VDC	Output Current	4CH,5A/CH
Input Current	20.5A	Output Power	4x(60-180)W
Output Voltage	4X(12-36)VDC	Output Type	Constant Voltage

- Waterproof 12-36V constant voltage power repeater with IP67 rating, suitable for outdoor and damp environment.
- 4 channel, 5A per channel.
- To receive PWM signal control.
- Power repeater in series or in parallel to expand output unlimitedly.
- Apply to single color, dual color, RGB or RGBW constant voltage LED strip or module.

SKU: 6395 3800156663954 Professional series

NEW



6 Channel DMX Sliding Fader Console
6 Sliding Faders / Real DMX Value LED Screen



- Ideal Cost Efficient 6 Channel Mini DMX Fader Console
- Easy Usage
 - Suitable for permanent installations by using available brackets
 - Ideal for Sample Testing and Trouble-Shooting on-site or workshops
 - Powered by 3 x AAA Batteries or external 5-12V Power-Supply
 - 3 Digit LED Screen 0-100% or DMX000-DMX255 (Settings by internal DIP-Switch)
 - 6 Channel Mode or 5 Channel & Master Mode (Settings by internal DIP-Switch)

SKU: 6392 3800156663923 Professional series

NEW



Constant Voltage DMX512 & RDM Decoder
Linear or logarithmic dimming/Numeric display



- Comply with the DMX512 standard protocols.
- Digital numeric display, set DMX decode start address by buttons.
 - RDM function can realize intercommunication between DMX decoder address can be set by DMX master console.
 - 1/2/4 DMX channel output selectable.
 - 16bit (65536 levels) /8bit (256 levels) grey level selectable.
 - Stand-alone RGB/RGBW mode and 4 channel dimmer mode selectable, which be controlled by buttons with built-in programs, instead of DMX signal.

SKU: 6390 3800156663909 Professional series

NEW



4 Ways DMX Signal Splitter
DMX512-A compatible



- One DMX512 signal input, repeat four DMX512 signal output, each allowing for 32 DMX devices to be connected.
- Dedicated to amplify, distribute and insulate the signal that comes from the lighting system equipment when it is connected to the bus of DMX512(or RS-485).
- Input isolated from outputs to 500VAC, 1000VDC.
- Outputs are isolated from each other to 500VAC, 1000VDC.
- Input and outputs are ture RS-485 rated, and no microprocessors are used for maximum reliability.

SKU: 6391 3800156663916 Professional series

NEW



Constant Voltage Power Repeater
5 Channel/PWM signal input/Constant voltage



- 12-24V constant voltage power repeater.
- 5 channel, 5A per channel.
- To receive PWM signal control.
- Power repeater in series or in parallel to expand output unlimitedly.
- Apply to RGB+CCT constant voltage LED strip or module.

SKU: 6396 3800156663961 Professional series

NEW



Constant Voltage Power Repeater
1 Channel/PWM signal input



Input Voltage	12-24VDC	Output Current	15A
Input Current	15.5A	Output Power	180-360W
Output Voltage	12-36VDC	Output Type	Constant Voltage

- 12-24V constant voltage power repeater.
- one channel, 15A.
- To receive PWM signal control.
- Power repeater in series or in parallel to expand output unlimitedly.
- Apply to single color constant voltage LED strip or module.

SKU: 6393 3800156663930 Professional series

NEW



PIR Sensor Stair Light Controller
PIR sensor/Daylight Sensor/Max 32 step



Input Voltage	5-24VDC	Output Current	32CH,1A/CH
Output Voltage	32 x (5-24)VDC	Output Power	32 x (5-24)W
Output Type	Constant Voltage+SPI(TTL)		

- Multiple function PIR sensor stair light controller with daylight sensor.
- 32 channels constant voltage output drive low voltage LED strip, Max. 1A
- Built-in multiple color mode, speed and brightness 1-8 grade adjustable.
- Push switch can also be as induction signal input.
- With fast self-testing function.
- Any damaged LED channel in 32 channels can be set disable.

SKU: 6385 3800156663855 Professional series

NEW



12-60V Constant Voltage Power Repeater
4 Channel/12-60V/PWM signal input



Input Voltage	12-60VDC	Output Current	4CH,5A/CH
Input Current	20A	Output Power	4x(60-300)W
Output Voltage	4X(12-60)VDC	Output Type	Constant Voltage

- 12-60V constant voltage power repeater.
- 3/4 channel, 5A max. per channel.
- To receive PWM signal control.
- Power repeater in series or in parallel to expand output unlimitedly.
- Apply to single color, dual color, RGB or RGBW constant voltage LED strip or module.

SKU: 6394 3800156663947 Professional series

NEW



RGB LED Mini Controller without remote
3 channel constant voltage/Max 4.5A output



Input Voltage	12-24VDC	Output Current	3CH,1.5A/CH
Output Voltage	12-24VDC	Output Type	Constant Voltage

- 3 channel constant voltage RGB LED mini controller.
- 3 key operation with on/off, mode and color adjustment.
- 1.5A per channel, output connect with 5 meters RGB LED strip.
- 256 levels 0-100% dimming smoothly without any flash.
- Built in 10 dynamic mode, include jump or gradual change style.

SKU: 6378 3800156663787 Professional series

NEW



Dimming High Voltage LED Strip Controller
3 Channels/Step-less dimming/Wireless control



Input Voltage	110-240VAC	Output Current	3CH,1A/CH
Input Current	3.2A	Output Power	3x(110-240)W
Output Voltage	3X(110-240)VDC		

- 3 channel high voltage LED strip RF 2.4G controller
- Match with RF 2.4G single zone or multiple zone single color, dual color and RGB/RGBW remote control.
- One RF controller accept up to 10 remote control.
- When using with RGB light, built in 10 dynamic mode, include jump or gradual change style.

SKU: 6397 3800156663978 Professional series

NEW



DMX512 /0-10V to Triac Dimmer
RDM/Stand-alone function/Numeric display/



Input Voltage	100-240VAC	Output Current	1CH,6A/CH
Output Voltage	100-240VAC	Output Power	600-1440W

- AC phase-cut mosfet dimmer with DMX512 function, one channel output.
- Comply with the DMX512 standard protocols.
- Digital numeric display, set DMX decode start address by buttons.
- Reverse-phase dimming or forward-phase dimming selectable.
- Minimum brightness set from 1% to 40%.
- Stand-alone dynamic mode and dimmer mode selectable, which be controlled by buttons with built-in programs, instead of DMX signal.

SKU: 6389 3800156663893 Professional series



Wall mounted holder for 6345
SKU: 6347



**LED RGB/RGBW Remote Control
4 Zone RF 2.4GHZ**

Professional series

- * Match with OPTONICA Professional LED Controllers.
- * Ultra sensitive color adjustment touch wheel.
- * Each remote can match one or more receivers.
- * Operate with LED indicator light.
- * AAAx2 battery powered.
- * Dimension 122x53x17.5mm

SKU: 6345 3800156663459



IP20



Dimmable



Battery

**LED Controller
3 Channel x 4A**

Professional series



IP20



SKU:	6353	Output Voltage	3X(12-24)VDC
Product Code	AC2-A3	Output Current	3CH,4A/CH
Input Voltage	12-24VDC	Output Power	144/288W
Input Current	12.5A	Output Type	Constant Voltage
Input Signal	RF2.4Ghz	Dimension	96x33x17 mm

- * Match with OPTONICA Professional Series Remote Controls.
- * One RF controller accept up to 10 remote control.
- * Build in 10 dynamic mode, include jump or gradual change style.
- * Auto-transmitting function: Controller automatically transmit signal of another controller with 30m control distance.
- *Synchronize on multiple number of controllers.

EAN Code: 3800156663695

**LED Controller
4 Channel x 5A**

Professional series



IP20



SKU:	6342	Output Voltage	4x(12-36)VDC
Product Code	AC2-A3	Output Current	4CH,5A/CH
Input Voltage	12-36VDC	Output Power	4x(60-180)W
Input Current	20.5A	Output Type	Constant Voltage
Input Signal	RF2.4Ghz+Push	Dimension	175x45x27 mm

- * Match with OPTONICA Professional Series Remote Controls.
- * One RF controller accept up to 10 remote control.
- * Build in 10 dynamic mode, include jump or gradual change style.
- * Auto-transmitting function: Controller automatically transmit signal of another controller with 30m control distance.
- *Synchronize on multiple number of controllers.
- *Connect with external push switch to achive on/off and dimming function.

EAN Code: 3800156663428

**LED Controller
4 Channel x 300mA Constant Current**

Professional series



IP20



SKU:	6343	Output Voltage	4x(12-48)VDC
Product Code	AC2-A3	Output Current	4CH,300mA/CH
Input Voltage	12-48VDC	Output Power	4x(3.6-14.4)W
Input Current	1.5A	Output Type	Constant Current
Input Signal	RF2.4Ghz+Push	Dimension	175x45x27 mm

- * Match with OPTONICA Professional Series Remote Controls.
- * One RF controller accept up to 10 remote control.
- * Build in 10 dynamic mode, include jump or gradual change style.
- * Auto-transmitting function: Controller automatically transmit signal of another controller with 30m control distance.
- *Synchronize on multiple number of controllers.
- *Connect with external push switch to achive on/off and dimming function.

EAN Code: 3800156663435



**LED RGB/RGBW Remote Control
4 Zone RF 2.4GHZ**

Professional series

- * Match with OPTONICA Professional LED Controllers.
- * Ultra sensitive color adjustment touch wheel.
- * Each remote can match one or more receivers.
- * Slim and light
- * CR2032 battery powered.
- * Dimension 107x58.5x9mm

SKU: 6344 3800156663442



IP20



Dimmable



Battery



Wall mounted holder for 6341
SKU: 6346



**LED Remote Control
4 Zone Single Color RF 2.4GHZ**

Professional series

- * Match with OPTONICA Professional LED Controllers.
- * Each remote can match one or more receivers.
- * Slim and light
- * IP20
- * CR2032 battery powered.
- * Dimension 135x40x11 mm

SKU: 6341 3800156663411



IP20



Dimmable



Battery



Wall mounted holder for 6340
SKU: 6346



**LED Remote Control
1 Zone CCT RF 2.4GHZ**

Professional series

- * Match with OPTONICA Professional LED Controllers.
- * Each remote can match one or more receivers.
- * Slim and light.
- * IP20
- * CR2032 battery powered.
- * Dimension 107x58.5x9mm

SKU: 6340 3800156663404



IP20



Dimmable



Battery

DMX512 & RDM Decoder 4 Channel x 5A

Professional series



IP20



SKU:	6364	Output Voltage	12-24VDC
Product Code	AC2-A3	Output Current	4CH,5A/CH
Input Voltage	12-24VDC	Output Power	4x(60-120)W
Input Current	20.5A	Output Type	Constant Voltage
IP Rating	IP20	Dimension	170x50x24 mm

- * Match with OPTONICA Professional Series Remote Controls.
- * Comply with the DMX512 standard protocols.
- * Digital numeric display, set DMX address by buttons.
- * RDM function can realize intercommunication between DMX master and decoder.
- * 1/2/4 DMX channel output selectable.
- * Stand-alone RGB/RGBW mode and 4 channel dimmer mode selectable.

EAN Code: 3800156663640

LED Controller 5 Channel x 5A

Professional series



IP20



SKU:	6366	Output Voltage	5x(12-24)VDC
Product Code	AC2-A3	Output Current	5CH,5A/CH
Input Voltage	12-24VDC	Output Power	5x(60-120)W
Input Current	25.5A	Output Type	Constant Voltage
IP Rating	IP20	Dimension	175x45x27 mm

- * Match with OPTONICA Professional Series Remote Controls.
- * One RF controller accept up to 10 remote control.
- * Build in 10 dynamic mode, include jump or gradual change style.
- * Auto-transmitting function: Controller automatically transmit signal of another controller with 30m control distance.
- * Synchronize on multiple number of controllers.
- * Connect with external push switch to achieve on/off and dimming function.

EAN Code: 3800156663664

LED Dimmer 1 Channel 12A

Professional series



IP20



SKU:	6367	Output Voltage	12-36VDC
Product Code	AC2-A3	Output Current	1CH,12A
Input Voltage	12-36VDC	Output Power	144-432W
Input Current	12.5A	Output Type	Constant Voltage
Input Signal	0/1-10V+Push	Dimension	175x45x27 mm

- * Match with OPTONICA Professional Series Remote Controls.
- * 1 channel 0/1-10V LED dimming driver with push-dim function.
- * 1 channel 0/1-10V input, 1 channel PWM constant voltage output.
- * 0~100% dimming range via logarithmic characteristic can be very comfortable for human eyes.

EAN Code: 3800156663671

LED Dimmer 4 Channel x 5A

Professional series



IP20



SKU:	6369	Output Voltage	12-36VDC
Product Code	AC2-A3	Output Current	4CH,5A/CH
Input Voltage	12-36VDC	Output Power	4x(60-180)W
Input Current	20.5A	Output Type	Constant Voltage
Input Signal	0/1-10V+Push	Dimension	175x45x27 mm

- * Match with OPTONICA Professional Series Remote Controls.
- * 4 channel 0/1-10V LED dimming driver with push-dim function.
- * 4 channel 0/1-10V input, 4 channel PWM constant voltage output.
- * 0~100% dimming range via logarithmic characteristic can be very comfortable for human eyes.

EAN Code: 3800156663695

DALI LED Dimmer 1 Channel 15A

Professional series



IP20



SKU:	6371	Output Voltage	12-24VDC
Product Code	AC2-A3	Output Current	1CH,15A
Input Voltage	12-24VDC	Output Power	180W/360W
Input Current	15A	Output Type	Constant Voltage
Input Signal	DALI+Push	Dimension	175x45x27 mm

- * Match with OPTONICA Professional Series Remote Controls.
- * Constant voltage DALI LED dimmer with 1 channel, 15A output.
- * DALI address will be automatically assigned by DALI master, 1 DALI address.
- * PWM digital dimming, standard DALI logarithmic dimming curve.
- * Connect with external push switch to achieve on/off and dimming function.

EAN Code: 3800156663718

DALI LED Dimmer 4 Channel x 5A

Professional series



IP20



SKU:	6372	Output Voltage	12-24VDC
Product Code	AC2-A3	Output Current	4CH,5A/CH
Input Voltage	12-24VDC	Output Power	4x(60-120)W
Input Current	20.5A	Output Type	Constant Voltage
Input Signal	DALI	Dimension	175x45x27 mm

- * Match with OPTONICA Professional Series Remote Controls.
- * 4 channel constant voltage DALI LED Dimmer, 5A per channel.
- * 4 DALI address, 4 channel work separately.
- * DALI address will be automatically assigned by DALI master.
- * PWM digital dimming, standard DALI logarithmic dimming curve.

EAN Code: 3800156663725

LED Controller

Professional series



IP20



SKU:	6355	Output Voltage	4x(12-24)VDC
Product Code	AC2-A3	Output Current	4CH,5A/CH
Input Voltage	12-24VDC	Output Power	4x(60-120)W
Input Current	20.5A	Output Type	Constant Voltage
IP Rating	IP20	Dimension	110x64x45mm

- * Match with OPTONICA Professional Series Remote Controls.
- * Digital numeric display and easy key operation.
- * Can set as 1 channel dimmer, 4 channel, dual color, RGB or RGBW controller.
- * Logarithmic or linear dimming curve selectable.
- * Synchronize on multiple number of controllers.

EAN Code: 3800156663558

AC TRIAC Dimmer

Professional series



IP20



SKU:	6365	Output Voltage	100-240VAC
Product Code	AC2-A3	Output Current	1CH,2A/CH
Input Voltage	100-240VAC	Output Power	200-480W
Input Signal	RF2.4GHz+Push	Dimming level	100 levels
IP Rating	IP20	Dimension	110x64x45 mm

- * Match with OPTONICA Professional Series Remote Controls.
- * RF+ Push AC phase-cut dimmer, 1channel output.
- * Digital numeric display , set brightness by bottons.
- * 0-100% dimming smoothly without any flash.
- * Reverse-phase dimming or forward-phase dimming selectable.
- * Minimum brightness set from 1% to 40%

EAN Code: 3800156663657

Power Repeater

Professional series



IP20



SKU:	6370	Output Voltage	4x(12-24)VDC
Product Code	AC2-A3	Output Current	4CH,5A/CH
Input Voltage	12-24VDC	Output Power	4x(60-120)W
Input Current	20.5A	Output Type	Constant Voltage
IP Rating	IP20	Dimension	110x64x45 mm

- * Match with OPTONICA Professional Series Remote Controls.
- * To receive PWM signal control.
- * Power repeater in seris or in parallel to expand output unlimitedly.
- * Apply to single color,dual color,RGB or RGBW constant voltage LED strip or module.
- * 3KV Optoelectronic isolation.

EAN Code: 3800156663701

**AC Triac RF Dimmer
RF 2.4GHz + Push**

Professional series



IP20



SKU:	6363	Output Voltage	100-240VAC
Product Code	AC2-A3	Output Current	MAX 1A
Input Voltage	100-240VAC	Output Power	100-240W
Input Signal	RF2.4GHz+Push	Dimming level	256 levels
IP Rating	IP20	Dimension	56x56x26 mm

- * Match with OPTONICA Professional Series Remote Controls.
- * RF+ Push AC phase-cut dimmer, 1channel output.
- * 0-100% dimming smoothly without any flash.
- *Connect with external push switch to achive ON/OFF and dimming function.
- * Easy to be inserted into standard 86x86mm wall box

EAN Code: 3800156663633

**LED Controller
3 Channel x 10A**

Professional series



IP20



SKU:	6356	Output Voltage	3x(12-36)VDC
Product Code	AC2-A3	Output Current	3CH,10A/CH
Input Voltage	12-36VDC	Output Power	3x(120-360)W
Input Current	30.5A	Output Type	Constant Current
Input Signal	RF2.4GHz	Dimension	105x75x25 mm

- * Match with OPTONICA Professional Series Remote Controls.
- * One RF controller accept up to 10 remote control.
- * Build in 10 dynamic mode, include jump or gradual change style.
- * Auto-transmitting function: Controller automaticly transmit signal of another controller with 30m control distance.
- *Synchronize on multiple number of controllers.

EAN Code: 3800156663565

**WiFi - Relay 2.4GHz
WiFi to RF Converter**

Professional series



IP20



SKU:	6354	Output Control	RGB,RGBW,CT
Product Code	AC2-A3	Working Temp.	-20°C~50°C
Input Voltage	5-24VDC	Platform	iOS , Android
Wifi standard	802.11 b/g/n	Dimension	ø72x25 mm

EAN Code: 3800156663541





**LED Single Color Controller
4A*3CH**

Professional series



Dimmable



IP20

SKU:	6357	Output Voltage	3x(12-24)VDC
Product Code	AC2-A3	Output Current	3CH,4A/CH
Input Voltage	12-24VDC	Output Power	144-288W
Input Current	12.5A	Output Type	Constant Voltage
IP Rating	IP20	Dimension	86x86x53 mm

EAN Code: 3800156663572



**LED RGB Controller
4A*3CH**

Professional series



Dimmable



IP20

SKU:	6358	Output Voltage	3x(12-24)VDC
Product Code	AC2-A3	Output Current	3CH,4A/CH
Input Voltage	12-24VDC	Output Power	144-288W
Input Current	12.5A	Output Type	Constant Voltage
IP Rating	IP20	Dimension	86x86x53 mm

EAN Code: 3800156663589



**LED DMX Controller
4 Zones control DMX512+RF 2.4G**

Professional series



Dimmable



IP20

SKU:	6361	Control Mode	4 Zone Control
Product Code	AC2-A3	Light Type	Single Color
Input Voltage	85-265V	Remote Distance	30m
Output Signal	DMX512+RF	Working Temp.	-20°C/+50°C
IP Rating	IP20	Dimension	86x86x36 mm

EAN Code: 3800156663619



**LED RGBW DMX Controller
4 Zones control DMX512+RF 2.4G**

Professional series



Dimmable



IP20

SKU:	6362	Control Mode	4 Zone Control
Product Code	AC2-A3	Light Type	RGBW
Input Voltage	85-265V	Remote Distance	30m
Output Signal	DMX512+RF	Working Temp.	-20°C/+50°C
IP Rating	IP20	Dimension	86x86x36 mm

EAN Code: 3800156663626

ACCESSORIES FOR LED STRIPS



CONNECTOR FOR STRIP 3528
SKU: 5151 38001566651517



CONNECTOR FOR STRIP 5050
SKU: 5152 38001566651524



CONNECTOR FOR STRIP RGB
SKU: 6608 3800156666085



ANGLE CONNECTOR FOR STRIP 3528 8mm
SKU: 6619 3800156666191



ANGLE CONNECTOR FOR STRIP 5050 10mm
SKU: 6620 3800156666207



ANGLE CONNECTOR FOR STRIP RGB 10mm
SKU: 6621 3800156666214



CONNECTOR FOR STRIP DC MALE
SKU: 6610 3800156666108



CONNECTOR FOR STRIP DC FEMALE
SKU: 6611 3800156666115



FLEXIBLE FOR STRIP 3528 DC FEMALE
SKU: 6612 3800156666122



FLEXIBLE FOR STRIP 5050 DC FEMALE
SKU: 6613 3800156666139



FLEXIBLE CONNECTOR FOR LED STRIP RGB
SKU: 6614 3800156666146



FLEXIBLE CONNECTOR FOR LED STRIP 5050
SKU: 6615 3800156666153



FLEXIBLE CONNECTOR FOR LED STRIP 5050
SKU: 6616 3800156666160



FLEXIBLE CONNECTOR FOR STRIP RGB+WH
SKU: 6618 3800156666184



FLEXIBLE FOR RGB LED STRIP WITH PIN
SKU: 6617 3800156666177



Highly specialized luminaires with concentrated light distribution angle intended for retail or other spot required presentation area. These adjustable fixtures can be combined with variously lengthen three phased tracks along with connectors to suit every design, including rapid solutions for trade fair halls and shopping malls.

Features:

- Three colour temperatures offered to match the needs of most commercial shelf products
- Upto 80% cost-saving use
- Quick and easy fool proof on and off installation

Application:

- Indoor use
- Any show-room, art gallery, dining rooms companions.
- Popular choice for both residential and commercial projects.

LED LINEAR AND TRACK LIGHTS

**LED Linear Suspended Light
40W Slim**



Product code	LN40-A1	CRI	Ra>80
Watts	40W	IP Rating	IP20
Input Voltage	AC : 200-240V	Dimension	1200x35x67 mm
Flux	3400lm	Body Color	BLACK
Beam Angle	120°	Dimmable	NO

SKU: 5372 White Light 6000K 3800156653726
 SKU: 5371 Neutral White 4000K 3800156653719

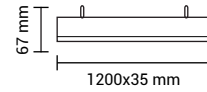

**LED Linear Suspended Light
40W Slim**

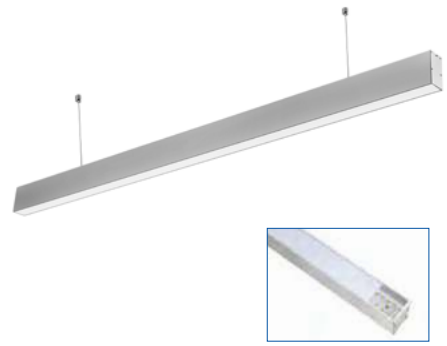

Product code	LN40-A1	CRI	Ra>80
Watts	40W	IP Rating	IP20
Input Voltage	AC : 200-240V	Dimension	1200x35x67 mm
Flux	3400lm	Body Color	SILVER
Beam Angle	120°	Dimmable	NO

SKU: 5374 White Light 6000K 3800156653740
 SKU: 5373 Neutral White 4000K 3800156653733

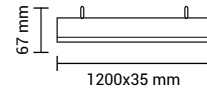

**LED Linear Suspended Light
40W Slim**



Product code	LN40-A1	CRI	Ra>80
Watts	40W	IP Rating	IP20
Input Voltage	AC : 200-240V	Dimension	1200x35x67 mm
Flux	3400lm	Body Color	WHITE
Beam Angle	120°	Dimmable	NO

SKU: 5376 White Light 6000K 3800156653764
 SKU: 5375 Neutral White 4000K 3800156653757

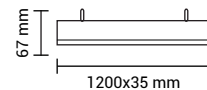

**LED Linear Recessed Light
40W Linkable**



Linkable

Product code	LN40-A2	CRI	Ra>80
Watts	40W	IP Rating	IP20
Input Voltage	AC : 200-240V	Dimension	1211x35x70 mm
Flux	3400lm	Body Color	WHITE
Beam Angle	120°	Dimmable	NO

SKU: 5377 Neutral White 4000K 3800156653771

Connectors for LED Linear Recessed Lights



L-SHAPE CONNECTOR

SKU:	5031
Light Color	4000K
Watts	8W
Input Voltage	AC:200-240V
Dimension	136x136x35mm



L-SHAPE CONNECTOR

SKU:	5032
Light Color	4000K
Watts	8W
Input Voltage	AC:200-240V
Dimension	134x134x35mm



L-SHAPE CONNECTOR

SKU:	5033
Light Color	4000K
Watts	8W
Input Voltage	AC:200-240V
Dimension	181x181x35mm



T-SHAPE CONNECTOR

SKU:	5034
Light Color	4000K
Watts	12W
Input Voltage	AC:200-240V
Dimension	255x127x35mm



X-SHAPE CONNECTOR

SKU:	5035
Light Color	4000K
Watts	16W
Input Voltage	AC:200-240V
Dimension	255x255x35mm



**LED Linear Suspended Light
40W Slim Linkable**



5 Years
Warranty



Linkable

Product code	LN40-A3	CRI	Ra>80
Watts	40W	IP Rating	IP20
Input Voltage	AC : 200-240V	Dimension	1185x60x70 mm
Flux	4000lm	Body Color	BLACK
Beam Angle	120°	Dimmable	NO

SKU: 5380 Neutral White 4000K 3800156653801

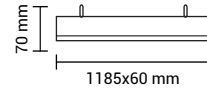

**LED Linear L-Shape Connector
10W Slim Linkable**



5 Years
Warranty

Product code	LN10-A3	CRI	Ra>80
Watts	10W	IP Rating	IP20
Input Voltage	AC : 200-240V	Dimension	176x176x70 mm
Flux	1000lm	Body Shape	L-Shape
Beam Angle	120°	Dimmable	NO

SKU: 5027 Black Body 3800156653726 for SKU:5380
 SKU: 5028 Silver Body 3800156653719 for SKU:5381
 SKU: 5029 White Body 3800156653719 for SKU:5382

**LED Linear Suspended Light
40W Slim Linkable**



5 Years
Warranty



Linkable

Product code	LN40-A3	CRI	Ra>80
Watts	40W	IP Rating	IP20
Input Voltage	AC : 200-240V	Dimension	1185x60x70 mm
Flux	4000lm	Body Color	SILVER
Beam Angle	120°	Dimmable	NO

SKU: 5381 Neutral White 4000K 3800156653818

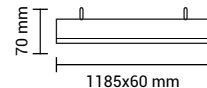

**LED Linear T-Shape Connector
15W Slim Linkable**

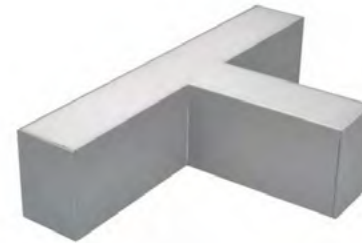

5 Years
Warranty

Product code	LN15-A3	CRI	Ra>80
Watts	15W	IP Rating	IP20
Input Voltage	AC : 200-240V	Dimension	300x176x70 mm
Flux	1500lm	Body Shape	T-Shape
Beam Angle	120°	Dimmable	NO

SKU: 5030 Black Body 3800156650305 for SKU:5380
 SKU: 5036 Silver Body 3800156650367 for SKU:5381
 SKU: 5037 White Body 3800156650374 for SKU:5382

**LED Linear Suspended Light
40W Slim Linkable**

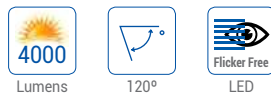

5 Years
Warranty



Linkable

Product code	LN40-A3	CRI	Ra>80
Watts	40W	IP Rating	IP20
Input Voltage	AC : 200-240V	Dimension	1185x60x70 mm
Flux	4000lm	Body Color	WHITE
Beam Angle	120°	Dimmable	NO

SKU: 5382 Neutral White 4000K 3800156653825

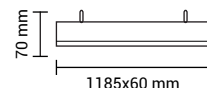

**LED Linear X-Shape Connector
20W Slim Linkable**



5 Years
Warranty

Product code	LN20-A3	CRI	Ra>80
Watts	20W	IP Rating	IP20
Input Voltage	AC : 200-240V	Dimension	300x300x70 mm
Flux	2000lm	Body Shape	X-Shape
Beam Angle	120°	Dimmable	NO

SKU: 5038 Black Body 3800156650381 for SKU:5380
 SKU: 5039 Silver Body 3800156650398 for SKU:5381
 SKU: 5040 White Body 3800156650404 for SKU:5382

LED Linear Suspended Light
50W UP-DOWN



Product code	LN50-A3	CRI	Ra>80
Watts	50W	IP Rating	IP20
Input Voltage	AC : 200-240V	Dimension	1185x28x68 mm
Flux	5000lm	Body Color	BLACK
Beam Angle	120°	Dimmable	NO



SKU: 5383 Neutral White 4000K 3800156653832

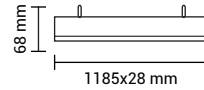

LED Linear Suspended Light
50W Linkable

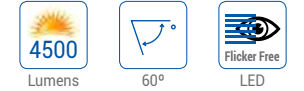

Product code	LN50-A4	CRI	Ra>80
Watts	50W	IP Rating	IP20
Input Voltage	AC : 200-240V	Dimension	1200x35x67 mm
Flux	4500lm	Body Color	BLACK
Beam Angle	60°	Dimmable	NO



Connector
SKU: 5047

SKU: 5386 Neutral White 4000K 3800156653863

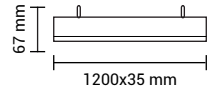

LED Linear Suspended Light
50W UP-DOWN

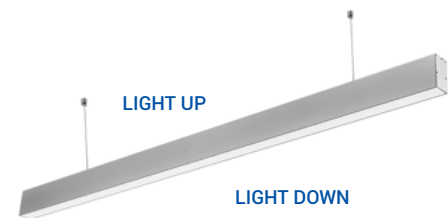

Product code	LN50-A3	CRI	Ra>80
Watts	50W	IP Rating	IP20
Input Voltage	AC : 200-240V	Dimension	1185x28x68 mm
Flux	5000lm	Body Color	SILVER
Beam Angle	120°	Dimmable	NO



SKU: 5384 Neutral White 4000K 3800156653849

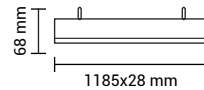

LED Linear Suspended Light
50W Linkabe

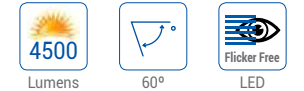

Product code	LN50-A4	CRI	Ra>80
Watts	50W	IP Rating	IP20
Input Voltage	AC : 200-240V	Dimension	1200x35x67 mm
Flux	4500lm	Body Color	SILVER
Beam Angle	60°	Dimmable	NO



Connector
SKU: 5047

SKU: 5387 Neutral White 4000K 3800156653870

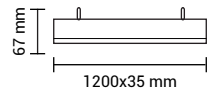

LED Linear Suspended Light
50W UP-DOWN

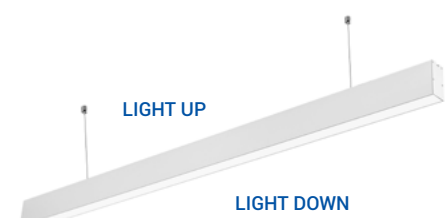

Product code	LN50-A3	CRI	Ra>80
Watts	50W	IP Rating	IP20
Input Voltage	AC : 200-240V	Dimension	1185x28x68 mm
Flux	5000lm	Body Color	WHITE
Beam Angle	120°	Dimmable	NO



SKU: 5385 Neutral White 4000K 3800156653856

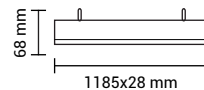

LED Linear Suspended Light
50W Linkable

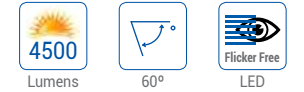

Product code	LN50-A4	CRI	Ra>80
Watts	50W	IP Rating	IP20
Input Voltage	AC : 200-240V	Dimension	1200x35x67 mm
Flux	4500lm	Body Color	WHITE
Beam Angle	60°	Dimmable	NO



Connector
SKU: 5047

SKU: 5388 Neutral White 4000K 3800156653887

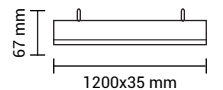

LED Wall washer for Tracks
30W For 3 Phase 4 Line Tracks



Product code	LN30-A3	CRI	Ra>80
Watts	30W	IP Rating	IP20
Input Voltage	AC : 200-240V	Dimension	610x40x90 mm
Flux	2700lm	Body Color	BLACK
Beam Angle	24°	Dimmable	NO

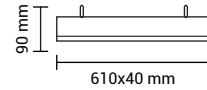

SKU: 5389 Neutral White 4000K 3800156653894



LED Wall washer for Tracks
40W For 3 Phase 4 Line Tracks



Product code	LN40-A4	CRI	Ra>80
Watts	40W	IP Rating	IP20
Input Voltage	AC : 200-240V	Dimension	9050x40x90 mm
Flux	3600lm	Body Color	BLACK
Beam Angle	24°	Dimmable	NO

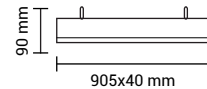

SKU: 5390 Neutral White 4000K 3800156653900



LED COB Track Light
25W For 3 Phase 4 Line Tracks



Product code	FL25-A1	CRI	Ra>80
Watts	25W	IP Rating	IP20
Input Voltage	AC : 220-240V	Dimension	ø80x145x160mm
Flux	2750lm	Body Color	WHITE
Beam Angle	24°		

SKU: 5321 White Light 5000K 3800156653214
SKU: 5322 Neutral White 4500K 3800156653221
SKU: 5323 Warm White 3000K 3800156653238

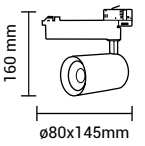

LED COB Track Light
25W For 3 Phase 4 Line Tracks



Product code	FL25-A1	CRI	Ra>80
Watts	25W	IP Rating	IP20
Input Voltage	AC : 220-240V	Dimension	ø80x145x160mm
Flux	2750lm	Body Color	BLACK
Beam Angle	24°		

SKU: 5327 White Light 5000K 3800156653276
SKU: 5328 Neutral White 4500K 3800156653283
SKU: 5329 Warm White 3000K 3800156653290

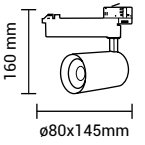

LED COB Track Light
35W For 3 Phase 4 Line Tracks



Product code	WL35-A1	CRI	Ra>80
Watts	35W	IP Rating	IP20
Input Voltage	AC : 220-240V	Dimension	ø90x160x160mm
Flux	3850lm	Body Color	WHITE
Beam Angle	24°		

SKU: 5324 White Light 5000K 3800156653245
SKU: 5325 Neutral White 4500K 3800156653252
SKU: 5326 Warm White 3000K 3800156653269

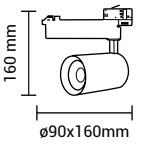

LED COB Track Light
35W For 3 Phase 4 Line Tracks



Product code	WL35-A1	CRI	Ra>80
Watts	35W	IP Rating	IP20
Input Voltage	AC : 220-240V	Dimension	ø90x160x160mm
Flux	3850lm	Body Color	BLACK
Beam Angle	24°		

SKU: 5330 White Light 5000K 3800156653306
SKU: 5331 Neutral White 4500K 3800156653313
SKU: 5332 Warm White 3000K 3800156653320

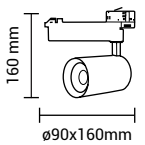

ACCESSORIES FOR TRACK LIGHTS



TRACK SYSTEM - 1M WHITE
SKU: 5153



TRACK SYSTEM - 1M BLACK
SKU: 5154



TRACK SYSTEM - 2M WHITE
SKU: 5156



TRACK SYSTEM - 2M BLACK
SKU: 5155



CONNECTOP ANGLE - WHITE
SKU: 5157



CONNECTOP LINE - BLACK
SKU: 5159



CONNECTOP ANGLE - WHITE
SKU: 5158



CONNECTOP ANGLE - BLACK
SKU: 5160



ACCESSORIES FOR 3-PHASE TRACK LIGHTS



TRACK SYSTEM 3PHASES - 1M WHITE
SKU: 5007



TRACK SYSTEM 3PHASES - 1M BLACK
SKU: 5009



TRACK SYSTEM 3PHASES - 2M WHITE
SKU: 5008



TRACK SYSTEM 3PHASES - 2M BLACK
SKU: 5010



STRAIGHT CONNECTOR WHITE
SKU: 5013



MINI STRAIGHT CONNECTOR WHITE
SKU: 5011



T-CONNECTOR WHITE
SKU: 5017



END CAP WHITE
SKU: 5023



STRAIGHT CONNECTOR BLACK
SKU: 5014



MINI STRAIGHT CONNECTOR BLACK
SKU: 5012



T-CONNECTOR BLACK
SKU: 5018



END CAP BLACK
SKU: 5024



L-FEEDER WHITE
SKU: 5019



L-CONNECTOR WHITE
SKU: 5015



X-CONNECTOR WHITE
SKU: 5021



FLEXIBLE CONNECTOR WHITE
SKU: 5025



L-FEEDER BLACK
SKU: 5020



L-CONNECTOR BLACK
SKU: 5016



X-CONNECTOR BLACK
SKU: 5022



FLEXIBLE CONNECTOR BLACK
SKU: 5026

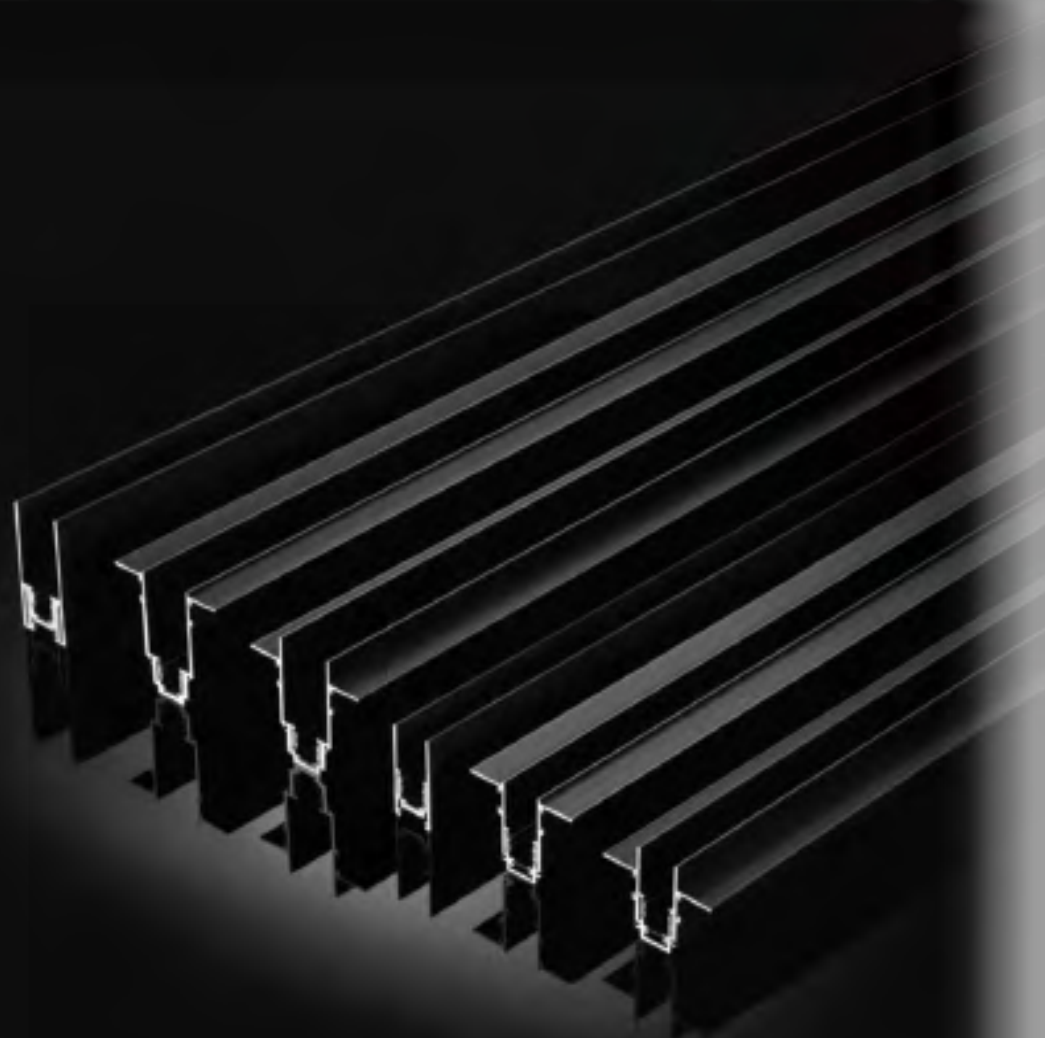

NEW

MAGNETIC TRACK SERIES

Magnetic force connects profile and modules both mechanical and electrical.

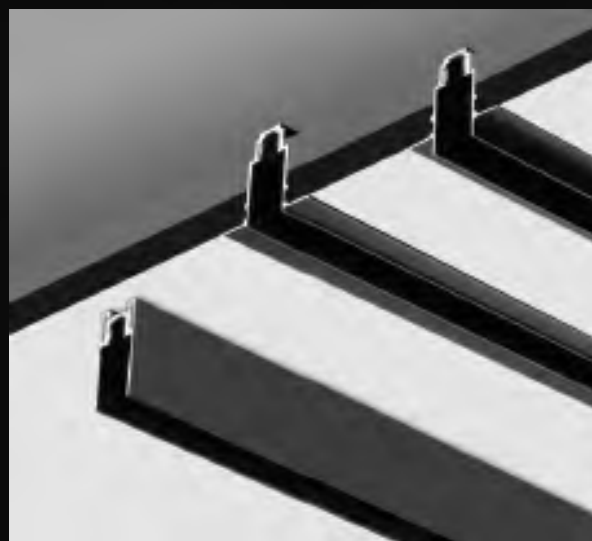

TRACK SYSTEM 3 PHASES R35

- SKU: 5350 BLACK BODY - 1m 3800156653504
- SKU: 5351 BLACK BODY - 1.5m 3800156653511
- SKU: 5352 BLACK BODY - 2m 3800156653528



ANGLE CONNECTOR
SKU: 5358 3800156653580



END CAP
SKU: 5353 3800156653535

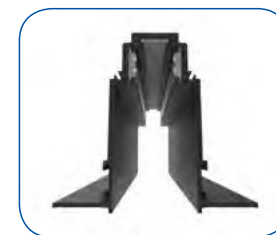

TRACK SYSTEM 3 PHASES R35 Build-in

- SKU: 5360 BLACK BODY - 1m 3800156653603
- SKU: 5361 BLACK BODY - 1.5m 3800156653610
- SKU: 5362 BLACK BODY - 2m 3800156653627



ANGLE CONNECTOR
SKU: 5363 3800156653634



END CAP
SKU: 5411 3800156654112

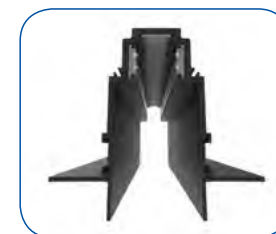

TRACK SYSTEM 3 PHASES R35B-Build-in

- SKU: 5420 BLACK BODY - 1m 3800156654204
- SKU: 5421 BLACK BODY - 1.5m 3800156654211
- SKU: 5422 BLACK BODY - 2m 3800156654228



ANGLE CONNECTOR
SKU: 5423 3800156654235



END CAP
SKU: 5411 3800156654112



TRACK SYSTEM 3 PHASES S20

- SKU: 5364 BLACK BODY - 1m 3800156653641
- SKU: 5365 BLACK BODY - 1.5m 3800156653658
- SKU: 5366 BLACK BODY - 2m 3800156653665



ANGLE CONNECTOR
SKU: 5412 3800156654129



END CAP
SKU: 5413 3800156654136



TRACK SYSTEM 3 PHASES R20 Build-in

- SKU: 5367 BLACK BODY - 1m 3800156653672
- SKU: 5368 BLACK BODY - 1.5m 3800156653689
- SKU: 5369 BLACK BODY - 2m 3800156653696



ANGLE CONNECTOR
SKU: 5414 3800156654143



END CAP
SKU: 5415 3800156654150

NEW



TRACK SYSTEM 3 PHASES R20B-Build-in

- SKU: 5450 BLACK BODY - 1m 3800156654501
- SKU: 5451 BLACK BODY - 1.5m 3800156654518
- SKU: 5452 BLACK BODY - 2m 3800156654525



ANGLE CONNECTOR
SKU: 5453 3800156654532



END CAP
SKU: 5415 3800156654150



**LED Magnetic Track Light
12W ; 20W**

Product code	LN12-A4 ; LN20-A4	CRI	Ra>80
Power	12W ; 20W	IP Rating	IP20
Beam Angle	120°	Dimension 12W	300x34x50mm
Voltage	DC:48V	Dimension 20W	600x34x50mm



SKU: 5340	12W 30cm	3000K	3800156653405
SKU: 5391	12W 30cm	4000K	3800156653917
SKU: 5341	20W 60cm	3000K	3800156653412
SKU: 5392	20W 60cm	4000K	3800156653924



**LED Magnetic Track Light
10W ; 20W**

Product code	LN10-A4 ; LN20-A4	CRI	Ra>80
Power	10W ; 20W	IP Rating	IP20
Beam Angle	24°	Dimension 10W	135x34x95mm
Voltage	DC:48V	Dimension 20W	270x34x95mm



SKU: 5347	10W 13.5cm	3000K	3800156653474
SKU: 5398	10W 13.5cm	4000K	3800156653986
SKU: 5348	20W 27cm	3000K	3800156653481
SKU: 5399	20W 27cm	4000K	3800156653993



**LED Magnetic Track Light
10W ; 20W**

Product code	LN10-A4 ; LN20-A4	CRI	Ra>80
Power	10W ; 20W	IP Rating	IP20
Beam Angle	24°	Dimension 10W	135x34x50mm
Voltage	DC:48V	Dimension 18W	270x34x50mm



SKU: 5342	10W 13.5cm	3000K	3800156653429
SKU: 5393	10W 13.5cm	4000K	3800156653931
SKU: 5343	20W 27cm	3000K	3800156653436
SKU: 5394	20W 27cm	4000K	3800156653948



**LED Magnetic Track Light
7W Focusing Spot Light**

Product code	LN7-A4	Beam Angle	15-60°
Watts	7W	CRI	Ra>90
Input Voltage	48V	IP Rating	IP20
Flux	560lm	Dimension	Φ60x200mm



SKU: 5349	Warm White	3000K	3800156653498
SKU: 5400	Neutral White	4000K	3800156654006

LED Magnetic Track Light
7W



Product code	LN7-A4	CRI	Ra>90
Watts	7W	IP Rating	IP20
Input Voltage	48V	Dimension	Φ55x105mm
Flux	560lm	Body Color	Black
Beam Angle	15°		

SKU: 5344 Warm White 3000K 3800156653443
 SKU: 5395 Neutral White 4000K 3800156653955

LED Magnetic Track Light
12W



Product code	LN12-A4	CRI	Ra>90
Watts	12W	IP Rating	IP20
Input Voltage	48V	Dimension	Φ65x130mm
Flux	960lm	Body Color	Black
Beam Angle	15°		

SKU: 5345 Warm White 3000K 3800156653450
 SKU: 5396 Neutral White 4000K 3800156653962

LED Magnetic Track Light
20W



Product code	LN20-A4	CRI	Ra>90
Watts	20W	IP Rating	IP20
Input Voltage	48V	Dimension	Φ65x130mm
Flux	1600lm	Body Color	Black
Beam Angle	15°		

SKU: 5346 Warm White 3000K 3800156653467
 SKU: 5397 Neutral White 4000K 3800156653979

Power Supplies for Track Light
BUILT-IN 48V Output



SKU: 5424 AC100-B2 100W - 48V 3800156654242
 SKU: 5425 AC200-B2 200W - 48V 3800156654259
 SKU: 5426 AC100-B2 100W - 48V 3800156654266
 SKU: 5427 AC200-B2 200W - 48V 3800156654273
 SKU: 5428 AC280-B2 280W - 48V 3800156654280

Watts	100W	200W	100W	200W	280W
Input Voltage	220V	220V	220V	220V	220V
Output Voltage	DC: 48V	DC: 48V	DC: 48V	DC: 48V	DC: 48V
Current	2.1A	4.2A	2.1A	4.2A	5.85A
Material	PC	PC	PC	PC	PC
IP Rating	IP20	IP20	IP20	IP20	IP20
Dimension	190x90x30mm	220x120x30mm	220x120x30mm	220x120x30mm	220x120x30mm





800 Lumens



1440 Lumens

**LED Magnetic Track Light - M20
10W ; 18W**



Product code	LN10-A4 ; LN18-A4	CRI	Ra>80
Power	10W ;18W	IP Rating	IP20
Beam Angle	120°	Dimension 10W	300x22x25mm
Voltage	DC:48V	Dimension 18W	600x22x25mm

SKU: 5417	10W 30cm	3000K	3800156653085
SKU: 5416	10W 30cm	4000K	3800156653078
SKU: 5419	18W 60cm	3000K	3800156653108
SKU: 5418	18W 60cm	4000K	3800156653092



480 Lumens



960 Lumens

**LED Magnetic Track Light - M20
6W ; 12W**



Product code	LN6-A4 ; LN12-A4	CRI	Ra>80
Power	6W ;12W	IP Rating	IP20
Beam Angle	24°	Dimension 10W	112x22x45mm
Voltage	DC:48V	Dimension 18W	220x22x45mm

SKU: 5312	6W	3000K	3800156653122
SKU: 5311	6W	4000K	3800156653115
SKU: 5314	12W	3000K	3800156653146
SKU: 5313	12W	4000K	3800156653139



CRI 90+

**LED Magnetic Track Light
12W**



Product code	LN12-A5	CRI	Ra>90
Watts	12W	IP Rating	IP20
Input Voltage	48V	Dimension	Φ65x130mm
Flux	960lm	Body Color	Black
Beam Angle	15°		

SKU: 5316	Warm White	3000K	3800156653160
SKU: 5315	Neutral White	4000K	3800156653153



CRI 90+

**LED Magnetic Track Light
10W**



Product code	LN10-A5	CRI	Ra>90
Watts	10W	IP Rating	IP20
Input Voltage	48V	Dimension	Φ70x100mm
Flux	800lm	Body Color	Black
Beam Angle	15-24°		

SKU: 5379	Warm White	3000K	3800156653795
SKU: 5378	Neutral White	4000K	3800156653788



Straight Joint

SKU: 5356



Joining Cable

SKU: 5357



Input Cable

SKU: 5355



Hanging Accessories

SKU: 5354

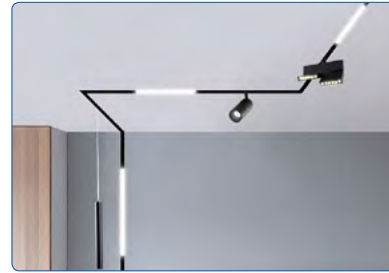

LED Magnetic Track Light 9W



Product code LN9-A4
 Power 9W
 Beam Angle 24°
 Voltage DC:48V

CRI Ra>80
 IP Rating IP20
 Dimension 137x34x95mm

SKU: 5318 Warm White 3000K 3800156653184
 SKU: 5317 Neutral White 4000K 3800156653177



LED Magnetic Track Light 5W



Product code LN5-A4
 Power 5W
 Beam Angle 15-60°
 Voltage DC:48V

CRI Ra>80
 IP Rating IP20
 Dimension Φ60*200mm

SKU: 5319 Warm White 3000K 3800156653191
 SKU: 5320 Neutral White 4000K 3800156653207



LED Magnetic Track Light 6W



Product code LN6-A5
 Watts 6W
 Input Voltage 48V
 Flux 480lm
 Beam Angle 90°

CRI Ra>80
 IP Rating IP20
 Dimension ø130mm
 Body Color Black

SKU: 5335 Neutral White 4000K 3800156653351
 SKU: 5334 Warm White 3000K 3800156653344



LED Magnetic Track Light 10W



Product code LN10-A5
 Watts 10W
 Input Voltage 48V
 Flux 800lm
 Beam Angle 90°

CRI Ra>80
 IP Rating IP20
 Dimension ø85mm
 Body Color Black

SKU: 5337 Neutral White 4000K 3800156653375
 SKU: 5336 Warm White 3000K 3800156653368



LED Magnetic Track Light 5W



Product code LN5-A5
 Watts 5W
 Input Voltage 48V
 Flux 400lm
 Beam Angle 50°

CRI Ra>80
 IP Rating IP20
 Dimension 88x75mm
 Body Color Black

SKU: 5339 Neutral White 4000K 3800156653399
 SKU: 5338 Warm White 3000K 3800156653382



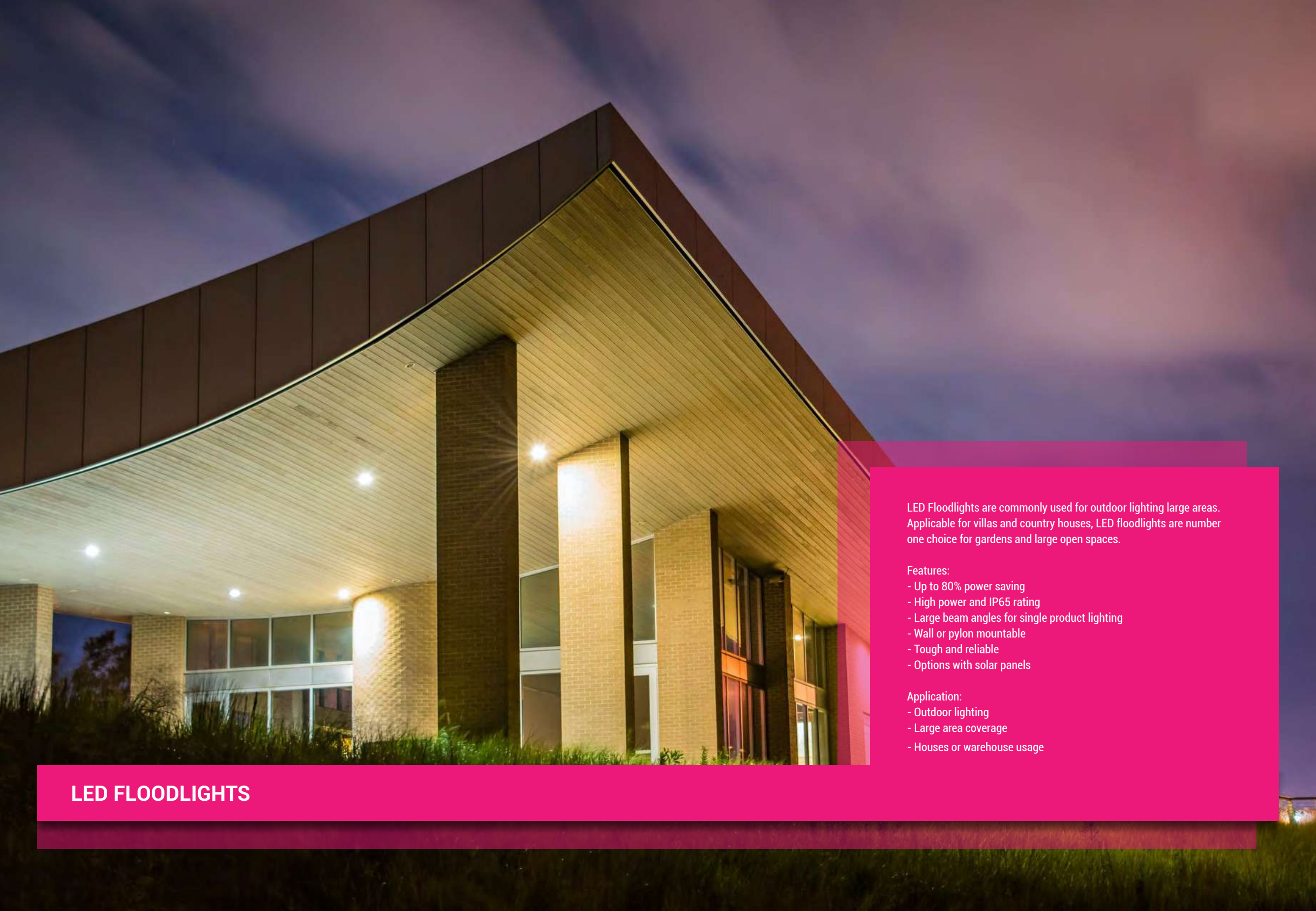

LED FLOODLIGHTS

LED Floodlights are commonly used for outdoor lighting large areas. Applicable for villas and country houses, LED floodlights are number one choice for gardens and large open spaces.

Features:

- Up to 80% power saving
- High power and IP65 rating
- Large beam angles for single product lighting
- Wall or pylon mountable
- Tough and reliable
- Options with solar panels

Application:

- Outdoor lighting
- Large area coverage
- Houses or warehouse usage



LED SMD FLOODLIGHT PF>0.9
With Solar Panels and Remote Control



	Product code	FL6-B5	Beam Angle	90°		SKU: 5455 White Light ■ 6000K 3800156654556
	EQ.Watts	6W	CRI	Ra>80		
	Battery	3.2V / 5Ah	IP Rating	IP65		
	Flux	400lm	Body Color	Grey		
	Product code	FL8-B5	Beam Angle	90°		SKU: 5456 White Light ■ 6000K 3800156654563
	EQ.Watts	8W	CRI	Ra>80		
	Battery	3.2V / 6Ah	IP Rating	IP65		
	Flux	500lm	Body Color	Grey		
	Product code	FL15-B5	Beam Angle	90°		SKU: 5457 White Light ■ 6000K 3800156654570
	EQ.Watts	15W	CRI	Ra>80		
	Battery	3.2V / 10Ah	IP Rating	IP65		
	Flux	1200lm	Body Color	Grey		
	Product code	FL20-B5	Beam Angle	90°		SKU: 5458 White Light ■ 6000K 3800156654587
	EQ.Watts	20W	CRI	Ra>80		
	Battery	3.2V / 20Ah	IP Rating	IP65		
	Flux	1800lm	Body Color	Grey		
	Product code	FL30-B5	Beam Angle	90°		SKU: 5459 White Light ■ 6000K 3800156654594
	EQ.Watts	30W	CRI	Ra>80		
	Battery	3.2V / 25Ah	IP Rating	IP65		
	Flux	2400lm	Body Color	Grey		



LED SMD FLOODLIGHT PF>0.9
With Solar Panels and Remote Control



	Product code	FL12-A6	Beam Angle	120°		SKU: 5465 White Light ■ 6000K 3800156654655
	EQ.Watts	50W	CRI	Ra>80		
	Battery	3.2V / 11Ah	IP Rating	IP65		
	Flux	900lm	Body Color	Black		
	Product code	FL35-A6	Beam Angle	120°		SKU: 5466 White Light ■ 6000K 3800156654662
	EQ.Watts	100W	CRI	Ra>80		
	Battery	6.4V / 16.5Ah	IP Rating	IP65		
	Flux	2500lm	Body Color	Black		
	Product code	FL40-A6	Beam Angle	120°		SKU: 5467 White Light ■ 6000K 3800156654679
	EQ.Watts	150W	CRI	Ra>80		
	Battery	6.4V / 22Ah	IP Rating	IP65		
	Flux	3200lm	Body Color	Black		



LED SMD FLOODLIGHT PF>0.9
With Solar Panels and Remote Control



	Product code	FL25-A6	Beam Angle	120°		SKU: 5460 White Light ■ 6000K 3800156654600
	EQ.Watts	12W	CRI	Ra>80		
	Battery	3.2V / 5.5Ah	IP Rating	IP65		
	Flux	800lm	Body Color	Black		

	Product code	FL40-A6	Beam Angle	120°		SKU: 5461 White Light ■ 6000K 3800156654617
	EQ.Watts	40W	CRI	Ra>80		
	Battery	3.2V / 11Ah	IP Rating	IP65		
	Flux	1300lm	Body Color	Black		

	Product code	FL60-B2	Beam Angle	120°		SKU: 5462 White Light ■ 6000K 3800156654624
	EQ.Watts	20W	CRI	Ra>80		
	Battery	6.4V / 11Ah	IP Rating	IP65		
	Flux	1800lm	Body Color	Black		

	Product code	FL100-B2	Beam Angle	120°		SKU: 5463 White Light ■ 6000K 3800156654631
	EQ.Watts	35W	CRI	Ra>80		
	Battery	6.4V / 16.5Ah	IP Rating	IP65		
	Flux	2500lm	Body Color	Black		



LED SMD FLOODLIGHT
High Power - Black Body

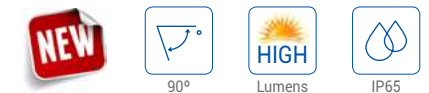

	Product code	FL150-B3	Beam Angle	90°		SKU: 5736 White Light ■ 6000K 3800156657366 SKU: 5737 Neutral White ■ 4500K 3800156657373
	Watts	150W	CRI	Ra>80		
	Input Voltage	AC : 220-240V	IP Rating	IP65		
	Flux	13500lm	Body Color	Black		

	Product code	FL200-B3	Beam Angle	90°		SKU: 5738 White Light ■ 6000K 3800156657380 SKU: 5739 Neutral White ■ 4500K 3800156657397
	Watts	200W	CRI	Ra>80		
	Input Voltage	AC : 220-240V	IP Rating	IP65		
	Flux	18000lm	Body Color	Black		





LED SMD FLOODLIGHT
White Body

LED SMD FLOODLIGHT
Black Body



10W	Product code	FL10-B3	Beam Angle	90°
900 Lumens	Watts	10W	CRI	Ra>80
	Input Voltage	AC : 220-240V	IP Rating	IP65
	Flux	900lm	Body Color	White

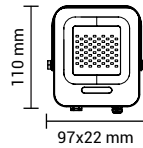

SKU: 5701	White Light	6000K	3800156657014
SKU: 5702	Neutral White	4500K	3800156657021
SKU: 5703	Warm White	2700K	3800156657038

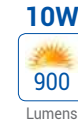

10W	Product code	FL10-B3	Beam Angle	90°
900 Lumens	Watts	10W	CRI	Ra>80
	Input Voltage	AC : 220-240V	IP Rating	IP65
	Flux	900lm	Body Color	Black

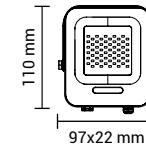

SKU: 5721	White Light	6000K	3800156657212
SKU: 5722	Neutral White	4500K	3800156657229
SKU: 5723	Warm White	2700K	3800156657236



20W	Product code	FL20-B3	Beam Angle	90°
1800 Lumens	Watts	20W	CRI	Ra>80
	Product code	AC : 220-240V	IP Rating	IP65
	Flux	1800lm	Body Color	White

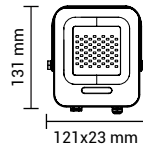

SKU: 5704	White Light	6000K	3800156657045
SKU: 5705	Neutral White	4500K	3800156657052
SKU: 5706	Warm White	2700K	3800156657069



20W	Product code	FL20-B3	Beam Angle	90°
1800 Lumens	Watts	20W	CRI	Ra>80
	Product code	AC : 220-240V	IP Rating	IP65
	Flux	1800lm	Body Color	Black

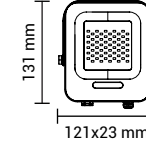

SKU: 5724	White Light	6000K	3800156657243
SKU: 5725	Neutral White	4500K	3800156657250
SKU: 5726	Warm White	2700K	3800156657267



30W	Product code	FL30-B3	Beam Angle	90°
2700 Lumens	Watts	30W	CRI	Ra>80
	Input Voltage	AC : 220-240V	IP Rating	IP65
	Flux	2700lm	Body Color	White

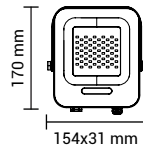

SKU: 5707	White Light	6000K	3800156657076
SKU: 5708	Neutral White	4500K	3800156657083
SKU: 5709	Warm White	2700K	3800156657090

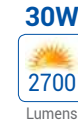

30W	Product code	FL30-B3	Beam Angle	90°
2700 Lumens	Watts	30W	CRI	Ra>80
	Input Voltage	AC : 220-240V	IP Rating	IP65
	Flux	2700lm	Body Color	Black

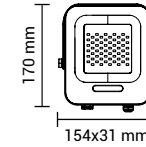

SKU: 5727	White Light	6000K	3800156657274
SKU: 5728	Neutral White	4500K	3800156657281
SKU: 5729	Warm White	2700K	3800156657298



50W	Product code	FL50-B3	Beam Angle	90°
4500 Lumens	Watts	50W	CRI	Ra>80
	Input Voltage	AC : 220-240V	IP Rating	IP65
	Flux	4500lm	Body Color	White

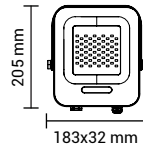

SKU: 5710	White Light	6000K	3800156657106
SKU: 5711	Neutral White	4500K	3800156657113
SKU: 5712	Warm White	2700K	3800156657120



50W	Product code	FL50-B3	Beam Angle	90°
4500 Lumens	Watts	50W	CRI	Ra>80
	Input Voltage	AC : 220-240V	IP Rating	IP65
	Flux	4500lm	Body Color	Black

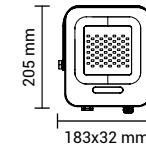

SKU: 5730	White Light	6000K	3800156657304
SKU: 5731	Neutral White	4500K	3800156657311
SKU: 5732	Warm White	2700K	3800156657328



100W	Product code	FL100-B3	Beam Angle	90°
9000 Lumens	Watts	100W	CRI	Ra>80
	Input Voltage	AC : 220-240V	IP Rating	IP65
	Flux	9000lm	Body Color	White

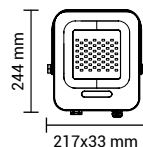

SKU: 5713	White Light	6000K	3800156657137
SKU: 5714	Neutral White	4500K	3800156657144
SKU: 5715	Warm White	2700K	3800156657151



100W	Product code	FL100-B3	Beam Angle	90°
9000 Lumens	Watts	100W	CRI	Ra>80
	Input Voltage	AC : 220-240V	IP Rating	IP65
	Flux	9000lm	Body Color	Black

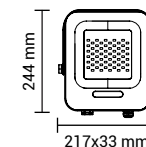

SKU: 5733	White Light	6000K	3800156657335
SKU: 5734	Neutral White	4500K	3800156657342
SKU: 5735	Warm White	2700K	3800156657359

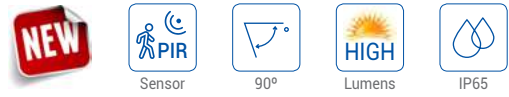

LED SMD FLOODLIGHT
White Body - PIR Sensor



10W	Product code	FL10-B3	Beam Angle	90°
	Watts	10W	CRI	Ra>80
	Input Voltage	AC : 220-240V	IP Rating	IP65
	Flux	900lm	Body Color	White

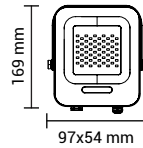

SKU: 5760	White Light	6000K	3800156657601
SKU: 5761	Neutral White	4500K	3800156657618
SKU: 5762	Warm White	2700K	3800156657625



20W	Product code	FL20-B3	Beam Angle	90°
	Watts	20W	CRI	Ra>80
	Input Voltage	AC : 220-240V	IP Rating	IP65
	Flux	1800lm	Body Color	White

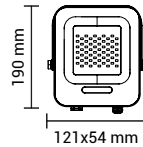

SKU: 5763	White Light	6000K	3800156657632
SKU: 5764	Neutral White	4500K	3800156657649
SKU: 5765	Warm White	2700K	3800156657656



30W	Product code	FL30-B3	Beam Angle	90°
	Watts	30W	CRI	Ra>80
	Input Voltage	AC : 220-240V	IP Rating	IP65
	Flux	2700lm	Body Color	White

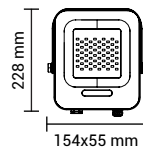

SKU: 5766	White Light	6000K	3800156657663
SKU: 5767	Neutral White	4500K	3800156657670
SKU: 5768	Warm White	2700K	3800156657687



50W	Product code	FL50-B3	Beam Angle	90°
	Watts	50W	CRI	Ra>80
	Input Voltage	AC : 220-240V	IP Rating	IP65
	Flux	4500lm	Body Color	White

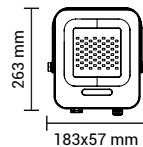

SKU: 5769	White Light	6000K	3800156657694
SKU: 5770	Neutral White	4500K	3800156657700

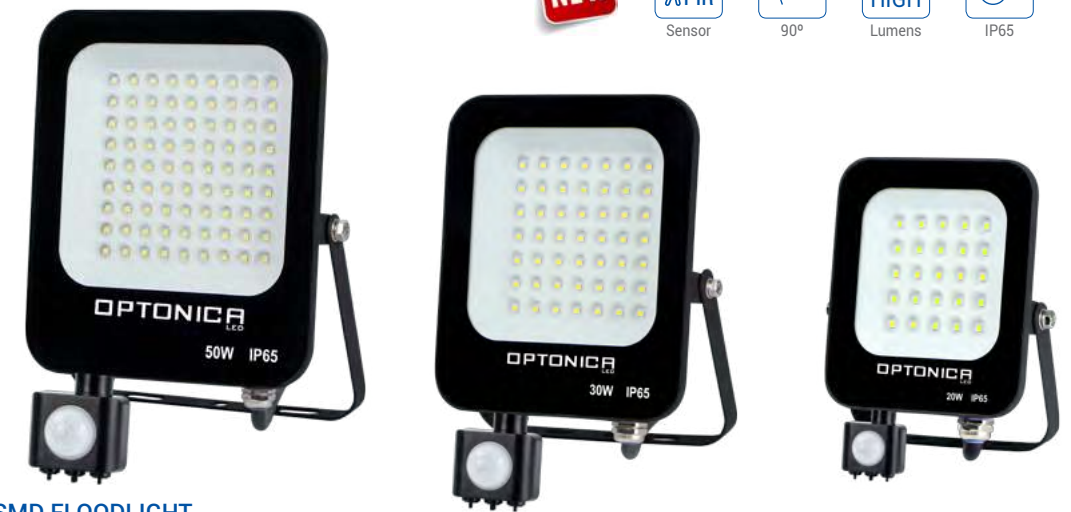

LED SMD FLOODLIGHT
Black Body - PIR Sensor



10W	Product code	FL10-B3	Beam Angle	90°
	Watts	10W	CRI	Ra>80
	Input Voltage	AC : 220-240V	IP Rating	IP65
	Flux	900lm	Body Color	Black

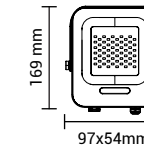

SKU: 5771	White Light	6000K	3800156657717
SKU: 5772	Neutral White	4500K	3800156657724
SKU: 5773	Warm White	2700K	3800156657731



20W	Product code	FL20-B3	Beam Angle	90°
	Watts	20W	CRI	Ra>80
	Input Voltage	AC : 220-240V	IP Rating	IP65
	Flux	1800lm	Body Color	Black

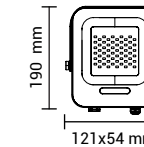

SKU: 5774	White Light	6000K	3800156657748
SKU: 5775	Neutral White	4500K	3800156657755
SKU: 5776	Warm White	2700K	3800156657762



30W	Product code	FL30-B3	Beam Angle	90°
	Watts	30W	CRI	Ra>80
	Input Voltage	AC : 220-240V	IP Rating	IP65
	Flux	2700lm	Body Color	Black

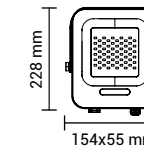

SKU: 5777	White Light	6000K	3800156657779
SKU: 5778	Neutral White	4500K	3800156657786
SKU: 5779	Warm White	2700K	3800156657793



50W	Product code	FL50-B3	Beam Angle	90°
	Watts	50W	CRI	Ra>80
	Input Voltage	AC : 220-240V	IP Rating	IP65
	Flux	4500lm	Body Color	Black

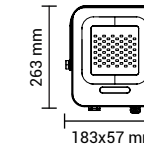

SKU: 5780	White Light	6000K	3800156657809
SKU: 5781	Neutral White	4500K	3800156657816



LED SMD FLOODLIGHT PF>0.9
High Power - Grey Body



100W 10000 Lumens	Product code	FL100-B4	Beam Angle	90°
	Watts	100W	CRI	Ra>80
	Input Voltage	AC : 220-240V	IP Rating	IP65
	Flux	10000lm	Body Color	Grey

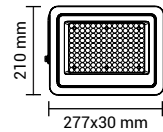

SKU: 5741 White Light 6000K 3800156657410
 SKU: 5742 Neutral White 4500K 3800156657427

150W 15000 Lumens	Product code	FL150-B4	Beam Angle	90°
	Watts	150W	CRI	Ra>80
	Input Voltage	AC : 220-240V	IP Rating	IP65
	Flux	15000lm	Body Color	Grey

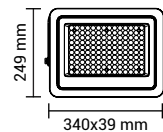

SKU: 5743 White Light 6000K 3800156657434
 SKU: 5744 Neutral White 4500K 3800156657441

200W 20000 Lumens	Product code	FL200-B4	Beam Angle	90°
	Watts	200W	CRI	Ra>80
	Input Voltage	AC : 220-240V	IP Rating	IP65
	Flux	20000lm	Body Color	Grey

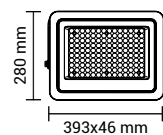

SKU: 5745 White Light 6000K 3800156657458
 SKU: 5746 Neutral White 4500K 3800156657465



LED SMD FLOODLIGHT PF>0.9
High Power - Grey Body



300W 36000 Lumens	Product code	FL150-A5	Beam Angle	90°
	Watts	300W	CRI	Ra>80
	Input Voltage	AC :220-240V	IP Rating	IP65
	Flux	36000lm	Body Color	Grey

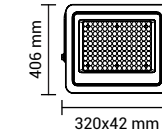

SKU: 5747 White Light 6000K 3800156657472
 SKU: 5748 Neutral White 4500K 3800156657489

400W 48000 Lumens	Product code	FL200-A5	Beam Angle	90°
	Watts	400W	CRI	Ra>80
	Input Voltage	AC :220-240V	IP Rating	IP65
	Flux	48000lm	Body Color	Grey

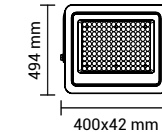

SKU: 5749 White Light 6000K 3800156657496
 SKU: 5750 Neutral White 4500K 3800156657502





5 Years Warranty
HIGH Lumens
IP65



Power Cable Length-0.70m

LED SMD FLOODLIGHT PF>0.9
Premium Line - White Body

10W 850 Lumens	Product code	FL10-A5	Beam Angle	150°
	Watts	10W	CRI	Ra>80
	Input Voltage	AC : 175-265V	IP Rating	IP65
	Flux	850lm	Body Color	White

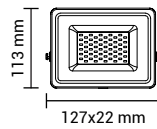

SKU: 5865	White Light	6000K	3800156658653
SKU: 5866	Neutral White	4500K	3800156658660
SKU: 5867	Warm White	2800K	3800156658677

20W 1700 Lumens	Product code	FL20-A5	Beam Angle	150°
	Watts	20W	CRI	Ra>80
	Input Voltage	AC : 175-265V	IP Rating	IP65
	Flux	1700lm	Body Color	White

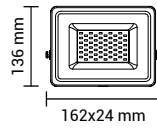

SKU: 5868	White Light	6000K	3800156658684
SKU: 5869	Neutral White	4500K	3800156658691
SKU: 5870	Warm White	2800K	3800156658707

30W 2550 Lumens	Product code	FL30-A5	Beam Angle	150°
	Watts	30W	CRI	Ra>80
	Input Voltage	AC : 175-265V	IP Rating	IP65
	Flux	2550lm	Body Color	White

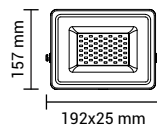

SKU: 5871	White Light	6000K	3800156658714
SKU: 5872	Neutral White	4500K	3800156658721
SKU: 5873	Warm White	2800K	3800156658738

50W 4250 Lumens	Product code	FL50-A5	Beam Angle	150°
	Watts	50W	CRI	Ra>80
	Input Voltage	AC : 175-265V	IP Rating	IP65
	Flux	4250lm	Body Color	White

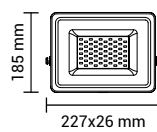

SKU: 5874	White Light	6000K	3800156658745
SKU: 5875	Neutral White	4500K	3800156658752
SKU: 5876	Warm White	2800K	3800156658769

100W 8500 Lumens	Product code	FL100-A5	Beam Angle	150°
	Watts	100W	CRI	Ra>80
	Input Voltage	AC : 175-265V	IP Rating	IP65
	Flux	8500lm	Body Color	White

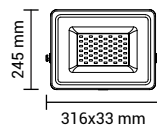

SKU: 5877	White Light	6000K	3800156658776
SKU: 5878	Neutral White	4500K	3800156658783
SKU: 5879	Warm White	2800K	3800156658790



5 Years Warranty
HIGH Lumens
IP65



Power Cable Length-0.70m

LED SMD FLOODLIGHT PF>0.9
Premium Line - Black Body

10W 850 Lumens	Product code	FL10-A5	Beam Angle	150°
	Watts	10W	CRI	Ra>80
	Input Voltage	AC : 175-265V	IP Rating	IP65
	Flux	850lm	Body Color	Black

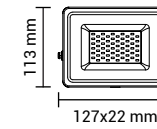

SKU: 5880	White Light	6000K	3800156658806
SKU: 5881	Neutral White	4500K	3800156658813
SKU: 5882	Warm White	2800K	3800156658820

20W 1700 Lumens	Product code	FL20-A5	Beam Angle	150°
	Watts	20W	CRI	Ra>80
	Input Voltage	AC : 175-265V	IP Rating	IP65
	Flux	1700lm	Body Color	Black

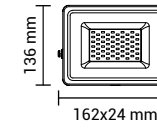

SKU: 5883	White Light	6000K	3800156658837
SKU: 5884	Neutral White	4500K	3800156658844
SKU: 5885	Warm White	2800K	3800156658851

30W 2550 Lumens	Product code	FL30-A5	Beam Angle	150°
	Watts	30W	CRI	Ra>80
	Input Voltage	AC : 175-265V	IP Rating	IP65
	Flux	2550lm	Body Color	Black

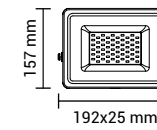

SKU: 5886	White Light	6000K	3800156658868
SKU: 5887	Neutral White	4500K	3800156658875
SKU: 5888	Warm White	2800K	3800156658882

50W 4250 Lumens	Product code	FL50-A5	Beam Angle	150°
	Watts	50W	CRI	Ra>80
	Input Voltage	AC : 175-265V	IP Rating	IP65
	Flux	4250lm	Body Color	Black

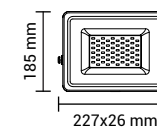

SKU: 5889	White Light	6000K	3800156658899
SKU: 5890	Neutral White	4500K	3800156658906
SKU: 5891	Warm White	2800K	3800156658912

100W 8500 Lumens	Product code	FL100-A5	Beam Angle	150°
	Watts	100W	CRI	Ra>80
	Input Voltage	AC : 175-265V	IP Rating	IP65
	Flux	8500lm	Body Color	Black

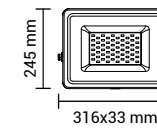

SKU: 5892	White Light	6000K	3800156658929
SKU: 5893	Neutral White	4500K	3800156658936
SKU: 5894	Warm White	2800K	3800156658943



LED SMD FLOODLIGHT PF>0.9
Premium Line - White Body



Power Cable Length-1.00m

150W 	Product code	FL150-A5	Beam Angle	150°
	Watts	150W	CRI	Ra>80
	Input Voltage	AC : 100-265V	IP Rating	IP65
	Flux	18000lm	Body Color	White

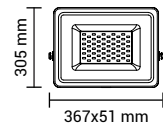

SKU: 5786 White Light 6000K 3800156657861
SKU: 5787 Neutral White 4500K 3800156657878

200W 	Product code	FL200-A5	Beam Angle	150°
	Watts	200W	CRI	Ra>80
	Input Voltage	AC : 100-265V	IP Rating	IP65
	Flux	24000lm	Body Color	White

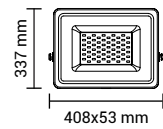

SKU: 5788 White Light 6000K 3800156657885
SKU: 5789 Neutral White 4500K 3800156657892

300W 	Product code	FL300-A5	Beam Angle	150°
	Watts	300W	CRI	Ra>80
	Input Voltage	AC : 100-265V	IP Rating	IP65
	Flux	36000lm	Body Color	White

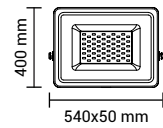

SKU: 5790 White Light 6000K 3800156657908
SKU: 5791 Neutral White 4500K 3800156657915

LED SMD FLOODLIGHT PF>0.9
Premium Line - Black Body



Power Cable Length-1.00m

150W 	Product code	FL150-A5	Beam Angle	150°
	Watts	150W	CRI	Ra>80
	Input Voltage	AC : 100-265V	IP Rating	IP65
	Flux	18000lm	Body Color	Black

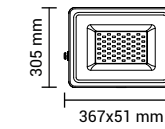

SKU: 5792 White Light 6000K 3800156657922
SKU: 5793 Neutral White 4500K 3800156657939

200W 	Product code	FL200-A5	Beam Angle	150°
	Watts	200W	CRI	Ra>80
	Input Voltage	AC : 100-265V	IP Rating	IP65
	Flux	24000lm	Body Color	Black

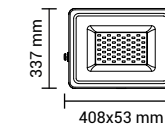

SKU: 5794 White Light 6000K 3800156657946
SKU: 5795 Neutral White 4500K 3800156657953

300W 	Product code	FL300-A5	Beam Angle	150°
	Watts	300W	CRI	Ra>80
	Input Voltage	AC : 100-265V	IP Rating	IP65
	Flux	36000lm	Body Color	Black

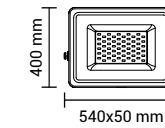

SKU: 5796 White Light 6000K 3800156657960
SKU: 5797 Neutral White 4500K 3800156657977



**LED SMD FLOODLIGHT
CITY LINE - White Body**

10W 800 Lumens	Product code	FL10-B1	Beam Angle	120°	 108x24 mm	SKU: 5900	White Light	6000K	3800156659001
	Watts	10W	CRI	Ra>80		SKU: 5901	Neutral White	4500K	3800156659018
	Input Voltage	AC : 220-265V	IP Rating	IP65		SKU: 5902	Warm White	2800K	3800156659025
	Flux	800lm	Body Color	White					

20W 1600 Lumens	Product code	FL20-B1	Beam Angle	120°	 143x24 mm	SKU: 5903	White Light	6000K	3800156659032
	Watts	20W	CRI	Ra>80		SKU: 5904	Neutral White	4500K	3800156659049
	Input Voltage	AC : 220-265V	IP Rating	IP65		SKU: 5905	Warm White	2800K	3800156659056
	Flux	1600lm	Body Color	White					

30W 2400 Lumens	Product code	FL30-B1	Beam Angle	120°	 187x24 mm	SKU: 5906	White Light	6000K	3800156659063
	Watts	30W	CRI	Ra>80		SKU: 5907	Neutral White	4500K	3800156659070
	Input Voltage	AC : 220-265V	IP Rating	IP65		SKU: 5908	Warm White	2800K	3800156659087
	Flux	2400lm	Body Color	White					

50W 4000 Lumens	Product code	FL50-B1	Beam Angle	120°	 217x26 mm	SKU: 5909	White Light	6000K	3800156659094
	Watts	50W	CRI	Ra>80		SKU: 5910	Neutral White	4500K	3800156659100
	Input Voltage	AC : 220-265V	IP Rating	IP65		SKU: 5911	Warm White	2800K	3800156659117
	Flux	4000lm	Body Color	White					

100W 8000 Lumens	Product code	FL100-B1	Beam Angle	120°	 287x32 mm	SKU: 5912	White Light	6000K	3800156659124
	Watts	100W	CRI	Ra>80		SKU: 5913	Neutral White	4500K	3800156659131
	Input Voltage	AC : 220-265V	IP Rating	IP65		SKU: 5914	Warm White	2800K	3800156659148
	Flux	8000lm	Body Color	White					



**LED SMD FLOODLIGHT
CITY LINE - Black Body**

10W 800 Lumens	Product code	FL10-B1	Beam Angle	120°	 108x24 mm	SKU: 5915	White Light	6000K	3800156659155
	Watts	10W	CRI	Ra>80		SKU: 5916	Neutral White	4500K	3800156659162
	Input Voltage	AC : 220-265V	IP Rating	IP65		SKU: 5917	Warm White	2800K	3800156659179
	Flux	800lm	Body Color	Black					

20W 1600 Lumens	Product code	FL20-B1	Beam Angle	120°	 143x24 mm	SKU: 5918	White Light	6000K	3800156659186
	Watts	20W	CRI	Ra>80		SKU: 5919	Neutral White	4500K	3800156659193
	Input Voltage	AC : 220-265V	IP Rating	IP65		SKU: 5920	Warm White	2800K	3800156659209
	Flux	1600lm	Body Color	Black					

30W 2400 Lumens	Product code	FL30-B1	Beam Angle	120°	 187x24 mm	SKU: 5921	White Light	6000K	3800156659216
	Watts	30W	CRI	Ra>80		SKU: 5922	Neutral White	4500K	3800156659223
	Input Voltage	AC : 220-265V	IP Rating	IP65		SKU: 5923	Warm White	2800K	3800156659230
	Flux	2400lm	Body Color	Black					

50W 4000 Lumens	Product code	FL50-B1	Beam Angle	120°	 217x26 mm	SKU: 5924	White Light	6000K	3800156659247
	Watts	50W	CRI	Ra>80		SKU: 5925	Neutral White	4500K	3800156659254
	Input Voltage	AC : 220-265V	IP Rating	IP65		SKU: 5926	Warm White	2800K	3800156659261
	Flux	4000lm	Body Color	Black					

100W 8000 Lumens	Product code	FL100-B1	Beam Angle	120°	 287x32 mm	SKU: 5927	White Light	6000K	3800156659278
	Watts	100W	CRI	Ra>80		SKU: 5928	Neutral White	4500K	3800156659285
	Input Voltage	AC : 220-265V	IP Rating	IP65		SKU: 5929	Warm White	2800K	3800156659292
	Flux	8000lm	Body Color	Black					



**LED SMD FLOODLIGHT
CITY LINE- White Body
With PIR Sensor**



Product code FL10-B2
Watts 10W
Input Voltage AC : 220-265V
Flux 800lm
Beam Angle 120°
CRI Ra>80
IP Rating IP65
Body Color White

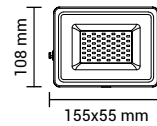

SKU: 5930 White Light 6000K 3800156659308
SKU: 5931 Neutral White 4500K 3800156659315
SKU: 5932 Warm White 2800K 3800156659322



Product code FL20-B2
Watts 20W
Input Voltage AC : 220-265V
Flux 1600lm
Beam Angle 120°
CRI Ra>80
IP Rating IP65
Body Color White

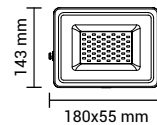

SKU: 5933 White Light 6000K 3800156659339
SKU: 5934 Neutral White 4500K 3800156659346
SKU: 5935 Warm White 2800K 3800156659353



Product code FL30-B2
Watts 30W
Input Voltage AC : 220-265V
Flux 2400lm
Beam Angle 120°
CRI Ra>80
IP Rating IP65
Body Color White

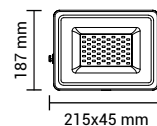

SKU: 5936 White Light 6000K 3800156659360
SKU: 5937 Neutral White 4500K 3800156659377
SKU: 5938 Warm White 2800K 3800156659384



Product code FL50-B2
Watts 50W
Input Voltage AC : 220-265V
Flux 4000lm
Beam Angle 120°
CRI Ra>80
IP Rating IP65
Body Color White

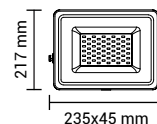

SKU: 5939 White Light 6000K 3800156659391
SKU: 5940 Neutral White 4500K 3800156659407



**LED SMD FLOODLIGHT
CITY LINE - Black Body
With PIR Sensor**



Product code FL10-B2
Watts 10W
Input Voltage AC : 220-265V
Flux 800lm
Beam Angle 120°
CRI Ra>80
IP Rating IP65
Body Color Black

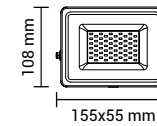

SKU: 5941 White Light 6000K 3800156659308
SKU: 5942 Neutral White 4500K 3800156659315
SKU: 5943 Warm White 2800K 3800156659322



Product code FL20-B2
Watts 20W
Input Voltage AC : 220-265V
Flux 1600lm
Beam Angle 120°
CRI Ra>80
IP Rating IP65
Body Color Black

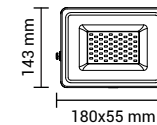

SKU: 5944 White Light 6000K 3800156659339
SKU: 5945 Neutral White 4500K 3800156659346
SKU: 5946 Warm White 2800K 3800156659353



Product code FL30-B2
Watts 30W
Input Voltage AC : 220-265V
Flux 2400lm
Beam Angle 120°
CRI Ra>80
IP Rating IP65
Body Color Black

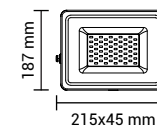

SKU: 5947 White Light 6000K 3800156659360
SKU: 5948 Neutral White 4500K 3800156659377
SKU: 5949 Warm White 2800K 3800156659384



Product code FL50-B2
Watts 50W
Input Voltage AC : 220-265V
Flux 4000lm
Beam Angle 120°
CRI Ra>80
IP Rating IP65
Body Color Black

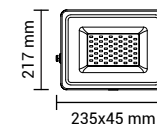

SKU: 5950 White Light 6000K 3800156659391
SKU: 5951 Neutral White 4500K 3800156659407



LED SMD FLOODLIGHT PF>0.9
CCT LIGHT - Black Body



Product code FL50-A7
Watts 50W
Input Voltage AC : 200-277V
Flux 5 000lm

Beam Angle 120°
CRI Ra>80
IP Rating IP66
Body Color Black

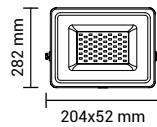

SKU: 5303

6000K CCT 3800156653030
4500K
3000K



Product code FL100-A7
Watts 100W
Input Voltage AC : 200-277V
Flux 10000lm

Beam Angle 120°
CRI Ra>80
IP Rating IP66
Body Color Black

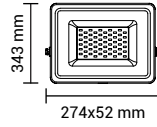

SKU: 5304

6000K CCT 3800156653047
4500K
3000K



Product code FL150-A7
Watts 150W
Input Voltage AC : 200-277V
Flux 15000lm

Beam Angle 120°
CRI Ra>80
IP Rating IP66
Body Color Black

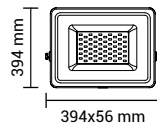

SKU: 5305

6000K CCT 3800156653054
4500K
3000K



Product code FL200-A7
Watts 200W
Input Voltage AC : 200-277V
Flux 20000lm

Beam Angle 120°
CRI Ra>80
IP Rating IP66
Body Color Black

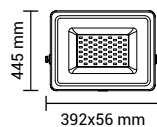

SKU: 5306

6000K CCT 3800156653061
4500K
3000K



LED SMD FLOODLIGHT
CITY LINE - Black Body
With PIR Sensor

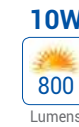
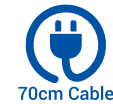

Product code FL10-B2
Watts 10W
Input Voltage AC : 220-265V
Flux 800lm

Beam Angle 120°
CRI Ra>80
IP Rating IP65
Body Color Black

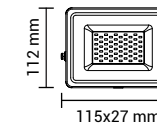

SKU: 5952 White Light 6000K 3800156659520
SKU: 5953 Neutral White 4500K 3800156659537
SKU: 5954 Warm White 2700K 3800156659544



Product code FL20-B2
Watts 20W
Input Voltage AC : 220-265V
Flux 1600lm

Beam Angle 120°
CRI Ra>80
IP Rating IP65
Body Color Black

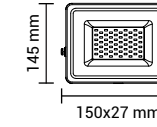

SKU: 5955 White Light 6000K 3800156659551
SKU: 5956 Neutral White 4500K 3800156659568
SKU: 5957 Warm White 2700K 3800156659575



Product code FL30-B2
Watts 30W
Input Voltage AC : 220-265V
Flux 2400lm

Beam Angle 120°
CRI Ra>80
IP Rating IP65
Body Color Black

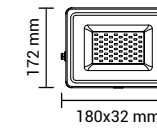

SKU: 5958 White Light 6000K 3800156659582
SKU: 5959 Neutral White 4500K 3800156659599
SKU: 5960 Warm White 2700K 3800156659605

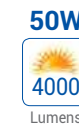

Product code FL50-B2
Watts 50W
Input Voltage AC : 220-265V
Flux 4000lm

Beam Angle 120°
CRI Ra>80
IP Rating IP65
Body Color Black

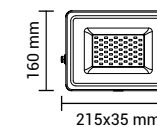

SKU: 5961 White Light 6000K 3800156659612
SKU: 5962 Neutral White 4500K 3800156659629



**LED SMD FLOODLIGHT
On Stand - Foldable**



20W
1600
Lumens

Product code FL20-A8
Watts 20W
Input Voltage AC : 200-240V
Flux 1600lm
Beam Angle 120°
CRI Ra>80
IP Rating IP65
Body Color Yellow

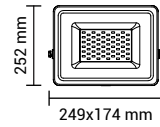

SKU: 5403 White Light 6000K 3800156654037

30W
2400
Lumens

Product code FL30-A8
Watts 30W
Input Voltage AC : 200-240V
Flux 2400lm
Beam Angle 120°
CRI Ra>80
IP Rating IP65
Body Color Yellow

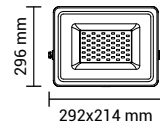

SKU: 5404 White Light 6000K 3800156654044

50W
4000
Lumens

Product code FL50-A8
Watts 50W
Input Voltage AC : 200-240V
Flux 4000lm
Beam Angle 120°
CRI Ra>80
IP Rating IP65
Body Color Yellow

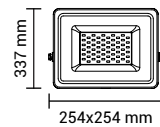

SKU: 5405 White Light 6000K 3800156654051



**PORTABLE LED SMD FLOODLIGHT 10W
Rechargeable + Battery**

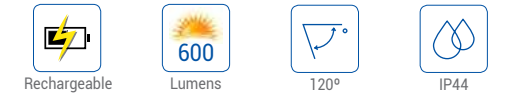

Product code FL10-A8
Watts 10W
Input Voltage AC : 200-240V
Flux 600lm
Beam Angle 120°
CRI Ra>80
IP Rating IP44
Body Color Yellow+Black

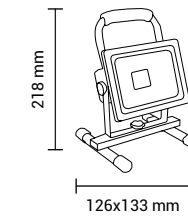

LI-ION
3.7V 2200mAh

1m Cable

SKU: 5401 White Light 6000K 3800156654013

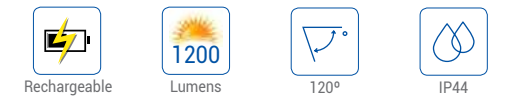

Product code FL20-A8
Watts 20W
Input Voltage AC : 200-240V
Flux 1200lm
Beam Angle 120°
CRI Ra>80
IP Rating IP44
Body Color Yellow+Black

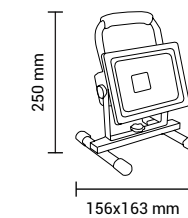

LI-ION
3.7V 4400mAh

1m Cable

SKU: 5402 White Light 6000K 3800156654020

**PORTABLE LED SMD FLOODLIGHT 20W
Rechargeable + Battery**



LED SMD FLOODLIGHT
Black Body -Green Light



Product code FL10-B3
Watts 10W
Input Voltage AC : 220-240V
Flux 800lm
Beam Angle 90°
CRI Ra>70
IP Rating IP65
Body Color Black

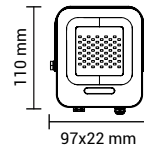

SKU: 5751 Green Light ■ Green 3800156657519



Product code FL20-B3
Watts 20W
Input Voltage AC : 220-240V
Flux 1600lm
Beam Angle 90°
CRI Ra>70
IP Rating IP65
Body Color Black

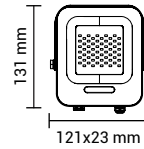

SKU: 5752 Green Light ■ Green 3800156657526



Product code FL30-B3
Watts 30W
Input Voltage AC : 220-240V
Flux 2400lm
Beam Angle 90°
CRI Ra>70
IP Rating IP65
Body Color Black

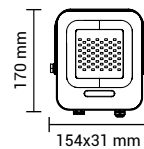

SKU: 5753 Green Light ■ Green 3800156657533



LED RGB SMD FLOODLIGHT
Black Body + Remote Control

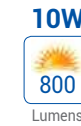

Product code FL10-B4
Watts 10W
Input Voltage AC : 200-240V
Flux 800lm
Beam Angle 120°
CRI Ra>80
IP Rating IP65
Body Color Black

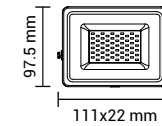

SKU: 5754 RGB ■ ■ ■ 3800156657540



Product code FL30-B4
Watts 30W
Input Voltage AC : 200-240V
Flux 2400lm
Beam Angle 120°
CRI Ra>80
IP Rating IP65
Body Color Black

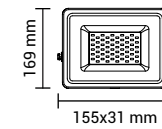

SKU: 5755 RGB ■ ■ ■ 3800156657557

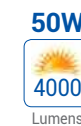

Product code FL50-B4
Watts 50W
Input Voltage AC : 200-240V
Flux 4000lm
Beam Angle 120°
CRI Ra>80
IP Rating IP65
Body Color Black

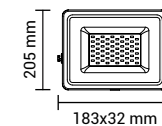

SKU: 5756 RGB ■ ■ ■ 3800156657564



**LED RGB FLOODLIGHT
With Remote Control**

10W 800 Lumens	Product code	FL10-A1	Beam Angle	120°
	Watts	10W	CRI	Ra>80
	Input Voltage	AC : 200-240V	IP Rating	IP66
	Flux	800lm	Body Color	Black

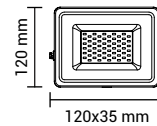

SKU: 5210 RGB 3800156652101

30W 2400 Lumens	Product code	FL30-A1	Beam Angle	120°
	Watts	30W	CRI	Ra>80
	Input Voltage	AC : 200-240V	IP Rating	IP66
	Flux	2400lm	Body Color	Black

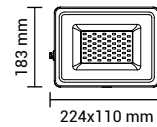

SKU: 5212 RGB 3800156652125

50W 4000 Lumens	Product code	FL50-A1	Beam Angle	120°
	Watts	50W	CRI	Ra>80
	Input Voltage	AC : 200-240V	IP Rating	IP66
	Flux	4000lm	Body Color	Black

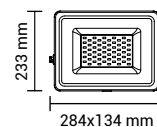

SKU: 5233 RGB 3800156652330



**LED SMD5730 FLOODLIGHT PF>0.9
Dual Voltage With Terminal Block**



100W 9000 Lumens	Product code	FL100-A9	Beam Angle	120°
	Watts	100W	CRI	Ra>80
	Input Voltage	AC : 85-265V	IP Rating	IP65
	Flux	9000lm	Body Color	Black

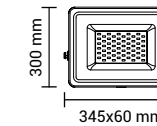

SKU: 5277 White Light 6000K 3800156652774

200W 18000 Lumens	Product code	FL200-A9	Beam Angle	120°
	Watts	200W	CRI	Ra>80
	Input Voltage	AC : 85-265V	IP Rating	IP65
	Flux	18000lm	Body Color	Black

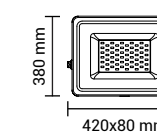

SKU: 5279 White Light 6000K 3800156652798





LED SMD FLOODLIGHT PF>0.9
110V - Yellow Body



Product code	FL80-A7	Beam Angle	120°
Watts	80W	CRI	Ra>80
Input Voltage	AC : 110V-120V	IP Rating	IP65
Flux	6000lm	Body Color	Yellow

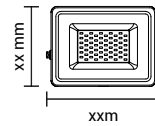

SKU: 5307 6000K 80W 3800156653016



Product code	FL100-A7	Beam Angle	120°
Watts	100W	CRI	Ra>80
Input Voltage	AC : 110V-120V	IP Rating	IP65
Flux	8500lm	Body Color	Yellow

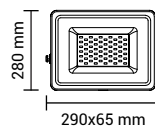

SKU: 5301 6000K 100W 3800156653016



Product code	FL150-A7	Beam Angle	120°
Watts	150W	CRI	Ra>80
Input Voltage	AC : 110V-120V	IP Rating	IP65
Flux	12500lm	Body Color	Yellow

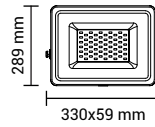

SKU: 5302 6000K 150W 3800156653023



Product code	FL200-A7	Beam Angle	120°
Watts	200W	CRI	Ra>80
Input Voltage	AC : 110V-120V	IP Rating	IP65
Flux	17000lm	Body Color	Yellow

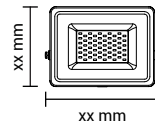

SKU: 5308 6000K 200W 3800156653023



LED SMD FLOODLIGHT
Classic Line 2 - High Power



Product code	FL150-A3	Beam Angle	100°
Watts	100W	CRI	Ra>80
Input Voltage	AC : 170-265V	IP Rating	IP65
Flux	12750lm	Body Color	Black

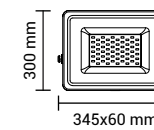

SKU: 5818 White Light 6000K 3800156658189
SKU: 5819 Neutral White 4500K 3800156658196



Product code	FL200-A3	Beam Angle	100°
Watts	200W	CRI	Ra>80
Input Voltage	AC : 170-265V	IP Rating	IP65
Flux	17000lm	Body Color	Black

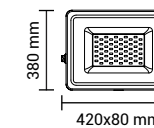

SKU: 5838 White Light 6000K 3800156658387
SKU: 5839 Neutral White 4500K 3800156658394



Floodlight Spike

Body Color	Black
Material	Aluminium

SKU: 6682 160x35cm 3800156666825
SKU: 6683 265x55cm 3800156666832



Billboard Stand

Body Color	Black
Material	Iron

SKU: 6684 150x500cm 3800156666849
SKU: 6685 200x800cm 3800156666856



**TRIPOD FOR FLOODLIGHTS
With Cross Bar**

Product code OT1-B9
 Body Color Yellow , Black
 Material Iron
 Maximum size 157x64x64cm
 Height Adjustment: 64-157cm
 Sections: 3 Pcs

SKU: 6686 BLACK BODY ■ 3800156666863
 SKU: 6687 YELLOW BODY ■ 3800156666870

**Terminal Block
Waterproof Box OT1-B5**

Rated Voltage 250V
 Material Flame Retardant PP
 Wire Range 0.5-1.5mm2
 Wire Range-T 0.5-2.5mm2
 Rated Current 16A



SKU: 6641 3800156666412
 SKU: 6642 3800156666429



**Terminal Blocks Professional
Metal-Waterproof Box**



Rated Voltage 450V
 Material Cast Aluminium
 Body Size 80x75x60mm
 Rated Current 24A



SKU: 6509 2-Connectors
 SKU: 6510 3-Connectors
 SKU: 6511 4-Connectors
 SKU: 6512 4-X-Connectors



**Lever Connectors
Easy Clip**

Rated voltage 450V
 Rated current 32A
 Wire range 18-12AWG 0.08--2.5mm2
 Ambient temperature -40°C~+105°C
 Strip length 12-13mm

SKU: 6501
 SKU: 6502
 SKU: 6503
 SKU: 6504
 SKU: 6505



Rated voltage 450V
 Rated current 32A
 Housing material: thermoplastic, 94V-0
 Flame-retardant
 Temperature: 110 degrees Celsius
 Wire range: #24 to #12 AWG solid wires

SKU: 6506
 SKU: 6507
 SKU: 6508

**Terminal Block Splitter
Waterproof Box OT1-B5**

Rated Voltage 250V
 Material Polypropylene 94 V2
 Wire Range 0.5-2.5mm2
 Rated Current 16A



SKU: 6643 3800156666436



**Terminal Block Splitter
Waterproof Box OT1-B5**

Rated Voltage 450V
 Material Polypropylene 94 V2
 Wire Range 0.5-4mm2
 Rated Current 24A



SKU: 6644 3800156666443



**Terminal Blocks Professional
Polycarbonate-Waterproof Box**

Rated Voltage 250V
 Rated Current 16A
 Material Polycarbonate
 Body Size 120x35x50 mm



SKU: 6647 2-Connectors

Rated Voltage 450V
 Rated Current 24A
 Material Polycarbonate
 Body Size 120x35x70 mm



SKU: 6648 3-Connectors



**Terminal Block Splitter
Waterproof Box OT1-B5**

Rated Voltage 450V
 Material Polypropylene 94 V2
 Wire Range 0.5-4mm2
 Rated Current 24A



SKU: 6645 3800156666450



**Terminal Block Splitter
Waterproof Box OT1-B5**

Rated Voltage 450V
 Material Polypropylene 94 V2
 Wire Range 0.5-4mm2
 Rated Current 24A



SKU: 6646 3800156666467



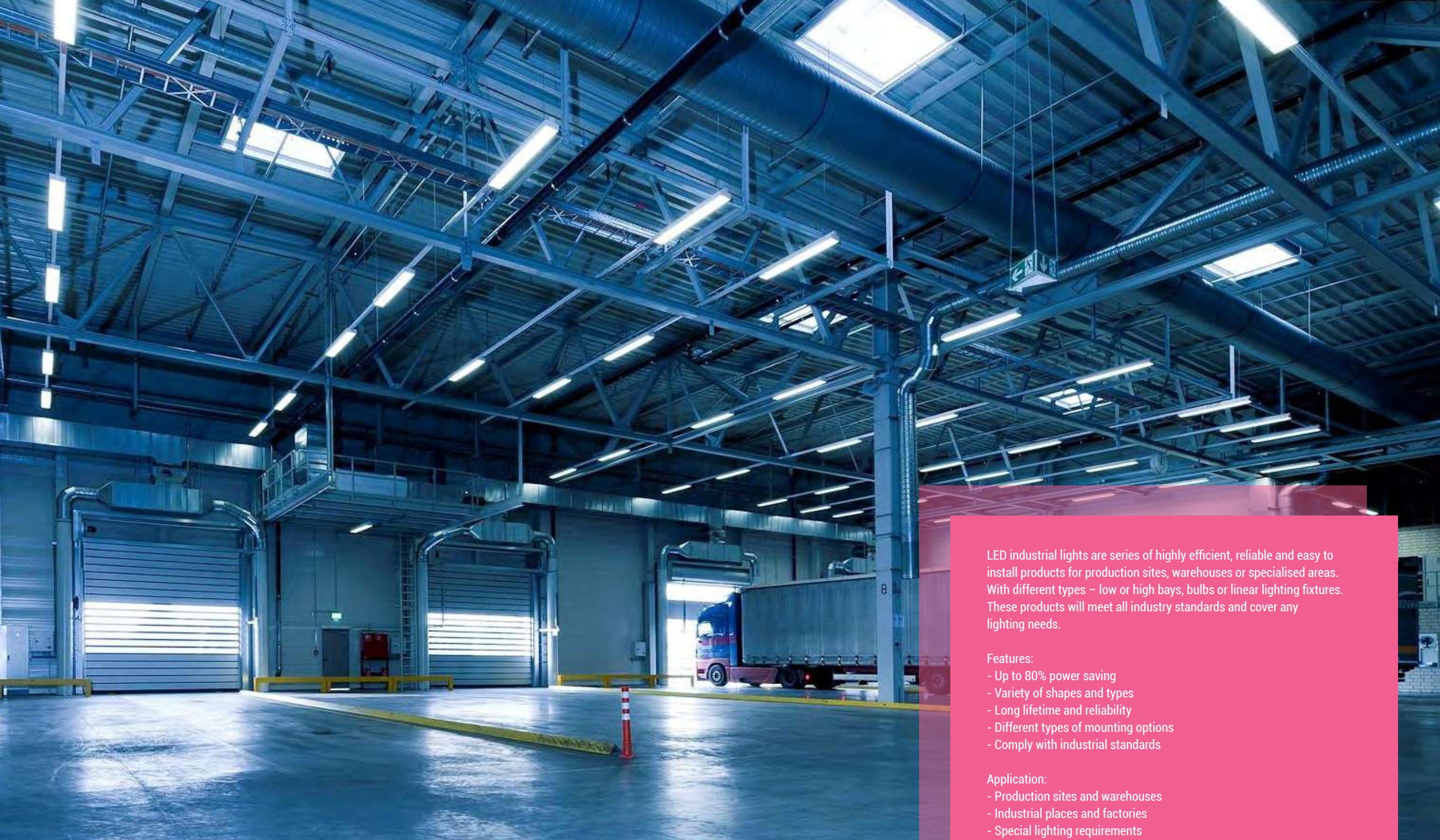

LED industrial lights are series of highly efficient, reliable and easy to install products for production sites, warehouses or specialised areas. With different types – low or high bays, bulbs or linear lighting fixtures. These products will meet all industry standards and cover any lighting needs.

Features:

- Up to 80% power saving
- Variety of shapes and types
- Long lifetime and reliability
- Different types of mounting options
- Comply with industrial standards

Application:

- Production sites and warehouses
- Industrial places and factories
- Special lighting requirements

LED STREET AND INDUSTRIAL LIGHTS



LED STREET LIGHT
8W Solar Power + Battery

Product code	SL40-A6		
Watts	8W	CRI	Ra>70
Battery	3.2V / 16.5Ah	IP Rating	IP65
Flux	950lm	Dimension	490x240x65mm
Beam Angle	120°	Body Color	Black

- * Intelligent Light Control
- * Time Switch

SKU: 9135 White Light 6000K 3800156691353



Wireless Remote Control

		>1500 Cycles icon"/>		
950 Lumens	Battery	>1500 Cycles	Solar Power	IP65



LED STREET LIGHT
35W Solar Power + Battery

Product code	SL100-A6		
Watts	35W	CRI	Ra>70
Battery	6.4V / 16.5Ah	IP Rating	IP65
Flux	2600lm	Dimension	490x240x65mm
Beam Angle	120°	Body Color	Black

- * Intelligent Light Control
- * Time Switch

SKU: 9137 White Light 6000K 3800156691377

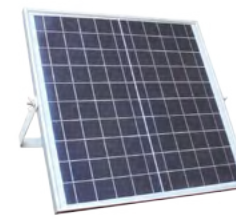

Wireless Remote Control

		>1500 Cycles icon"/>		
2600 Lumens	Battery	>1500 Cycles	Solar Power	IP65



LED STREET LIGHT
12W Solar Power + Battery

Product code	SL60-A6		
Watts	12W	CRI	Ra>70
Battery	3.2V / 22Ah	IP Rating	IP65
Flux	1200lm	Dimension	650x250x65mm
Beam Angle	120°	Body Color	Black

- * Intelligent Light Control
- * Time Switch

SKU: 9136 White Light 6000K 3800156691360



Wireless Remote Control

		>1500 Cycles icon"/>		
1200 Lumens	Battery	>1500 Cycles	Solar Power	IP65



LED STREET LIGHT
40W Solar Power + Battery

Product code	SL150-A6		
Watts	40W	CRI	Ra>70
Battery	6.4V / 22h	IP Rating	IP65
Flux	3000lm	Dimension	490x240x65mm
Beam Angle	120°	Body Color	Black

- * Intelligent Light Control
- * Time Switch

SKU: 9138 White Light 6000K 3800156691384

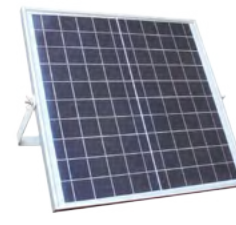

Wireless Remote Control

		>1500 Cycles icon"/>		
3000 Lumens	Battery	>1500 Cycles	Solar Power	IP65



LED STREET LIGHT
Solar Power + Battery



500 Lumens

Product code	SL8-B6	Beam Angle	120°
Watts	8W	CRI	Ra>70
Battery	3.2V 5AH	IP Rating	IP65
Flux	500lm	Body Color	Black

193mm
390x47.3mm

SKU: 9126 White Light 6000K 3800156691261

1200 Lumens

Product code	SL10-B6	Beam Angle	120°
Watts	10W	CRI	Ra>70
Battery	3.2V 10AH	IP Rating	IP65
Flux	1200lm	Body Color	Black

218mm
484x53.6mm

SKU: 9127 White Light 6000K 3800156691278

1800 Lumens

Product code	SL15-B6	Beam Angle	120°
Watts	15W	CRI	Ra>70
Battery	3.2V 15AH	IP Rating	IP65
Flux	1800lm	Body Color	Black

237mm
620x53.6mm

SKU: 9128 White Light 6000K 3800156691285

2400 Lumens

Product code	SL18-B6	Beam Angle	120°
Watts	18W	CRI	Ra>70
Battery	3.2V 20AH	IP Rating	IP65
Flux	2400lm	Body Color	Black

237mm
723x58.1mm

SKU: 9129 White Light 6000K 3800156691292



Adjusting angle

LED STREET LIGHT PF>0.9
High Lumens

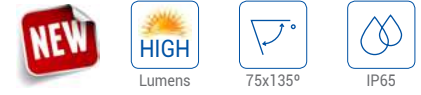

30W
3000 Lumens

Product code	SL30-A9	Beam Angle	75x135°
Watts	30W	CRI	Ra>70
Input Voltage	AC : 220-240V	IP Rating	IP65
Flux	3000lm	Body Color	Gray

438x128mm

SKU: 9201 White Light 6000K 3800156692015
SKU: 9202 Neutral White 4500K 3800156692022
SKU: 9203 Warm White 2700K 3800156692039

50W
5000 Lumens

Product code	SL50-A9	Beam Angle	75x135°
Watts	50W	CRI	Ra>70
Input Voltage	AC : 220-240V	IP Rating	IP65
Flux	5000lm	Body Color	Gray

486x151mm

SKU: 9204 White Light 6000K 3800156692046
SKU: 9205 Neutral White 4500K 3800156692053
SKU: 9206 Warm White 2700K 3800156692060

100W
10000 Lumens

Product code	SL100-A9	Beam Angle	75x135°
Watts	100W	CRI	Ra>70
Input Voltage	AC : 220-240V	IP Rating	IP65
Flux	10000lm	Body Color	Gray

564x189mm

SKU: 9207 White Light 6000K 3800156692077
SKU: 9208 Neutral White 4500K 3800156692084
SKU: 9209 Warm White 2700K 3800156692091

150W
15000 Lumens

Product code	SL150-A9	Beam Angle	75x135°
Watts	150W	CRI	Ra>70
Input Voltage	AC : 220-240V	IP Rating	IP65
Flux	15000lm	Body Color	Gray

638x210mm

SKU: 9210 White Light 6000K 3800156692107
SKU: 9211 Neutral White 4500K 3800156692114
SKU: 9212 Warm White 2700K 3800156692121

200W
20000 Lumens

Product code	SL200-A9	Beam Angle	75x135°
Watts	200W	CRI	Ra>70
Input Voltage	AC : 220-240V	IP Rating	IP65
Flux	20000lm	Body Color	Gray

695x235mm

SKU: 9213 White Light 6000K 3800156692138
SKU: 9214 Neutral White 4500K 3800156692145
SKU: 9215 Warm White 2700K 3800156692152



LED STREET LIGHT PF>0.95
High Lumens-Moso Driver

MOSO
Driver

- 5 Years Warranty
- 150 Lumens/W
- HIGH Lumens
- 120°
- IP65

100W
15000
Lumens

Product code	SL100-A7	Beam Angle	120°
Watts	100W	CRI	Ra>70
Input Voltage	AC : 220-240V	IP Rating	IP65
Flux	15000lm	Protection	Class 1

SKU: 9179 White Light 5700K 3800156691797

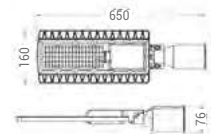

120W
18000
Lumens

Product code	SL120-A7	Beam Angle	120°
Watts	120W	CRI	Ra>70
Input Voltage	AC : 220-240V	IP Rating	IP65
Flux	18000lm	Protection	Class 1

SKU: 9180 White Light 5700K 3800156691803

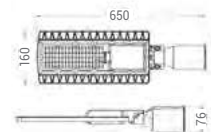

LED STREET LIGHT PF>0.95
High Lumens-Moso Driver

MOSO
Driver

- 5 Years Warranty
- 140 Lumens/W
- HIGH Lumens
- IP66

80W
11200
Lumens

Product code	SL80-A8	Beam Angle	120°
Watts	80W	CRI	Ra>70
Input Voltage	AC : 100-240V	IP Rating	IP66
Flux	11200lm	Protection	Class 1

SKU: 9196 White Light 5700K 3800156691964

100W
14000
Lumens

Product code	SL50-A8	Beam Angle	120°
Watts	100W	CRI	Ra>70
Input Voltage	AC : 100-240V	IP Rating	IP66
Flux	14000lm	Protection	Class 1

SKU: 9197 White Light 5700K 3800156691971

150W
21000
Lumens

Product code	SL150-A8	Beam Angle	120°
Watts	150W	CRI	Ra>70
Input Voltage	AC : 100-240V	IP Rating	IP66
Flux	21000lm	Protection	Class 1

SKU: 9198 White Light 5700K 3800156691988

180W
25200
Lumens

Product code	SL180-A8	Beam Angle	120°
Watts	180W	CRI	Ra>70
Input Voltage	AC : 100-240V	IP Rating	IP66
Flux	25200lm	Protection	Class 1

SKU: 9199 White Light 5700K 3800156691995



Adjusting angle



LED STREET LIGHT PF>0.9
2 pcs BOX



Product code	SL30-A2	Beam Angle	120°
Watts	30W	CRI	Ra>70
Input Voltage	AC : 100-240V	IP Rating	IP65
Flux	4050lm	Protection	Class 1

SKU: 9156 White Light ■ 5700K 3800156691568

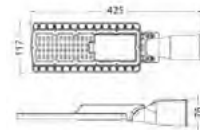

Product code	SL50-A2	Beam Angle	120°
Watts	50W	CRI	Ra>70
Input Voltage	AC : 100-240V	IP Rating	IP65
Flux	7500lm	Protection	Class 1

SKU: 9157 White Light ■ 5700K 3800156691575

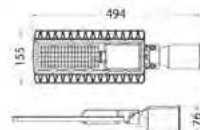

Product code	SL60-A2	Beam Angle	120°
Watts	60W	CRI	Ra>70
Input Voltage	AC : 100-240V	IP Rating	IP65
Flux	8100lm	Protection	Class 1

SKU: 9158 White Light ■ 5700K 3800156691582

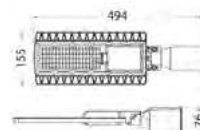

LED STREET LIGHT PF>0.9
2 pcs BOX



Product code	SL20-A1	Beam Angle	120°
Watts	20W	CRI	Ra>70
Input Voltage	AC : 220-240V	IP Rating	IP65
Flux	2000lm	Protection	Class 2

SKU: 9171 White Light ■ 6000K 3800156691711

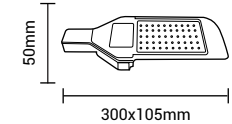

Product code	SL50-A1	Beam Angle	120°
Watts	50W	CRI	Ra>70
Input Voltage	AC : 220-240V	IP Rating	IP65
Flux	5000lm	Protection	Class 2

SKU: 9172 White Light ■ 6000K 3800156691728

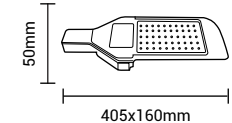

Product code	SL80-A1	Beam Angle	120°
Watts	80W	CRI	Ra>70
Input Voltage	AC : 220-240V	IP Rating	IP65
Flux	8000lm	Protection	Class 2

SKU: 9173 White Light ■ 6000K 3800156691735

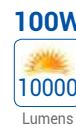
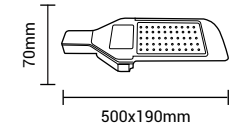

Product code	SL100-A1	Beam Angle	120°
Watts	100W	CRI	Ra>70
Input Voltage	AC : 220-240V	IP Rating	IP65
Flux	10000lm	Protection	Class 2

SKU: 9174 White Light ■ 6000K 3800156691742

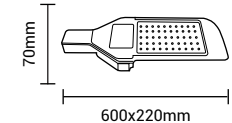



LED STREET LIGHT PF>0.9
Bridgelux 3030 Chips

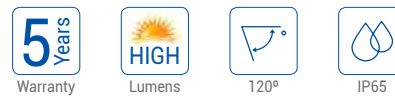

150W
14250
Lumens

Product code	SL150-A3	Beam Angle	120°
Watts	150W	CRI	Ra>70
Input Voltage	AC : 220-240V	IP Rating	IP65
Flux	14250lm	Protection	Class 1

SKU: 9181 White Light 5700K 3800156691810

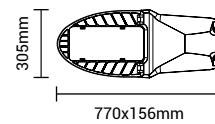

200W
19000
Lumens

Product code	SL200-A3	Beam Angle	120°
Watts	200W	CRI	Ra>70
Input Voltage	AC : 220-240V	IP Rating	IP65
Flux	19000lm	Protection	Class 1

SKU: 9182 White Light 5700K 3800156691827

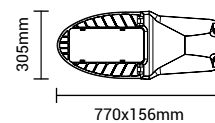

Adapter Matt Grey Φ60mm to Φ40mm



SKU: 9118 3800156691186

Adapter Φ60mm to Φ60 mm Adjustable Angle 90°



SKU: 9119 3800156691193

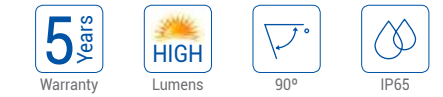

LED INDUSTRIAL LIGHTS PF>0.9
Stadium Floodlight

100W
10000
Lumens

Product code	SL100-A5	Beam Angle	90°
Watts	100W	CRI	Ra>70
Input Voltage	AC : 220-240V	IP Rating	IP65
Flux	10000lm	Protection	Class 1

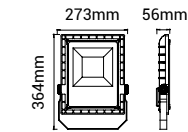

SKU: 9175 White Light 5700K 3800156691759

150W
16500
Lumens

Product code	SL150-A5	Beam Angle	90°
Watts	150W	CRI	Ra>70
Input Voltage	AC : 220-240V	IP Rating	IP65
Flux	16500lm	Protection	Class 1

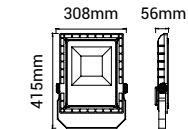

SKU: 9176 White Light 5700K 3800156691766

240W
26400
Lumens

Product code	SL240-A5	Beam Angle	90°
Watts	240W	CRI	Ra>70
Input Voltage	AC : 220-240V	IP Rating	IP65
Flux	26400lm	Protection	Class 1

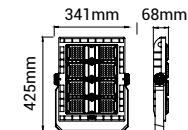

SKU: 9177 White Light 5700K 3800156691773

480W
68000
Lumens

Product code	SL480-A5	Beam Angle	90°
Watts	480W	CRI	Ra>70
Input Voltage	AC : 220-240V	IP Rating	IP65
Flux	68000lm	Protection	Class 1

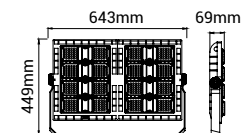

SKU: 9178 White Light 5700K 3800156691780





**LED INDUSTRIAL LIGHT HIGH LUMEN
HIGH BAY PF>0.9**



100W 18000 Lumens	Product code	HB110-A1	Beam Angle	90°
	Watts	100W	CRI	Ra>80
	Input Voltage	AC : 220-240V	IP Rating	IP65
	Flux	18000lm	Protection	Class 1

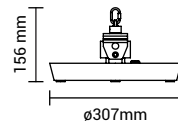

SKU: 8190 White Light ■ 5700K 3800156681903

150W 27000 Lumens	Product code	HB150-A3	Beam Angle	90°
	Watts	150W	CRI	Ra>80
	Input Voltage	AC : 220-240V	IP Rating	IP65
	Flux	27000lm	Protection	Class 1

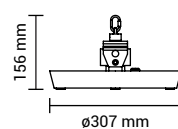

SKU: 8191 White Light ■ 5700K 3800156681910

200W 36000 Lumens	Product code	HB210-A1	Beam Angle	90°
	Watts	200W	CRI	Ra>80
	Input Voltage	AC : 220-240V	IP Rating	IP65
	Flux	36000lm	Protection	Class 1

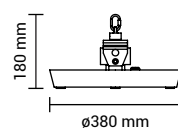

SKU: 8192 White Light ■ 5700K 3800156681927



**LED INDUSTRIAL LIGHT
HIGH BAY UFO PF>0.9**



100W 11000 Lumens	Product code	HB100-A5	Beam Angle	90°
	Watts	100W	CRI	Ra>80
	Input Voltage	AC : 220-240V	IP Rating	IP54
	Flux	11000lm	Protection	Class 1

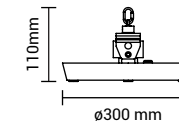

SKU: 8140 White Light ■ 5700K 3800156681408

150W 16500 Lumens	Product code	HB150-A5	Beam Angle	90°
	Watts	150W	CRI	Ra>80
	Input Voltage	AC : 220-240V	IP Rating	IP54
	Flux	16500lm	Protection	Class 1

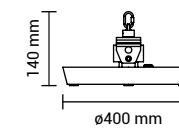

SKU: 8141 White Light ■ 5700K 3800156681415

200W 22000 Lumens	Product code	HB200-A5	Beam Angle	90°
	Watts	200W	CRI	Ra>80
	Input Voltage	AC : 220-240V	IP Rating	IP54
	Flux	22000lm	Protection	Class 1

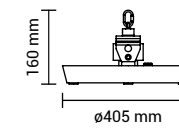

SKU: 8126 White Light ■ 5700K 3800156681262

NEW

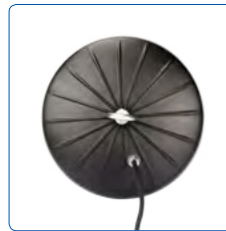

LED INDUSTRIAL LIGHT
HIGH BAY - UFO - 90°

50W
5000 Lumens

Product code	HB50-A8	Beam Angle	90°
Watts	50W	CRI	Ra>70
Input Voltage	AC : 220-240V	IP Rating	IP65
Flux	5000lm	Protection	Class 1

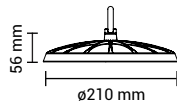

SKU: 8201 White Light 6000K 3800156682016
SKU: 8202 Neutral White 4500K 3800156682023

100W
10000 Lumens

Product code	HB100-A8	Beam Angle	90°
Watts	100W	CRI	Ra>70
Input Voltage	AC : 220-240V	IP Rating	IP65
Flux	10000lm	Protection	Class 1

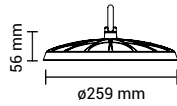

SKU: 8203 White Light 6000K 3800156682030
SKU: 8204 Neutral White 4500K 3800156682047

150W
15000 Lumens

Product code	HB150-A8	Beam Angle	90°
Watts	150W	CRI	Ra>70
Input Voltage	AC : 220-240V	IP Rating	IP65
Flux	15000lm	Protection	Class 1

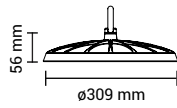

SKU: 8205 White Light 6000K 3800156682054
SKU: 8206 Neutral White 4500K 3800156682061

200W
20000 Lumens

Product code	HB200-A8	Beam Angle	90°
Watts	200W	CRI	Ra>70
Input Voltage	AC : 220-240V	IP Rating	IP65
Flux	20000lm	Protection	Class 1

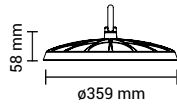

SKU: 8207 White Light 6000K 3800156682078
SKU: 8208 Neutral White 4500K 3800156682085

NEW

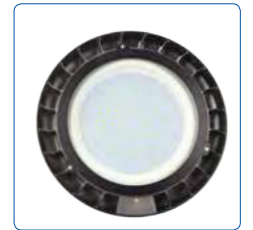

LED INDUSTRIAL LIGHT
HIGH BAY - UFO - 120°

50W
5000 Lumens

Product code	HB50-A8	Beam Angle	120°
Watts	50W	CRI	Ra>70
Input Voltage	AC : 220-240V	IP Rating	IP65
Flux	5000lm	Protection	Class 1

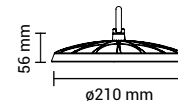

SKU: 8211 White Light 6000K 3800156682115
SKU: 8212 Neutral White 4500K 3800156682122

100W
10000 Lumens

Product code	HB100-A8	Beam Angle	120°
Watts	100W	CRI	Ra>70
Input Voltage	AC : 220-240V	IP Rating	IP65
Flux	10000lm	Protection	Class 1

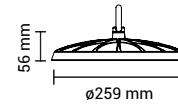

SKU: 8213 White Light 6000K 3800156682139
SKU: 8214 Neutral White 4500K 3800156682146

150W
15000 Lumens

Product code	HB150-A8	Beam Angle	120°
Watts	150W	CRI	Ra>70
Input Voltage	AC : 220-240V	IP Rating	IP65
Flux	15000lm	Protection	Class 1

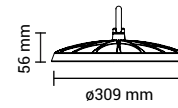

SKU: 8215 White Light 6000K 3800156682153
SKU: 8216 Neutral White 4500K 3800156682160

200W
20000 Lumens

Product code	HB200-A8	Beam Angle	120°
Watts	200W	CRI	Ra>70
Input Voltage	AC : 220-240V	IP Rating	IP65
Flux	20000lm	Protection	Class 1

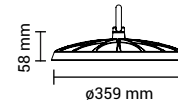

SKU: 8217 White Light 6000K 3800156682177
SKU: 8218 Neutral White 4500K 3800156682184



LED INDUSTRIAL LIGHT
HIGH BAY - UFO 2 - 90°

50W  Lumens	Product code	HB50-A6	Beam Angle	90°
	Watts	50W	CRI	Ra>70
	Input Voltage	AC : 220-240V	IP Rating	IP65
	Flux	4250lm	Protection	Class 1

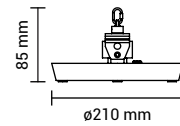



SKU: 8166 White Light  6000K 3800156681668
SKU: 8167 Neutral White  4500K 3800156681675

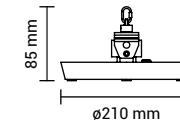

LED INDUSTRIAL LIGHT
HIGH BAY - UFO 2 - 120°

50W  Lumens	Product code	HB50-A6	Beam Angle	120°
	Watts	50W	CRI	Ra>70
	Input Voltage	AC : 220-240V	IP Rating	IP65
	Flux	4250lm	Protection	Class 1



SKU: 8174 White Light  6000K 3800156681743
SKU: 8175 Neutral White  4500K 3800156681750

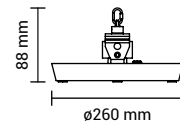

100W  Lumens	Product code	HB100-A6	Beam Angle	90°
	Watts	100W	CRI	Ra>70
	Input Voltage	AC : 220-240V	IP Rating	IP65
	Flux	8500lm	Protection	Class 1

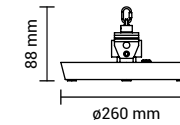

SKU: 8168 White Light  6000K 3800156681682
SKU: 8169 Neutral White  4500K 3800156681699

100W  Lumens	Product code	HB100-A6	Beam Angle	120°
	Watts	100W	CRI	Ra>70
	Input Voltage	AC : 220-240V	IP Rating	IP65
	Flux	8500lm	Protection	Class 1



SKU: 8176 White Light  6000K 3800156681767
SKU: 8177 Neutral White  4500K 3800156681774

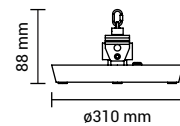

150W  Lumens	Product code	HB150-A6	Beam Angle	90°
	Watts	150W	CRI	Ra>70
	Input Voltage	AC : 220-240V	IP Rating	IP65
	Flux	12750lm	Protection	Class 1

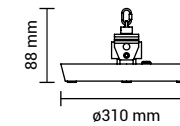

SKU: 8170 White Light  6000K 3800156681705
SKU: 8171 Neutral White  4500K 3800156681712

150W  Lumens	Product code	HB150-A6	Beam Angle	120°
	Watts	150W	CRI	Ra>70
	Input Voltage	AC : 220-240V	IP Rating	IP65
	Flux	12750lm	Protection	Class 1



SKU: 8178 White Light  6000K 3800156681781
SKU: 8179 Neutral White  4500K 3800156681798

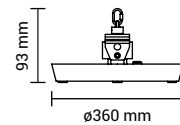

200W  Lumens	Product code	HB200-A6	Beam Angle	90°
	Watts	200W	CRI	Ra>70
	Input Voltage	AC : 220-240V	IP Rating	IP65
	Flux	17000lm	Protection	Class 1

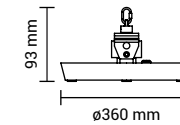

SKU: 8172 White Light  6000K 3800156681729
SKU: 8173 Neutral White  4500K 3800156681736

200W  Lumens	Product code	HB200-A6	Beam Angle	120°
	Watts	200W	CRI	Ra>70
	Input Voltage	AC : 220-240V	IP Rating	IP65
	Flux	17000lm	Protection	Class 1



SKU: 8180 White Light  6000K 3800156681804
SKU: 8181 Neutral White  4500K 3800156681811



LED INDUSTRIAL LIGHT PF>0.9
50W Linear High Bay



Product code	HB50-A7	CRI	Ra>70
Watts	50W	IP Rating	IP65
Input Voltage	AC: 220-240V	Dimension	298x254x58mm
Flux	4250lm	Protection	Class 1
Beam Angle	120°*60°		

SKU: 8182 White Light 6000K 3800156681828



LED INDUSTRIAL LIGHT PF>0.9
200W Linear High Bay



Product code	HB200-A7	CRI	Ra>70
Watts	200W	IP Rating	IP65
Input Voltage	AC: 220-240V	Dimension	565x290x65mm
Flux	17000lm	Protection	Class 1
Beam Angle	120°*60°		

SKU: 8185 White Light 6000K 3800156681859



LED INDUSTRIAL LIGHT PF>0.9
100W Linear High Bay



Product code	HB100-A7	CRI	Ra>70
Watts	100W	IP Rating	IP65
Input Voltage	AC: 220-240V	Dimension	305x290x65mm
Flux	8500lm	Protection	Class 1
Beam Angle	120°*60°		

SKU: 8183 White Light 6000K 3800156681835



LED INDUSTRIAL LIGHT PF>0.9
300W Linear High Bay



Product code	HB300-A7	CRI	Ra>70
Watts	300W	IP Rating	IP65
Input Voltage	AC: 220-240V	Dimension	565x515x65mm
Flux	25500lm	Protection	Class 1
Beam Angle	120°*60°		

SKU: 8186 White Light 6000K 3800156681866



LED INDUSTRIAL LIGHT PF>0.9
150W Linear High Bay



Product code	HB150-A7	CRI	Ra>70
Watts	150W	IP Rating	IP65
Input Voltage	AC: 220-240V	Dimension	305x415x65mm
Flux	12750lm	Protection	Class 1
Beam Angle	120°*60°		

SKU: 8184 White Light 6000K 3800156681842



LED INDUSTRIAL LIGHT PF>0.9
400W Linear High Bay



Product code	HB400-A7	CRI	Ra>70
Watts	400W	IP Rating	IP65
Input Voltage	AC: 220-240V	Dimension	565x545x65mm
Flux	34000lm	Protection	Class 1
Beam Angle	120°*60°		

SKU: 8187 White Light 6000K 3800156681873



LED INDUSTRIAL LIGHT
Linear High Bay



Product code HB50-A2
Watts 50W
Input Voltage AC : 220-240V
Flux 5000lm
Beam Angle 120*60°
CRI Ra>70
IP Rating IP44
Body Color Class 1

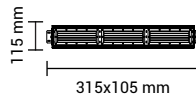

SKU: 8151 White Light 6000K 3800156681514
SKU: 8152 Neutral White 4500K 3800156681521



Product code HB100-A2
Watts 50W
Input Voltage AC : 220-240V
Flux 10000lm
Beam Angle 120*60°
CRI Ra>70
IP Rating IP44
Body Color Black

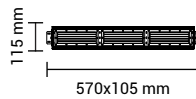

SKU: 8153 White Light 6000K 3800156681538
SKU: 8154 Neutral White 4500K 3800156681545



Product code HB150-A2
Watts 50W
Input Voltage AC : 220-240V
Flux 15000lm
Beam Angle 120*60°
CRI Ra>70
IP Rating IP44
Body Color Black

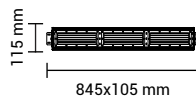

SKU: 8155 White Light 6000K 3800156681552
SKU: 8156 Neutral White 4500K 3800156681569



Product code HB200-A2
Watts 50W
Input Voltage AC : 220-240V
Flux 20000lm
Beam Angle 120*60°
CRI Ra>70
IP Rating IP44
Body Color Black

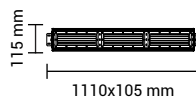

SKU: 8157 White Light 6000K 3800156681576
SKU: 8158 Neutral White 4500K 3800156681583



LED INDUSTRIAL Bulb PF>0.9
40W E27



Product code HB40-A1
Watts 40W
Input Voltage AC : 180-264V
Flux 4100lm
Beam Angle 270°
Socket E27
CRI Ra>80
IP Rating IP20
Dimension ø90x212 mm
Dimmable NO

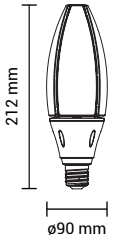

SKU: 225 White Light 6000K 3800156602250
SKU: 226 Neutral White 4000K 3800156602267

LED INDUSTRIAL Bulb PF>0.9
50W E40



Product code HB50-A3
Watts 50W
Input Voltage AC : 110-264V
Flux 5000lm
Beam Angle 270°
Socket E40
CRI Ra>70
IP Rating IP20
Dimension ø75x235 mm
Dimmable NO

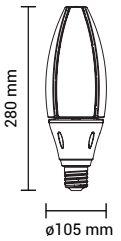

SKU: 221 White Light 5700K 3800156602212



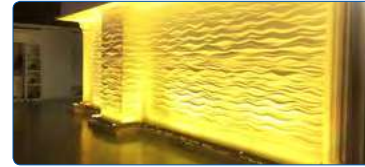

LED Wall Washers
30°



Product code	WW9-A1	Beam Angle	30°
Watts	9W	CRI	Ra>70
Input Voltage	AC : 220-240V	IP Rating	IP65
Flux	700lm	Body Color	Black

SKU: 7134 White Light 6000K 3800156671348
SKU: 7131 Warm White 2700K 3800156671317

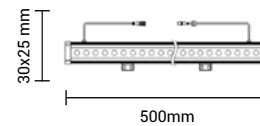

Product code	WW18-A1	Beam Angle	30°
Watts	18W	CRI	Ra>70
Input Voltage	AC : 220-240V	IP Rating	IP65
Flux	1400lm	Protection	Black

SKU: 7135 White Light 6000K 3800156671355
SKU: 7132 Warm White 2700K 3800156671324

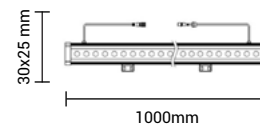

Product code	WW36-A1	Beam Angle	30°
Watts	36W	CRI	Ra>70
Input Voltage	AC : 220-240V	IP Rating	IP65
Flux	2800lm	Protection	Black

SKU: 7136 White Light 6000K 3800156671362
SKU: 7133 Warm White 2700K 3800156671331

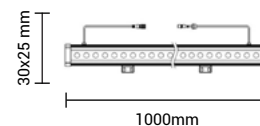

LED Wall Washer
36W



Product code	WW36-A1	CRI	Ra>70
Watts	36W	IP Rating	IP67
Input Voltage	AC : 220-240V	Dimension	333x200x120
Flux	2880lm	Body Color	Gray
Beam Angle	15°	Dimmable	NO
Shape	Square Head		



SKU: 7121 Warm White 3000K 3800156671218

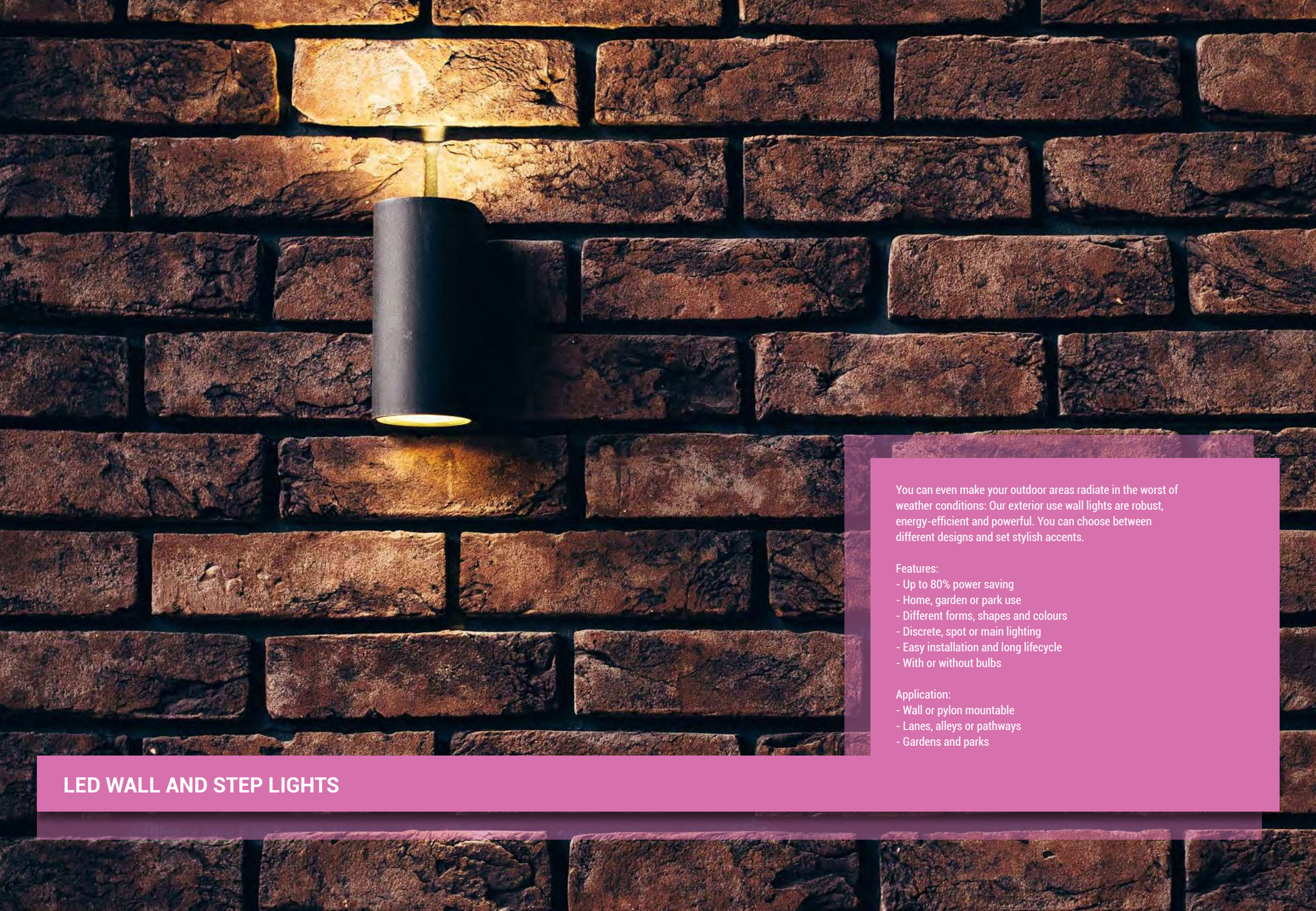

LED WALL AND STEP LIGHTS

You can even make your outdoor areas radiate in the worst of weather conditions: Our exterior use wall lights are robust, energy-efficient and powerful. You can choose between different designs and set stylish accents.

Features:

- Up to 80% power saving
- Home, garden or park use
- Different forms, shapes and colours
- Discrete, spot or main lighting
- Easy installation and long lifecycle
- With or without bulbs

Application:

- Wall or pylon mountable
- Lanes, alleys or pathways
- Gardens and parks

NEW



LED Wall Light 12W

Product code	OT1-A2	CRI	Ra>80
Watts	12W	IP Rating	IP20
Input Voltage	AC : 200-240V	Dimension	315x90x30mm
Flux	600lm	Body Color	WHITE
Beam Angle	160°	Dimmable	NO
Material	Aluminium		



SKU: 2095 Warm White 3000K 3800156620957

NEW



LED Wall Light 12W

Product code	OT1-A2	CRI	Ra>80
Watts	12W	IP Rating	IP20
Input Voltage	AC : 200-240V	Dimension	315x90x30mm
Flux	600lm	Body Color	BLACK
Beam Angle	160°	Dimmable	NO
Material	Aluminium		



SKU: 2096 Warm White 3000K 3800156620964

NEW



LED Solar Wall Light 1W

Product code	OT1-A2	Solar Power	Yes
Watts	1W	Lumens	60
Voltage	5.5V	Beam Angle	80°
Flux	60lm	IP Rating	IP44
Beam Angle	80°	Body Color	White
Battery	3.7V/18Ah	Dimmable	NO



SKU: 2085 White Light 6000K 3800156620858
SKU: 2086 Neutral White 4500K 3800156620865

NEW



LED Solar Wall Light 1W

Product code	OT1-A2	Solar Power	Yes
Watts	1W	Lumens	60
Voltage	5.5V	Beam Angle	80°
Flux	60lm	IP Rating	IP44
Beam Angle	80°	Body Color	Black
Battery	3.7V/18Ah	Dimmable	NO



SKU: 2087 White Light 6000K 3800156620872
SKU: 2088 Neutral White 4500K 3800156620889

NEW



LED Wall Light 12W

Product code	OT1-A2	CRI	Ra>80
Watts	12W	IP Rating	IP65
Input Voltage	AC : 200-240V	Dimension	ø160x60mm
Flux	1200lm	Body Color	White
Beam Angle	90°	Dimmable	NO
Material	Plastic		

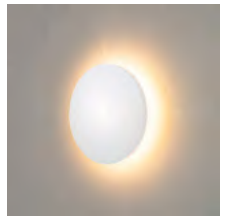

SKU: 2089 Warm White 3000K 3800156620896

NEW



LED Wall Light 12W

Product code	OT1-A2	CRI	Ra>80
Watts	12W	IP Rating	IP65
Input Voltage	AC : 200-240V	Dimension	ø160x60mm
Flux	1200lm	Body Color	BLACK
Beam Angle	90°	Dimmable	NO
Material	Plastic		



SKU: 2090 Warm White 3000K 3800156620902

NEW



LED Wall Light - Aluminium 12W

Product code	OT1-A2	CRI	Ra>80
Watts	12W	IP Rating	IP65
Input Voltage	AC : 200-240V	Dimension	ø150x46mm
Flux	670lm	Body Color	WHITE
Beam Angle	90°	Dimmable	NO
Material	Aluminium		



SKU: 2091 Warm White 3000K 3800156620919

NEW



LED Wall Light - Aluminium 12W

Product code	OT1-A2	CRI	Ra>80
Watts	12W	IP Rating	IP65
Input Voltage	AC : 200-240V	Dimension	ø150x46mm
Flux	670lm	Body Color	BLACK
Beam Angle	90°	Dimmable	NO
Material	Aluminium		



SKU: 2092 Warm White 3000K 3800156620926



**LED Wall / Ceiling Light
15W**

Product code	WL15-A1	CRI	Ra>80
Watts	15W	IP Rating	IP65
Input Voltage	AC : 220-240V	Dimension	ø169x100 mm
Flux	80lm	Body Color	BLACK
Beam Angle	120°	Dimmable	NO
Shape	Round		

SKU: 7529 Neutral White 4200K 3800156675292
SKU: 7528 Warm White 3000K 3800156675285

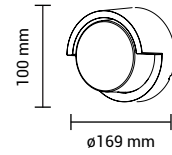

**LED Solar Wall Light
16W**

Product code	OT1-A2
Watts	16W
Input Voltage	220-240V
Flux	1120lm
Beam Angle	90°
Material	Aluminium
CRI	Ra>80
IP Rating	IP20
Dimension	800x60x100mm
Dimmable	NO

SKU: 2093 Neutral White 4500K 3800156620933
SKU: 2094 Warm White 3000K 3800156620940

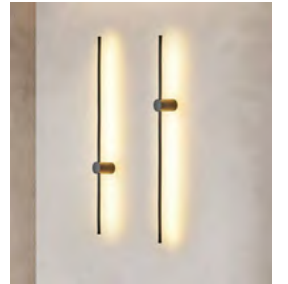

**LED Wall / Ceiling Light
15W**

Product code	WL15-A1	CRI	Ra>80
Watts	15W	IP Rating	IP65
Input Voltage	AC : 220-240V	Dimension	160x160x100 mm
Flux	80lm	Body Color	BLACK
Beam Angle	120°	Dimmable	NO
Shape	Square		

SKU: 7531 Neutral White 4200K 3800156675315
SKU: 7530 Warm White 3000K 3800156675308

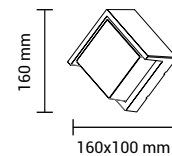

**LED Wall Light
9W**

Product code	WL9-A1	CRI	Ra>80
Watts	12W	IP Rating	IP54
Input Voltage	AC : 200-240V	Dimension	230x110x76
Flux	780lm	Body Color	BLACK
Beam Angle	6°	Dimmable	NO
Shape	Single Head		

SKU: 7404 Neutral White 4000K 3800156674042
SKU: 7403 Warm White 3000K 3800156674035

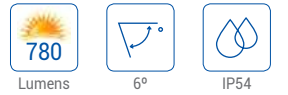

**LED Wall / Ceiling Light
15W**

Product code	WL15-A1	CRI	Ra>80
Watts	15W	IP Rating	IP65
Input Voltage	AC : 220-240V	Dimension	ø169x100 mm
Flux	1000lm	Body Color	BLACK
Beam Angle	145°	Dimmable	NO
Shape	Round		

SKU: 7533 Neutral White 4200K 3800156675339
SKU: 7532 Warm White 3000K 3800156675322

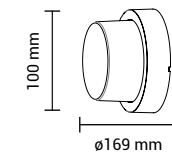

**LED BULKHEAD WALL LIGHT
12W**

Product code	WL12-A3	CRI	Ra>80
Watts	12W	IP Rating	IP65
Input Voltage	AC : 220-240V	Dimension	230x110x76mm
Flux	780lm	Body Color	GREY
Beam Angle	120°	Dimmable	NO
Shape	Rectangle		

SKU: 7527 Neutral White 4200K 3800156675278
SKU: 7526 Warm White 3000K 3800156675261

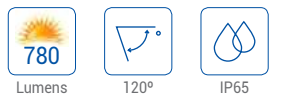

**LED Wall / Ceiling Light
15W**

Product code	WL15-A1	CRI	Ra>80
Watts	15W	IP Rating	IP65
Input Voltage	AC : 220-240V	Dimension	160x160x100 mm
Flux	1000lm	Body Color	BLACK
Beam Angle	145°	Dimmable	NO
Shape	Square		

SKU: 7535 Neutral White 4200K 3800156675353
SKU: 7534 Warm White 3000K 3800156675346

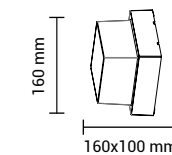



**LED Wall Light
6W**

Product code	WL6-A4	CRI	Ra>80
Watts	6W	IP Rating	IP54
Input Voltage	AC : 220-240V	Dimension	110x54x97
Flux	660lm	Body Color	WHITE
Beam Angle	120°	Dimmable	NO
Shape	Single Head		

SKU: 7478 Neutral White 4000K 3800156674783
 SKU: 7475 Warm White 3000K 3800156674752



**LED Wall Light
2x6W**

Product code	WL12-A2	CRI	Ra>80
Watts	12W	IP Rating	IP54
Input Voltage	AC : 220-240V	Dimension	221x54x97mm
Flux	1320lm	Body Color	WHITE
Beam Angle	120°	Dimmable	NO
Shape	Double Head		

SKU: 7484 Neutral White 4000K 3800156674844
 SKU: 7481 Warm White 3000K 3800156674813



**LED Wall Light
6W**

Product code	WL6-A4	CRI	Ra>80
Watts	6W	IP Rating	IP54
Input Voltage	AC : 220-240V	Dimension	110x54x97
Flux	660lm	Body Color	BLACK
Beam Angle	120°	Dimmable	NO
Shape	Single Head		

SKU: 7479 Neutral White 4000K 3800156674790
 SKU: 7476 Warm White 3000K 3800156674769



**LED Wall Light
2x6W**

Product code	WL12-A2	CRI	Ra>80
Watts	12W	IP Rating	IP54
Input Voltage	AC : 220-240V	Dimension	221x54x97mm
Flux	1320lm	Body Color	BLACK
Beam Angle	120°	Dimmable	NO
Shape	Double Head		

SKU: 7485 Neutral White 4000K 3800156674851
 SKU: 7482 Warm White 3000K 3800156674820



**LED Wall Light
6W**

Product code	WL6-A4	CRI	Ra>80
Watts	6W	IP Rating	IP54
Input Voltage	AC : 220-240V	Dimension	110x54x97
Flux	660lm	Body Color	GREY
Beam Angle	120°	Dimmable	NO
Shape	Single Head		

SKU: 7480 Neutral White 4000K 3800156674806
 SKU: 7477 Warm White 3000K 3800156674776



**LED Wall Light
2x6W**

Product code	WL12-A2	CRI	Ra>80
Watts	12W	IP Rating	IP54
Input Voltage	AC : 220-240V	Dimension	221x54x97mm
Flux	1320lm	Body Color	GREY
Beam Angle	120°	Dimmable	NO
Shape	Double Head		

SKU: 7486 Neutral White 4000K 3800156674868
 SKU: 7483 Warm White 3000K 3800156674837





**LED Wall Light
6W**

Product code WL6-A3
 Watts 6W CRI Ra>80
 Input Voltage AC : 220-240V IP Rating IP54
 Flux 660lm Dimension 90x90x200mm
 Beam Angle Up 15°-Down 90° Body Color WHITE
 Shape Triangle Dimmable NO

SKU: 7472 Neutral White 4200K 3800156674721
 SKU: 7469 Warm White 3000K 3800156674691

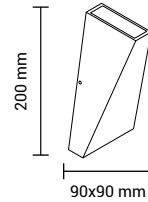

**LED Wall Light
6W**

Product code WL6-A2
 Watts 6W CRI Ra>80
 Input Voltage AC : 220-240V IP Rating IP54
 Flux 660lm Dimension 140x115x100mm
 Beam Angle 0°- 90° Body Color WHITE
 Shape Round Dimmable NO

SKU: 7466 Neutral White 4000K 3800156674660
 SKU: 7463 Warm White 3000K 3800156674639

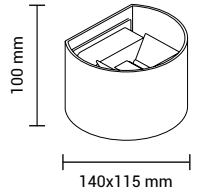

**LED Wall Light
6W**

Product code WL6-A3
 Watts 6W CRI Ra>80
 Input Voltage AC : 220-240V IP Rating IP54
 Flux 660lm Dimension 90x90x200mm
 Beam Angle Up 15°-Down 90° Body Color BLACK
 Shape Triangle Dimmable NO

SKU: 7473 Neutral White 4200K 3800156674738
 SKU: 7470 Warm White 3000K 3800156674707

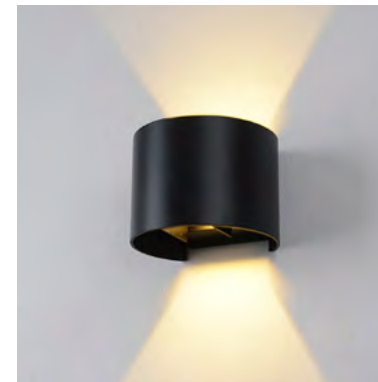
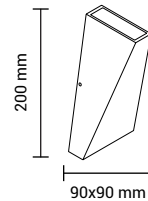

**LED Wall Light
6W**

Product code WL6-A2
 Watts 6W CRI Ra>80
 Input Voltage AC : 220-240V IP Rating IP54
 Flux 660lm Dimension 140x115x100mm
 Beam Angle 0°- 90° Body Color BLACK
 Shape Round Dimmable NO

SKU: 7467 Neutral White 4000K 3800156674677
 SKU: 7464 Warm White 3000K 3800156674646

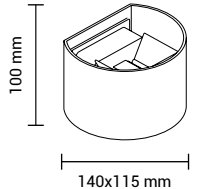

**LED Wall Light
6W**

Product code WL6-A3
 Watts 6W CRI Ra>80
 Input Voltage AC : 220-240V IP Rating IP54
 Flux 660lm Dimension 90x90x200mm
 Beam Angle Up 15°-Down 90° Body Color GREY
 Shape Triangle Dimmable NO

SKU: 7474 Neutral White 4200K 3800156674745
 SKU: 7471 Warm White 3000K 3800156674714

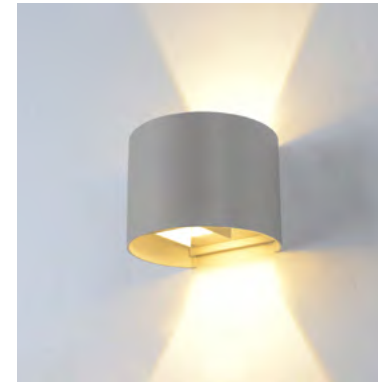
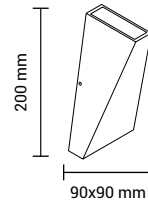

**LED Wall Light
6W**

Product code WL6-A2
 Watts 6W CRI Ra>80
 Input Voltage AC : 220-240V IP Rating IP54
 Flux 660lm Dimension 140x115x100mm
 Beam Angle 0°- 90° Body Color GREY
 Shape Round Dimmable NO

SKU: 7468 Neutral White 4000K 3800156674684
 SKU: 7465 Warm White 3000K 3800156674653

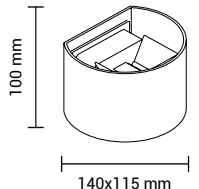



LED Wall Light 6W

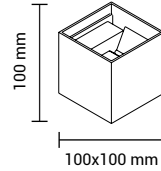

Product code	WL6-A1	CRI	Ra>80
Watts	6W	IP Rating	IP54
Input Voltage	AC : 220-240V	Dimension	100x100 mm
Flux	660lm	Body Colors	White ; Black ; Grey
Beam Angle	0°-90°	Dimmable	NO
Shape	Square		

WHITE			
SKU: 7454	Neutral White	4000K	3800156674547
SKU: 7451	Warm White	3000K	3800156674516
BLACK			
SKU: 7455	Neutral White	4000K	3800156674554
SKU: 7452	Warm White	3000K	3800156674523
GREY			
SKU: 7456	Neutral White	4000K	3800156674561
SKU: 7453	Warm White	3000K	3800156674530

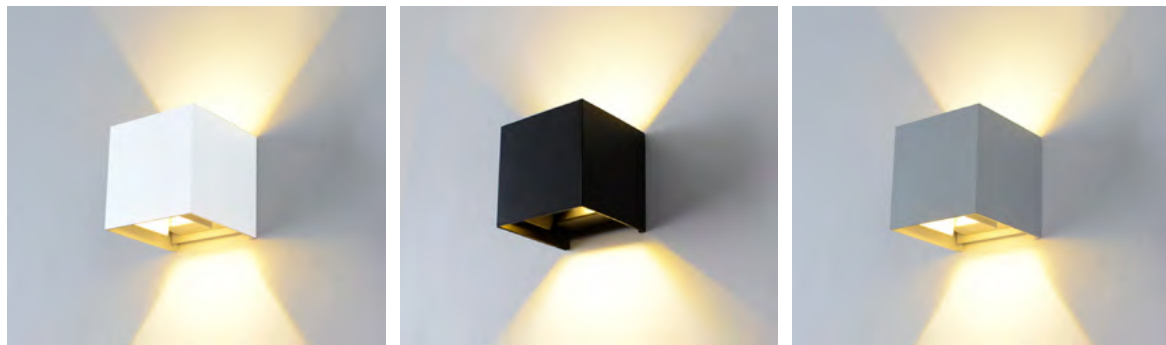

LED Wall Light 12W

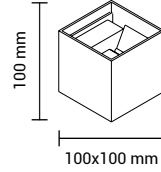

Product code	WL12-A1	CRI	Ra>80
Watts	12W	IP Rating	IP54
Input Voltage	AC : 220-240V	Dimension	100x100 mm
Flux	1320lm	Body Colors	White ; Black ; Grey
Beam Angle	0°-90°	Dimmable	NO
Shape	Square		

WHITE			
SKU: 7460	Neutral White	4000K	3800156674608
SKU: 7457	Warm White	3000K	3800156674578
BLACK			
SKU: 7461	Neutral White	4000K	3800156674615
SKU: 7458	Warm White	3000K	3800156674585
GREY			
SKU: 7462	Neutral White	4000K	3800156674622
SKU: 7459	Warm White	3000K	3800156674592

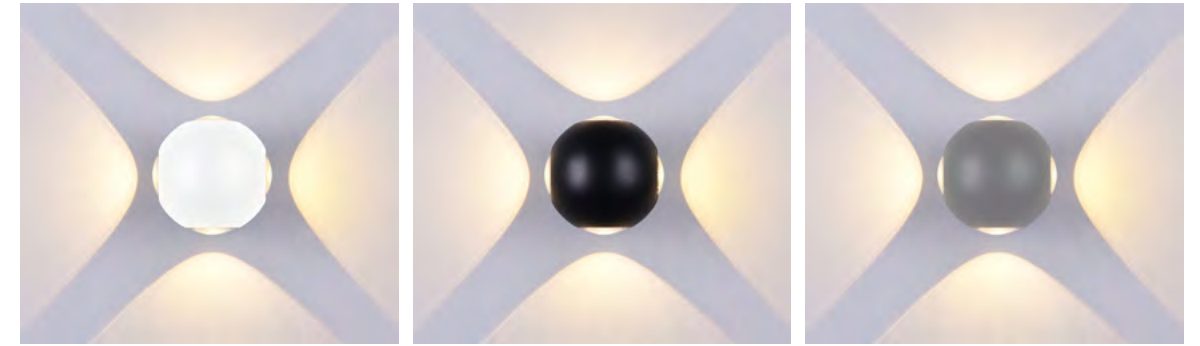

LED Wall Light 4W-4 Beam

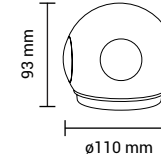

Product code	WL4-A1	CRI	Ra>80
Watts	4W	IP Rating	IP54
Input Voltage	AC : 220-240V	Dimension	ø110x93 mm
Flux	440lm	Body Colors	White ; Black ; Grey
Beam Angle	90°	Dimmable	NO
Shape	Round		

WHITE			
SKU: 7490	Neutral White	4000K	3800156674905
SKU: 7487	Warm White	3000K	3800156674875
BLACK			
SKU: 7491	Neutral White	4000K	3800156674912
SKU: 7488	Warm White	3000K	3800156674882
GREY			
SKU: 7492	Neutral White	4000K	3800156674929
SKU: 7489	Warm White	3000K	3800156674899



LED Wall Light 6W-2 Beam

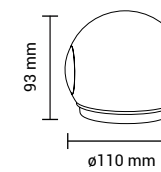

Product code	WL6-A5	CRI	Ra>80
Watts	6W	IP Rating	IP54
Input Voltage	AC : 220-240V	Dimension	ø110x93 mm
Flux	660lm	Body Colors	White ; Black ; Grey
Beam Angle	90°	Dimmable	NO
Shape	Round		

WHITE			
SKU: 7496	Neutral White	4000K	3800156674967
SKU: 7493	Warm White	3000K	3800156674936
BLACK			
SKU: 7497	Neutral White	4000K	3800156674974
SKU: 7494	Warm White	3000K	3800156674943
GREY			
SKU: 7498	Neutral White	4000K	3800156674981
SKU: 7495	Warm White	3000K	3800156674950



**LED STEP LIGHT
2W Round**

Product code	WL2-A5	CRI	Ra>80
Watts	2W	IP Rating	IP65
Input Voltage	AC : 220-240V	Dimension	ø150x27 mm
Flux	80lm	Body Color	BLACK
Beam Angle	55°	Dimmable	NO
Shape	Round		

SKU: 7504 Neutral White 4200K 3800156675049
SKU: 7503 Warm White 3000K 3800156675032

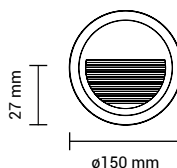

**LED STEP LIGHT
2W Square**

Product code	WL2-A5	CRI	Ra>80
Watts	2W	IP Rating	IP65
Input Voltage	AC : 220-240V	Dimension	124x124x27mm
Flux	80lm	Body Color	BLACK
Beam Angle	55°	Dimmable	NO
Shape	Square		

SKU: 7510 Neutral White 4200K 3800156675100
SKU: 7509 Warm White 3000K 3800156675094

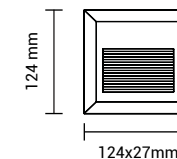

**LED STEP LIGHT
2W Round**

Product code	WL2-A5	CRI	Ra>80
Watts	2W	IP Rating	IP65
Input Voltage	AC : 220-240V	Dimension	ø150x27 mm
Flux	80lm	Body Color	WHITE
Beam Angle	55°	Dimmable	NO
Shape	Round		

SKU: 7506 Neutral White 4200K 3800156675063
SKU: 7505 Warm White 3000K 3800156675056

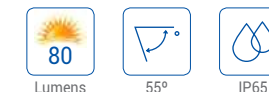
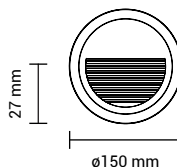

**LED STEP LIGHT
2W Square**

Product code	WL2-A5	CRI	Ra>80
Watts	2W	IP Rating	IP65
Input Voltage	AC : 220-240V	Dimension	124x124x27mm
Flux	80lm	Body Color	WHITE
Beam Angle	55°	Dimmable	NO
Shape	Square		

SKU: 7512 Neutral White 4200K 3800156675124
SKU: 7511 Warm White 3000K 3800156675117

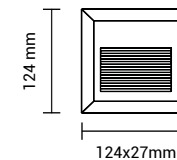

**LED STEP LIGHT
2W Round**

Product code	WL2-A5	CRI	Ra>80
Watts	2W	IP Rating	IP65
Input Voltage	AC : 220-240V	Dimension	ø150x27 mm
Flux	80lm	Body Color	GREY
Beam Angle	55°	Dimmable	NO
Shape	Round		

SKU: 7508 Neutral White 4200K 3800156675087
SKU: 7507 Warm White 3000K 3800156675070

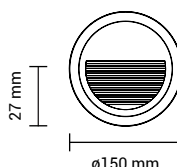

**LED STEP LIGHT
2W Square**

Product code	WL2-A5	CRI	Ra>80
Watts	2W	IP Rating	IP65
Input Voltage	AC : 220-240V	Dimension	124x124x27mm
Flux	80lm	Body Color	GREY
Beam Angle	55°	Dimmable	NO
Shape	Square		

SKU: 7514 Neutral White 4200K 3800156675148
SKU: 7513 Warm White 3000K 3800156675131

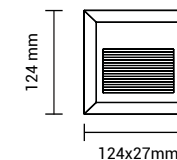

**LED STEP LIGHT
3W Rectangular**



Product code WL3-A5
 Watts 3W CRI Ra>80
 Input Voltage AC : 220-240V IP Rating IP65
 Flux 150lm Dimension 280x280x28 mm
 Beam Angle 65° Body Color BLACK
 Shape Rectangular Dimmable NO

SKU: 7516 Neutral White 4200K 3800156675162
 SKU: 7515 Warm White 3000K 3800156675155

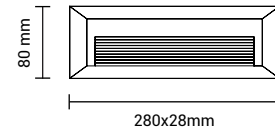

**LED STEP LIGHT
3W Round**



Product code WL3-A3
 Watts 3W CRI Ra>80
 Input Voltage AC : 220-240V IP Rating IP20
 Flux 90lm Dimension ø80x51 mm
 Beam Angle 34° Body Color WHITE
 Shape Round Dimmable NO

SKU: 7523 Neutral White 4200K 3800156675230
 SKU: 7522 Warm White 3000K 3800156675223

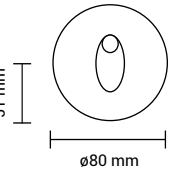

**LED STEP LIGHT
3W Rectangular**

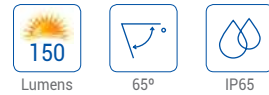

Product code WL3-A5
 Watts 3W CRI Ra>80
 Input Voltage AC : 220-240V IP Rating IP65
 Flux 150lm Dimension 280x280x28 mm
 Beam Angle 65° Body Color WHITE
 Shape Rectangular Dimmable NO

SKU: 7518 Neutral White 4200K 3800156675186
 SKU: 7517 Warm White 3000K 3800156675179

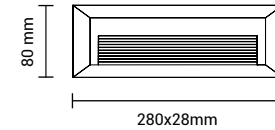

**LED STEP LIGHT
3W Square**



Product code WL3-A3
 Watts 3W CRI Ra>80
 Input Voltage AC : 220-240V IP Rating IP20
 Flux 90lm Dimension 80x80x51 mm
 Beam Angle 34° Body Color WHITE
 Shape Square Dimmable NO

SKU: 7525 Neutral White 4200K 3800156675254
 SKU: 7524 Warm White 3000K 3800156675247

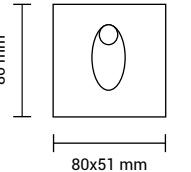

**LED STEP LIGHT
3W Rectangular**



Product code WL3-A5
 Watts 3W CRI Ra>80
 Input Voltage AC : 220-240V IP Rating IP65
 Flux 150lm Dimension 280x280x28 mm
 Beam Angle 65° Body Color GREY
 Shape Rectangular Dimmable NO

SKU: 7520 Neutral White 4200K 3800156675209
 SKU: 7519 Warm White 3000K 3800156675193

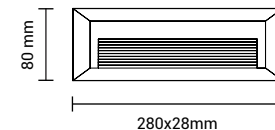

**LED STEP LIGHT
3W Square**



Product code WL3-A3
 Watts 3W CRI Ra>80
 Input Voltage AC : 220-240V IP Rating IP65
 Flux 195lm Dimension 84x27 mm
 Beam Angle 58° Body Color WHITE
 Shape Square Dimmable NO

SKU: 7521 Neutral White 4200K 3800156675216

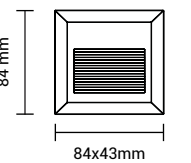

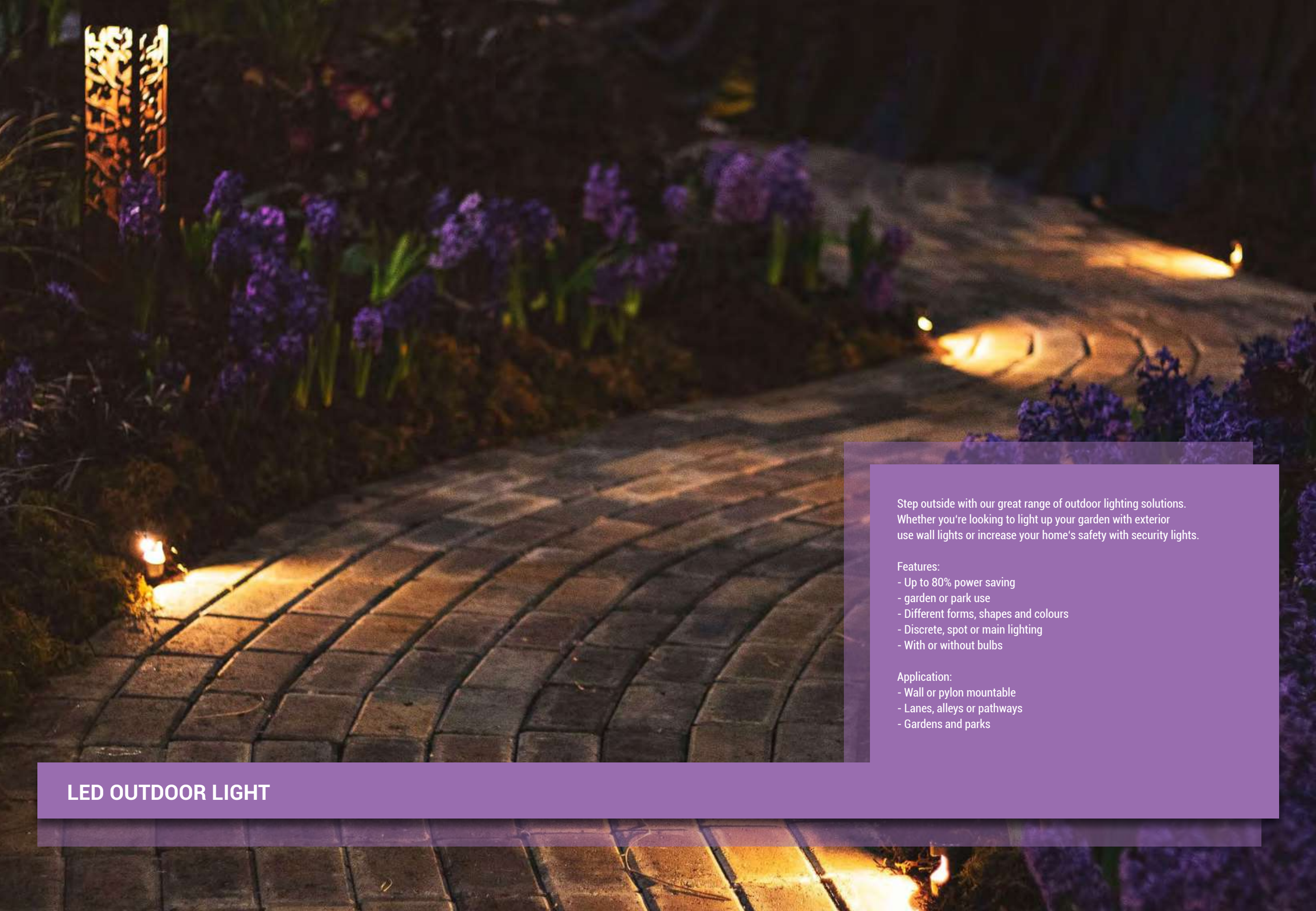

Step outside with our great range of outdoor lighting solutions. Whether you're looking to light up your garden with exterior use wall lights or increase your home's safety with security lights.

Features:

- Up to 80% power saving
- garden or park use
- Different forms, shapes and colours
- Discrete, spot or main lighting
- With or without bulbs

Application:

- Wall or pylon mountable
- Lanes, alleys or pathways
- Gardens and parks

LED OUTDOOR LIGHT



SKU: 7422 Stainless Steel 3800156674226



SKU: 7423 Stainless Steel 3800156674233

Wall Lamp Fitting
E27 Holder

Product code	WL1-A1	IP Rating	IP44
Socket	E27	Dimension	303x100x91 mm
Input Voltage	AC : 220-240V	Body Colors	Stainless Steel
Material	Aluminium	Max Power	16W



LED Wall Light Fitting
GU10 Socket

Product code	WL2-A3	IP Rating	IP44
Socket	GU10	Dimension	100x66x92 mm
Input Voltage	AC : 220-240V	Body Colors	Black ; White ; Silver
Material	Aluminium	Max Power	35W



SKU: 7443	Black Body	3800156674431
SKU: 7444	White Body	3800156674448
SKU: 7445	Silver Body	3800156674455



Wall Lamp Fitting
E27 Holder

Product code	WL1-A1	IP Rating	IP44
Socket	E27	Dimension	245x180x93 mm
Input Voltage	AC : 220-240V	Body Colors	Black ; White
Material	Aluminium+Glass	Max Power	60W



SKU: 7401	Black Body	3800156674011
SKU: 7402	White Body	3800156674028



LED Wall Light Fitting
Two GU10 Sockets

Product code	WL2-A4	IP Rating	IP44
Socket	2xGU10	Dimension	92x68x150 mm
Input Voltage	AC : 220-240V	Body Colors	Black ; White ; Silver
Material	Aluminium	Max Power	2x35W



SKU: 7446	Black Body	3800156674462
SKU: 7447	White Body	3800156674479
SKU: 7448	Silver Body	3800156674486



**LED Wall Light Fitting
GU10 Socket**

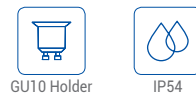

**LED Wall Light Fitting
GU10 Socket**

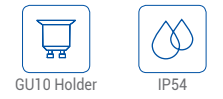

Product code	WL2-A1	IP Rating	IP54
Socket	GU10	Dimension	92x68x80 mm
Input Voltage	AC : 220-240V	Body Colors	Black ; White ; Silver ; Polished
Material	Aluminium	Max Power	35W

SKU: 7431	Black Body	3800156674318
SKU: 7432	White Body	3800156674325
SKU: 7433	Silver Body	3800156674332
SKU: 7449	Polished	3800156674493

Product code	WL2-A1	IP Rating	IP54
Socket	GU10	Dimension	100x66x92 mm
Input Voltage	AC : 220-240V	Body Colors	Black ; White ; Grey
Material	Aluminium	Max Power	35W

SKU: 7434	Black Body	3800156674349
SKU: 7435	White Body	3800156674356
SKU: 7436	Grey Body	3800156674363



**LED Wall Light Fitting
Two GU10 Sockets**

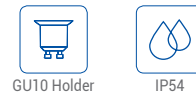

**LED Wall Light Fitting
Two GU10 Sockets**



Product code	WL2-A2	IP Rating	IP54
Socket	2xGU10	Dimension	92x68x150 mm
Input Voltage	AC : 220-240V	Body Colors	Black ; White ; Silver ; Polished
Material	Aluminium	Max Power	2x35W

SKU: 7437	Black Body	3800156674370
SKU: 7438	White Body	3800156674387
SKU: 7439	Silver Body	3800156674394
SKU: 7450	Polished	3800156674509

Product code	WL2-A2	IP Rating	IP54
Socket	2xGU10	Dimension	92x68x150 mm
Input Voltage	AC : 220-240V	Body Colors	Black ; White ; Grey
Material	Aluminium	Max Power	2x35W

SKU: 7440	Black Body	3800156674400
SKU: 7441	White Body	3800156674417
SKU: 7442	Grey Body	3800156674424

LED SOLAR POWER GARDEN LIGHT

NEW



LED Light Fixture GU10 Socket



Product code	WL2-A2	IP Rating	IP65
Socket	1xGU10	Dimension	92x68x150 mm
Input Voltage	AC : 220-240V	Body Colors	Black
Material	PC	Max Power	35W

SKU: 2084 GU10-Black 3800156620841



LED SOLAR LAMP 1.5W Lawn Light



Watts	1.5W	CRI	Ra>80
Voltage	6V	IP Rating	IP65
Flux	60lm	Material	Aluminium
Beam Angle	110°	Body Color	Black
Battery	1.2V/1500mAh	Dimension	168x75.5x340 mm

SKU: 9321	White Light	6000K	3800156693210
SKU: 9322	Warm White	3000K	3800156693227
SKU: 9323	Blue Light		3800156693234
SKU: 9324	Green Light		3800156693241

CHARGING TIME~(7-8) Hours
DETECTION RANGE~8±2m



LED SOLAR LAMP 0.75W Wall Light



Product code	WL2-A6	CRI	Ra>80
Watts	0.75W	IP Rating	IP54
Voltage	5.5V	Material	ABS+PC
Flux	110lm	Body Color	Black
Beam Angle	110°	Dimension	124x95x48mm
Battery	1200mAh		

SKU: 7405 White Light 6000K 3800156674059

CHARGING TIME~(7-8) Hours
DETECTION RANGE~8±2m



LED SOLAR LAMP 1.5W Wall Light



Product code	WL5-A6	CRI	Ra>80
Watts	1.5W	IP Rating	IP54
Voltage	7.4V	Material	ABS+PC
Flux	150lm	Body Color	Black
Beam Angle	110°	Dimension	196x115x45mm
Battery	1200mAh		

SKU: 7406 White Light 6000K 3800156674066

CHARGING TIME~(7-8) Hours
DETECTION RANGE~8±2m



**LED SOLAR LAMP
2W Wall Light**

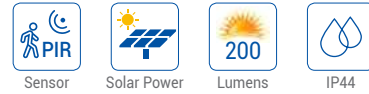

Product code	GD2-A1	CRI	Ra>80
Watts	2W	IP Rating	IP44
Voltage	3.7V	Material	Aluminium
Flux	200lm	Body Color	SS Brushed
Beam Angle	110°	Dimension	142x125x188mm
Battery	3.7V/1200mAh		

SKU: 9331 Warm White 3000K 3800156693319

CHARGING TIME~(7-8) Hours
DETECTION RANGE~8±2m



**LED SOLAR LAMP
4.4W Wall Light**

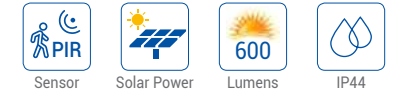

Product code	GD4-A1	CRI	Ra>80
Watts	4.4W	IP Rating	IP44
Voltage	3.7V	Material	Aluminium
Flux	600lm	Body Color	SS Brushed
Beam Angle	110°	Dimension	173x160x155mm
Battery	3.7V/2600mAh		

SKU: 9334 Warm White 3000K 3800156693340

CHARGING TIME~(7-8) Hours
DETECTION RANGE~8±2m



**LED SOLAR LAMP
2W Lawn Spike**

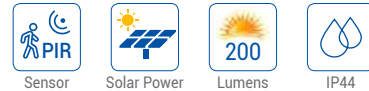

Product code	GD2-A1	CRI	Ra>80
Watts	2W	IP Rating	IP44
Voltage	3.7V	Material	Aluminium
Flux	200lm	Body Color	SS Brushed
Beam Angle	110°	Dimension	125x125x500mm
Battery	3.7V/1200mAh		

SKU: 9332 Warm White 3000K 3800156693326

CHARGING TIME~(7-8) Hours
DETECTION RANGE~8±2m



**LED SOLAR LAMP
4.4W Lawn Spike**

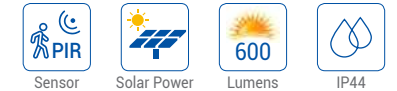

Product code	GD4-A1	CRI	Ra>80
Watts	4.4W	IP Rating	IP44
Voltage	3.7V	Material	Aluminium
Flux	600lm	Body Color	SS Brushed
Beam Angle	110°	Dimension	160x160x500mm
Battery	3.7V/2600mAh		

SKU: 9335 Warm White 3000K 3800156693357

CHARGING TIME~(7-8) Hours
DETECTION RANGE~8±2m



**LED SOLAR LAMP
2W Lawn Light**



Product code	GD2-A1	CRI	Ra>80
Watts	2W	IP Rating	IP44
Voltage	3.7V	Material	Aluminium
Flux	200lm	Body Color	SS Brushed
Beam Angle	110°	Dimension	125x125x800mm
Battery	3.7V/1200mAh		

SKU: 9333 Warm White 3000K 3800156693333

CHARGING TIME~(7-8) Hours
DETECTION RANGE~8±2m



**LED SOLAR LAMP
4.4W Lawn Light**

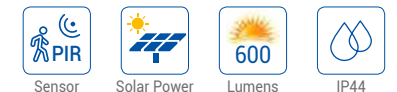

Product code	GD4-A1	CRI	Ra>80
Watts	4.4W	IP Rating	IP44
Voltage	3.7V	Material	Aluminium
Flux	600lm	Body Color	SS Brushed
Beam Angle	110°	Dimension	142x125x188mm
Battery	3.7V/2600mAh		

SKU: 9336 Warm White 3000K 3800156693364

CHARGING TIME~(7-8) Hours
DETECTION RANGE~8±2m

LED SOLAR LAMP
4.4W Wall Light



Product code	GD4-A1	CRI	Ra>80
Watts	4.4W	IP Rating	IP44
Voltage	3.7V	Material	Aluminium
Flux	600lm	Body Color	SS Brushed
Beam Angle	110°	Dimension	162x150x155mm
Battery	3.7V/2600mAh		

SKU: 9337 Warm White 3000K 3800156693371 CHARGING TIME~(7-8) Hours
DETECTION RANGE~8±2m

LED SOLAR LAMP
6W Wall Light

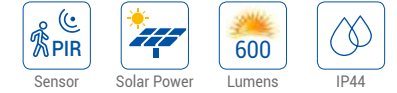

Product code	GD2-A2	CRI	Ra>80
Watts	6W	IP Rating	IP44
Voltage	3.7V	Material	Aluminium
Flux	600lm	Body Color	Black
Beam Angle	110°	Dimension	173x160x155mm
Battery	3.7V/2200mAh		

SKU: 9340 White Light 6000K 3800156693401 CHARGING TIME~(7-8) Hours
DETECTION RANGE~8±2m

LED SOLAR LAMP
4.4W Lawn Spike



Product code	GD4-A1	CRI	Ra>80
Watts	4.4W	IP Rating	IP44
Voltage	3.7V	Material	Aluminium
Flux	600lm	Body Color	SS Brushed
Beam Angle	110°	Dimension	150x150x500mm
Battery	3.7V/2600mAh		

SKU: 9338 Warm White 3000K 3800156693388 CHARGING TIME~(7-8) Hours
DETECTION RANGE~8±2m

LED SOLAR LAMP
6W Lawn Light 50cm

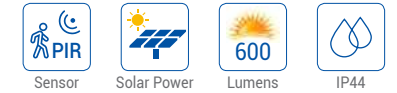

Product code	GD2-A2	CRI	Ra>80
Watts	6W	IP Rating	IP44
Voltage	3.7V	Material	Aluminium
Flux	600lm	Body Color	Black
Beam Angle	110°	Dimension	150x150x500mm
Battery	3.7V/2200mAh		

SKU: 9341 White Light 6000K 3800156693418 CHARGING TIME~(7-8) Hours
DETECTION RANGE~8±2m

LED SOLAR LAMP
4.4W Lawn Light



Product code	GD4-A1	CRI	Ra>80
Watts	4.4W	IP Rating	IP44
Voltage	3.7V	Material	Aluminium
Flux	600lm	Body Color	SS Brushed
Beam Angle	110°	Dimension	150x150x800mm
Battery	3.7V/2600mAh		

SKU: 9339 Warm White 3000K 3800156693395 CHARGING TIME~(7-8) Hours
DETECTION RANGE~8±2m

LED SOLAR LAMP
6W Lawn Light 90cm

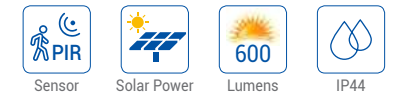

Product code	GD2-A2	CRI	Ra>80
Watts	6W	IP Rating	IP44
Voltage	3.7V	Material	Aluminium
Flux	600lm	Body Color	Black
Beam Angle	110°	Dimension	150x150x900mm
Battery	3.7V/2200mAh		

SKU: 9342 White Light 6000K 3800156693425 CHARGING TIME~(7-8) Hours
DETECTION RANGE~8±2m



**Wall Lamp Up
E27 Holder**



Product code	GD1-A1	IP Rating	IP44
Socket	E27	Dimension	215x170x220 mm
Input Voltage	AC : 220-240V	Body Colors	Black ; White
Material	Aluminium+PC	Max Power	60W

SKU: 9301	Black Body	3800156693012
SKU: 9302	White Body	3800156693029



**Stand Lamp
E27 Holder**



Product code	GD1-A2	IP Rating	IP44
Socket	E27	Dimension	170x170x290 mm
Input Voltage	AC : 220-240V	Body Colors	Black ; White
Material	Aluminium+PC	Max Power	60W

SKU: 9305	Black Body	3800156693050
SKU: 9306	White Body	3800156693067



**Wall Lamp Down
E27 Holder**



Product code	GD1-A1	IP Rating	IP44
Socket	E27	Dimension	215x170x220 mm
Input Voltage	AC : 220-240V	Body Colors	Black ; White
Material	Aluminium+PC	Max Power	60W

SKU: 9303	Black Body	3800156693036
SKU: 9304	White Body	3800156693043



**Ceiling Lamp
E27 Holder**



Product code	GD1-A3	IP Rating	IP44
Socket	E27	Dimension	170x170x740 mm
Input Voltage	AC : 220-240V	Body Colors	Black ; White
Material	Aluminium+PC	Max Power	60W

SKU: 9307	Black Body	3800156693074
SKU: 9308	White Body	3800156693081



**Lawn Lamp 60cm
E27 Holder**

Product code	GD1-A1	IP Rating	IP44
Socket	E27	Dimension	170x170x600 mm
Input Voltage	AC : 220-240V	Body Colors	Black ; White
Material	Aluminium+PC	Max Power	60W



E27 Holder



IP44

SKU: 9309 Black Body 3800156693098

SKU: 9310 White Body 3800156693104



**Lawn Lamp 90cm
E27 Holder**

Product code	GD1-A1	IP Rating	IP44
Socket	E27	Dimension	170x170x900 mm
Input Voltage	AC : 220-240V	Body Colors	Black ; White
Material	Aluminium+PC	Max Power	60W



E27 Holder



IP44

SKU: 9311 Black Body 3800156693111

SKU: 9312 White Body 3800156693128

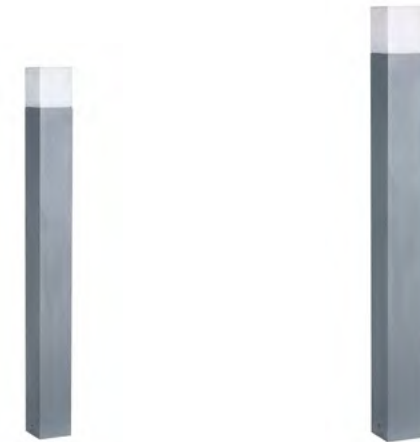

**Lawn Lamp
E27 Holder**

Product code	GD1-A7	IP Rating	IP54
Socket	E27	Dimension	76x76x800/1000 mm
Input Voltage	AC : 220-240V	Body Colors	Grey
Material	Aluminium+PC	Max Power	16W



E27 Holder



IP54

SKU: 9315 Grey Body 80cm 3800156693159

SKU: 9316 Grey Body 100cm 3800156693166



1W



7W

Powerful LED Pond Wall Lights
LED Light 1.3W ; 7W

Product code	UN1-A5	IP Rating	IP68
Power	1.3W ; 7W	Dimension	60 x 60 x 78 mm
Voltage	DC:24V		



SKU: 590	1W-Warm Light 3000K	3800156605909
SKU: 856	7W-Neutral Light 4000K	3800156608566



1W

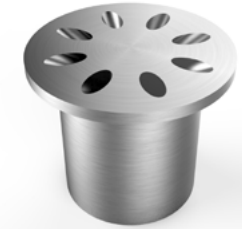

1.3W

Decorative Mini LED Pond Wall Lights
LED Light 1-1.3W

Product code	UN1-A6	IP Rating	IP68
Power	1W -1.3W	Dimension	35 x 28 mm
Voltage	DC:24V		



SKU: 591	RGB - 1W	3800156605916
SKU: 594	White Light 6000K	3800156605947
SKU: 595	Warm Light 3000K	3800156605954



Mini Wall & Floor Lights
LED Light 1.2W

Product code	UN1-A5	IP Rating	IP68
Power	1.2W	Dimension	38 x 30 mm
Voltage	DC:24V		



SKU: 586	White Light 6000K	3800156605862
SKU: 587	Warm Light 3000K	3800156605879
SKU: 588	Blue Light	3800156605886
SKU: 589	RGB Light	3800156605893



1W

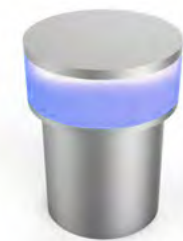

1.3W

Powerful LED Pond Wall Light
LED Light 1W-1.3W

Product code	UN1-A9	IP Rating	IP68
Power	1W-1.3W	Dimension	32 x 44 mm
Voltage	DC:24V		



SKU: 565	RGB Light 1W	3800156606562
SKU: 566	BLUE Light	3800156605879
SKU: 567	GREEN Light	3800156605886
SKU: 568	AMBER Light	3800156605893



1 Side Beam



2 Side Beam

Mini Directional Ground Lights
LED Light 1.3W

Product code	UN1-A8	IP Rating	IP68
Power	1.3W	Dimension	44 x 43 mm
Voltage	DC:24V		



SKU: 596	6000K 1 Side Beam	3800156605961
SKU: 597	3000K 1 Side Beam	3800156605978
SKU: 598	6000K 2 Side Beam	3800156605985
SKU: 599	3000K 2 Side Beam	3800156605992



1W



1.3W

LED Mini Floor Lights
LED Light 1-1.3W

Product code	UN1-A3	IP Rating	IP68
Power	1W -1.3W	Dimension	23 x 40 mm
Voltage	DC:24V		



SKU: 580	1W 6000K	3800156605800
SKU: 581	1W 3000K	3800156605817
SKU: 582	1W Blue Light	3800156605824
SKU: 583	1.3W 6000K	3800156605831
SKU: 584	1.3W 3000K	3800156605848
SKU: 585	1.3W Blue Light	3800156605855



LED Spike Lights
LED Light 1.3W

Product code	UN1-A5	IP Rating	IP68
Power	1.3W	Dimension	38 x 30 mm
Voltage	DC:24V		



Sleeve for LED Underground Lights

SKU: 873	Size - 22*55MM
SKU: 872	Size - 55*150MM
SKU: 874	Size - 35*150MM

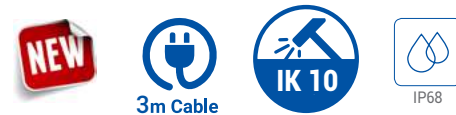

SKU: 866	White Light 6000K	3800156608665
SKU: 867	Neutral Light 4000K	3800156608672
SKU: 868	Warm Light 3000K	3800156608689



Mini Ground Lights
HALF-SHADING 1.3W

Product code	UN1-A6	IP Rating	IP68
Power	1.3W	Dimension	60 x 45 mm
Voltage	DC:24V		



SKU: 592	White Light 6000K	3800156605923
SKU: 593	Warm Light 3000K	3800156605930



Mini Recessed Wall Lights
LED Light 1W

Product code	UN1-A6	IP Rating	IP44
Power	1W	Dimension	64 x 43 mm
Voltage	DC:24V		



SKU: 863	White Light 6000K	3800156608634
SKU: 864	Neutral Light 4000K	3800156608641
SKU: 865	Warm Light 3000K	3800156608658
SKU: 879	Blue Light	3800156608795

NEW



**LED Pool Light
12W PAR56**



Product code	PL12-A1	CRI	Ra>80
Watts	12W	IP Rating	IP68
Input Voltage	AC/DC :12V	Dimension	ø178x114 mm
Flux	1200lm	Body	Glass
Beam Angle	90°	Dimmable	NO
Socket	PAR56		

SKU: 571 White Light 6000K 3800156605718
 SKU: 572 Warm White 2700K 3800156605725



NEW



With Remote

**LED Pool Light
12W PAR56**

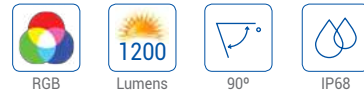

Product code	PL12-A1	CRI	Ra>80
Watts	12W	IP Rating	IP68
Input Voltage	AC/DC :12V	Dimension	ø178x114 mm
Flux	1200lm	Body	Glass
Beam Angle	90°	Dimmable	NO
Socket	PAR56		

SKU: 573 RGB 3800156605732



**LED Outdoor Light
1W Spotlight UN1-A1**

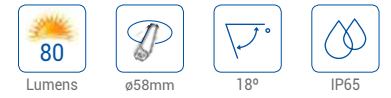

Watts	1W	CRI	Ra>80
Input Voltage	AC : 220-245V	IP Rating	IP65
Flux	80lm	Dimension	ø65x78mm
Beam Angle	18°	Body Color	Stainless steel

SKU: 507 White Light 6000K 3800156605077
 SKU: 517 Warm White 2800K 3800156605176

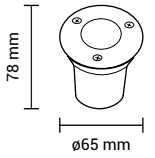

**LED Outdoor Light
3W Spotlight UN3-A1**

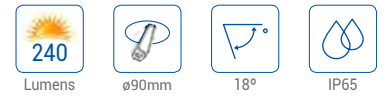

Watts	3W	CRI	Ra>80
Input Voltage	AC : 220-245V	IP Rating	IP65
Flux	240lm	Dimension	ø100x82mm
Beam Angle	18°	Body Color	Stainless steel

SKU: 501 White Light 6000K 3800156605015
 SKU: 502 Warm White 2800K 3800156605022

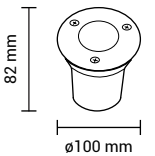

**LED Outdoor Light
5W Spotlight UN5-A1**

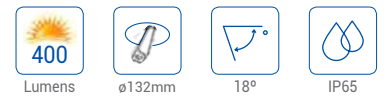

Watts	5W	CRI	Ra>80
Input Voltage	AC : 220-245V	IP Rating	IP65
Flux	400lm	Dimension	ø140x93 mm
Beam Angle	18°	Body Color	Stainless steel

SKU: 515 White Light 6000K 3800156605152
 SKU: 516 Warm White 2800K 3800156605169

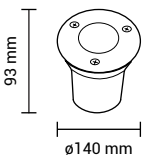

**LED Outdoor Light
7W Spotlight UN7-A1**

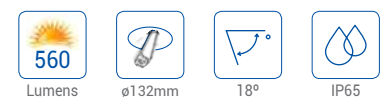

Watts	7W	CRI	Ra>80
Input Voltage	AC : 220-245V	IP Rating	IP65
Flux	560lm	Dimension	ø150x93 mm
Beam Angle	18°	Body Color	Stainless steel

SKU: 550 White Light 6000K 3800156605503
 SKU: 551 Warm White 2800K 3800156605510

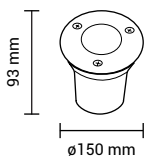



Outdoor String Lights

E27 Holders OT1-A3

- * 6 or 14.4 Meters Long String
- * 10 or 15 Pcs E27 Sockets
- * Up to 5A
- * Suspended Sockets
- * IP65
- * Black Color

SKU: 5054 10pcs E27 - 6m 3800156650541
 SKU: 5051 15pcs E27 - 14.4m 3800156650510



E27 Holder



IP65



Outdoor String Lights

Colourful Bulbs

- * 8 or 13 Meters Long String
- * 10 or 20 Bulbs included
- * 0.5 Watts Per Bulb
- * IP65
- * Black Color

SKU: 5056 10pcs Bulbs - 8m - 3W Colourful Bulbs 3800156650565
 SKU: 5092 20pcs Bulbs - 13m - 6W Colourful Bulbs 3800156650923



IP65



Linkable up to 2 Strings



Outdoor String Lights

E27 Holders OT1-A3

- * 6 or 14.4 Meters Long String
- * 10 or 15 Pcs E27 Sockets
- * Up to 5A
- * Fixed Sockets
- * IP65
- * White Color

SKU: 5055 10pcs E27 - 6m 3800156650558
 SKU: 5053 15pcs E27 - 14.4m 3800156650534



E27 Holder



IP65



Outdoor String Lights

Colourful Bulbs

- * 8 or 13 Meters Long String
- * 10 or 20 Bulbs included
- * 0.5 Watts Per Bulb
- * IP65
- * White Color

SKU: 5090 10pcs Bulbs - 8m - 3W Colourful Bulbs 3800156650909
 SKU: 5095 20pcs Bulbs - 13m - 6W Colourful Bulbs 3800156650954



IP65



Linkable up to 2 Strings



Outdoor String Lights

E27 Holders OT1-A3

- * 14.4 Meters Long String
- * 15 Pcs E27 Sockets
- * Up to 5A
- * Fixed Sockets
- * IP65
- * Black Color

SKU: 5052 15pcs E27 - 14.4m 3800156650527



E27 Holder



IP65



Outdoor String Lights

With Bulbs

- * 8 or 13 Meters Long String
- * 10 or 20 Bulbs included
- * 0.5 Watts Per Bulb
- * IP65
- * Black Color

SKU: 5057 10pcs Bulbs - 8m - 3W 6000K 3800156650572
 SKU: 5058 10pcs Bulbs - 8m - 3W 2700K 3800156650589
 SKU: 5093 20pcs Bulbs - 13m - 6W 6000K 3800156650930
 SKU: 5094 20pcs Bulbs - 13m - 6W 2700K 3800156650947



IP65



Linkable up to 2 Strings



Outdoor String Lights

With Bulbs

- * 8 or 13 Meters Long String
- * 10 or 20 Bulbs included
- * 0.5 Watts Per Bulb
- * IP65
- * White Color

SKU: 5091 10pcs Bulbs - 8m - 3W 2700K 3800156650916
 SKU: 5096 20pcs Bulbs - 13m - 6W 2700K 3800156650961



IP65



Linkable up to 2 Strings



A universe of possibilities when combining the existing lighting solutions with various detecting devices to further enable energy saving and efficiency.

Features:

- Up to 80% power saving
- Home, office, garden or park use
- Different forms, shapes and colours
- Easy installation and long lifecycle

Application:

- Wall or pylon mountable

MOTION SENSORS

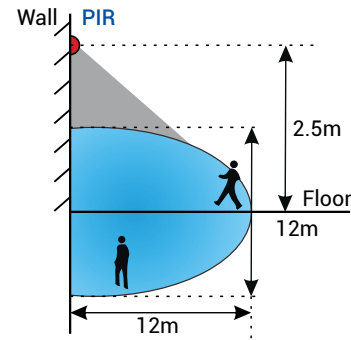

PIR Motion Sensor

Product code	SE1-A1	Body Color	White
Input Voltage	AC:110-240V	Class	II
Beam Angle	180°	Time	10sec-7min
Range	12m Max	Max Power	300W LED
Frequency	50-60 Hz	Ambient Light	<10Lux-2000Lux
Working Temp.	-30°C/+50°C	Material	Plastic+ALU
IP Rating	IP44	Dimension	ø65x86.5mm



SKU: 7301 White Body 3800156673014

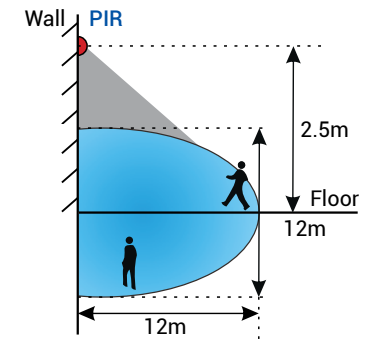

PIR Motion Sensor

Product code	SE1-A3	Body Color	White
Input Voltage	AC:110-240V	Class	II
Beam Angle	180°	Time	10sec-7min
Range	12m Max	Max Power	200W LED
Frequency	50-60 Hz	Ambient Light	<10Lux-2000Lux
Working Temp.	-30°C/+50°C	Material	Plastic+ALU
IP Rating	IP54	Dimension	ø77x70mm

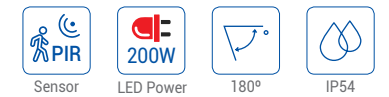

SKU: 7306 White Body 3800156673069

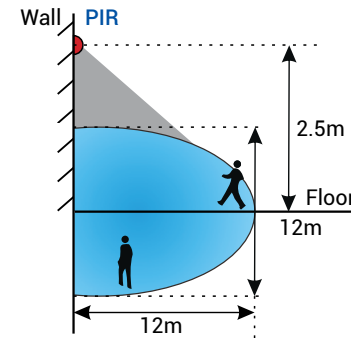

PIR Motion Sensor

Product code	SE1-A1	Body Color	Black
Input Voltage	AC:110-240V	Class	II
Beam Angle	180°	Time	10sec-7min
Range	12m Max	Max Power	300W LED
Frequency	50-60 Hz	Ambient Light	<10Lux-2000Lux
Working Temp.	-30°C/+50°C	Material	Plastic+ALU
IP Rating	IP44	Dimension	ø65x86.5mm



SKU: 7302 Black Body 3800156673021

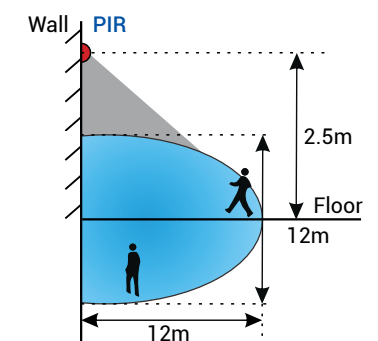

PIR Motion Sensor

Product code	SE1-A3	Body Color	Black
Input Voltage	AC:110-240V	Class	II
Beam Angle	180°	Time	10sec-7min
Range	12m Max	Max Power	200W LED
Frequency	50-60 Hz	Ambient Light	<10Lux-2000Lux
Working Temp.	-30°C/+50°C	Material	Plastic+ALU
IP Rating	IP54	Dimension	ø77x70mm

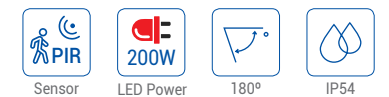

SKU: 7307 Black Body 3800156673076

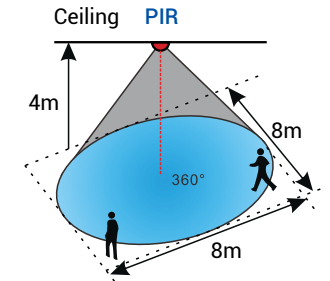
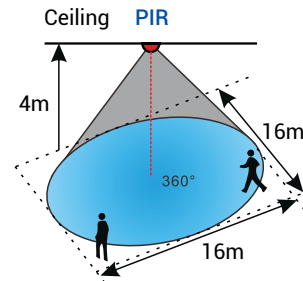

PIR Motion Sensor

Product code	SE1-A2	Body Color	White
Input Voltage	AC:110-240V	Class	II
Beam Angle	360°	Time	10sec-7min
Range	16m Max	Max Power	300W LED
Frequency	50-60 Hz	Ambient Light	<10Lux-2000Lux
Working Temp.	-30°C/+50°C	Material	Plastic+ALU
IP Rating	IP20	Dimension	∅88x55.5mm



SKU: 7305 White Body 3800156673052

PIR Motion Sensor

Product code	SE1-A2	Body Color	White
Input Voltage	AC:110-240V	Class	II
Beam Angle	360°	Time	10sec-7min
Range	8m Max	Max Power	1000W LED
Frequency	50-60 Hz	Ambient Light	<10Lux-2000Lux
Working Temp.	-30°C/+50°C	Material	Plastic+ALU
IP Rating	IP20	Dimension	∅108x25mm



SKU: 7310 White Body 3800156673106

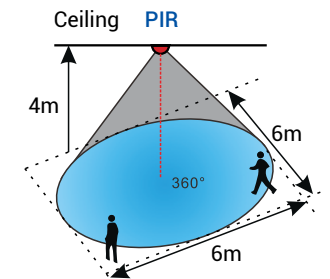
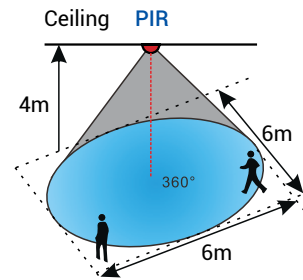

PIR Motion Sensor

Product code	SE1-A2	Body Color	White
Input Voltage	AC:220-240V	Class	II
Beam Angle	360°	Time	10sec-7min
Range	6m Max	Max Power	300W LED
Frequency	50-60 Hz	Ambient Light	<10Lux-2000Lux
Working Temp.	-30°C/+50°C	Material	Plastic+ALU
IP Rating	IP20	Dimension	∅76x58mm



SKU: 7317 White Body 3800156673175
 SKU: 7320 Black Body 3800156673205
 SKU: 7321 Gray Body 3800156673212

PIR Motion Sensor

Product code	SE1-A2	Body Color	White
Input Voltage	AC:110-240V	Class	II
Beam Angle	360°	Time	10sec-7min
Range	6m Max	Max Power	1000W LED
Frequency	50-60 Hz	Ambient Light	<10Lux-2000Lux
Working Temp.	-30°C/+50°C	Material	Plastic+ALU
IP Rating	IP20	Dimension	∅65x86.5mm



SKU: 7311 White Body 3800156673113

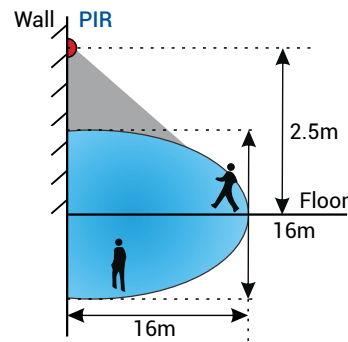

PIR Motion Sensor

Functions: D2D: DUSK TO DAWN

Product code	SE1-A2	Body Color	Black
Input Voltage	AC:220-240V	Class	II
Beam Angle	180°	Time	10sec-10min
Range	16m Max	Max Power	400W LED
Frequency	50-60 Hz	Ambient Light	<10Lux-2000Lux
Working Temp.	-30°C/+50°C	Material	Plastic+ALU
IP Rating	IP54		

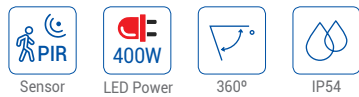

SKU: 7318 Black Body 3800156673182

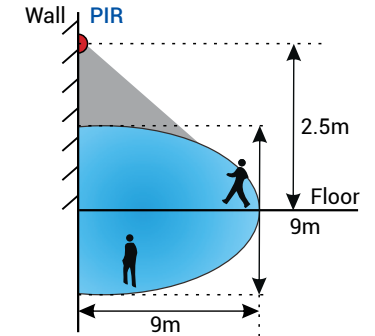

PIR Motion Sensor

Product code	SE1-A2	Body Color	White
Input Voltage	AC:220-240V	Class	II
Beam Angle	160°	Time	10sec-7min
Range	9m Max	Max Power	400W LED
Frequency	50-60 Hz	Ambient Light	<10Lux-2000Lux
Working Temp.	-30°C/+50°C	Material	Plastic+ALU
IP Rating	IP20		



SKU: 7322 White Body 3800156673229

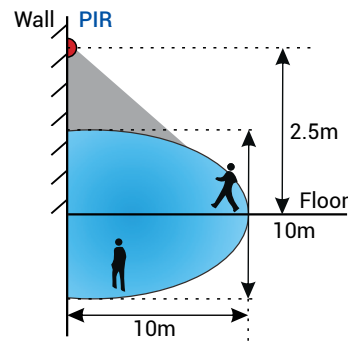

PIR Motion Sensor

Product code	SE1-A2	Body Color	White
Input Voltage	AC:220-240V	Class	II
Beam Angle	120°	Time	10sec-7min
Range	10m Max	Max Power	300W LED
Frequency	50-60 Hz	Ambient Light	<10Lux-2000Lux
Working Temp.	-30°C/+50°C	Material	Plastic+ALU
IP Rating	IP44		

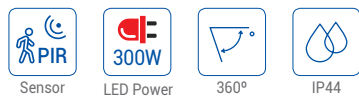

SKU: 7319 White Body 3800156673199

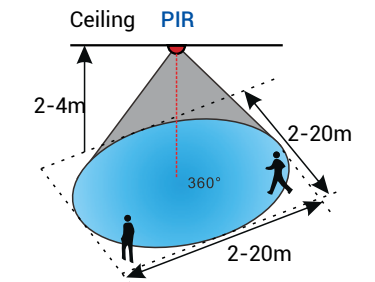

PIR Motion Sensor

Product code	SE1-A2	Body Color	White
Input Voltage	AC:220-240V	Class	II
Beam Angle	360°	Time	5sec-10min
Range	20m Max	Max Power	1000W LED
Frequency	50-60 Hz	Ambient Light	<10Lux-2000Lux
Working Temp.	-30°C/+50°C	Material	Plastic+ALU
IP Rating	IP20	Dimension	ø65x86.5mm



SKU: 7323 White Body 3800156673236



ON/OFF via moving hand



Dimming + Driver
5.8 Ghz

Short Distance IR

Product code	SE1-A2	Body Color	White
Input Voltage	AC:110-240V	Class	II
Beam Angle	180°	Time	10sec-7min
Range	5cm Max	Max Power	200W LED
Frequency	50-60 Hz	Ambient Light	<10Lux-2000Lux
Working Temp.	-30°C/+50°C	Material	Plastic
IP Rating	IP20	Dimension	75x18mm



SKU: 7304 White Body 3800156673045

Microwave Sensor

Product code	SE1-A5	Body Color	White
Input Voltage	AC:110-240V	Class	II
Beam Angle	180°/ 300°	Time	10sec-30min
Range	25-100%	Max Power	300W LED
Frequency	50-60 Hz	Ambient Light	5,10,20,30,50,100,200lux
Working Temp.	-30°C/+50°C	Material	Plastic+ALU
IP Rating	IP20	Dimension	75x47mm



SKU: 7315 White Body 3800156673151

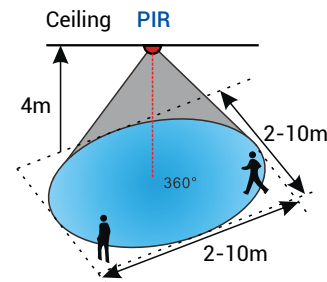

PIR Motion Sensor

Product code	SE1-A4	Body Color	White
Input Voltage	AC:110-240V	Class	II
Beam Angle	120°	Time	10sec-7min
Range	2-10m Max	Max Power	100W LED
Frequency	50-60 Hz	Ambient Light	<10Lux-2000Lux
Working Temp.	-30°C/+50°C	Material	Plastic+ALU
IP Rating	IP65	Dimension	57x35mm



SKU: 7309 White Body 3800156673090



Dimming + Driver
5.8 Ghz

Microwave Sensor

Product code	SE1-A5	Body Color	White
Input Voltage	AC:110-240V	Class	II
Beam Angle	180°	Time	10sec-7min
Range	3-10m Max	Max Power	300W LED
Frequency	50-60 Hz	Ambient Light	<10Lux-2000Lux
Working Temp.	-30°C/+50°C	Material	Plastic+ALU
IP Rating	IP20	Dimension	56x42mm



SKU: 7316 White Body 3800156673168

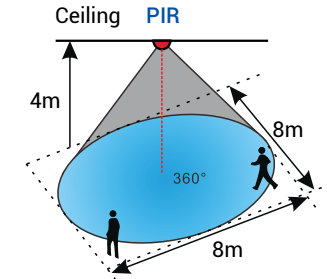

PIR Motion Sensor

Product code	SE1-A2	Body Color	White
Input Voltage	AC:110-240V	Class	II
Beam Angle	360°	Time	10sec-7min
Range	8m Max	Max Power	300W LED
Frequency	50-60 Hz	Ambient Light	<10Lux-2000Lux
Working Temp.	-30°C/+50°C	Material	Plastic+ALU
IP Rating	IP20	Dimension	∅80x62mm



SKU: 7312 White Body 3800156673120

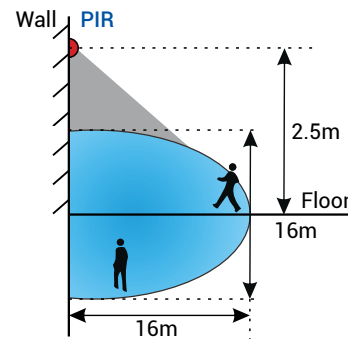

PIR Motion Sensor

Product code	SE1-A1	Body Color	White
Input Voltage	AC:110-240V	Class	II
Beam Angle	300°	Time	10sec-7min
Range	16m Max	Max Power	300W LED
Frequency	50-60 Hz	Ambient Light	<10Lux-2000Lux
Working Temp.	-30°C/+50°C	Material	Plastic+ALU
IP Rating	IP44	Dimension	165x117mm



SKU: 7313 White Body 3800156673137



Light Control Sensor

Product code	SE1-A1	Body Color	White+Blue
Input Voltage	AC:110-240V	Class	II
Power	6A Max	Ambient Light	<10Lux ON; >40Lux OFF
Frequency	50-60 Hz	Material	Plastic+ALU
Working Temp.	-30°C/+50°C	Dimension	46x44x35mm
IP Rating	IP44		



SKU: 7314 White Body 3800156673144

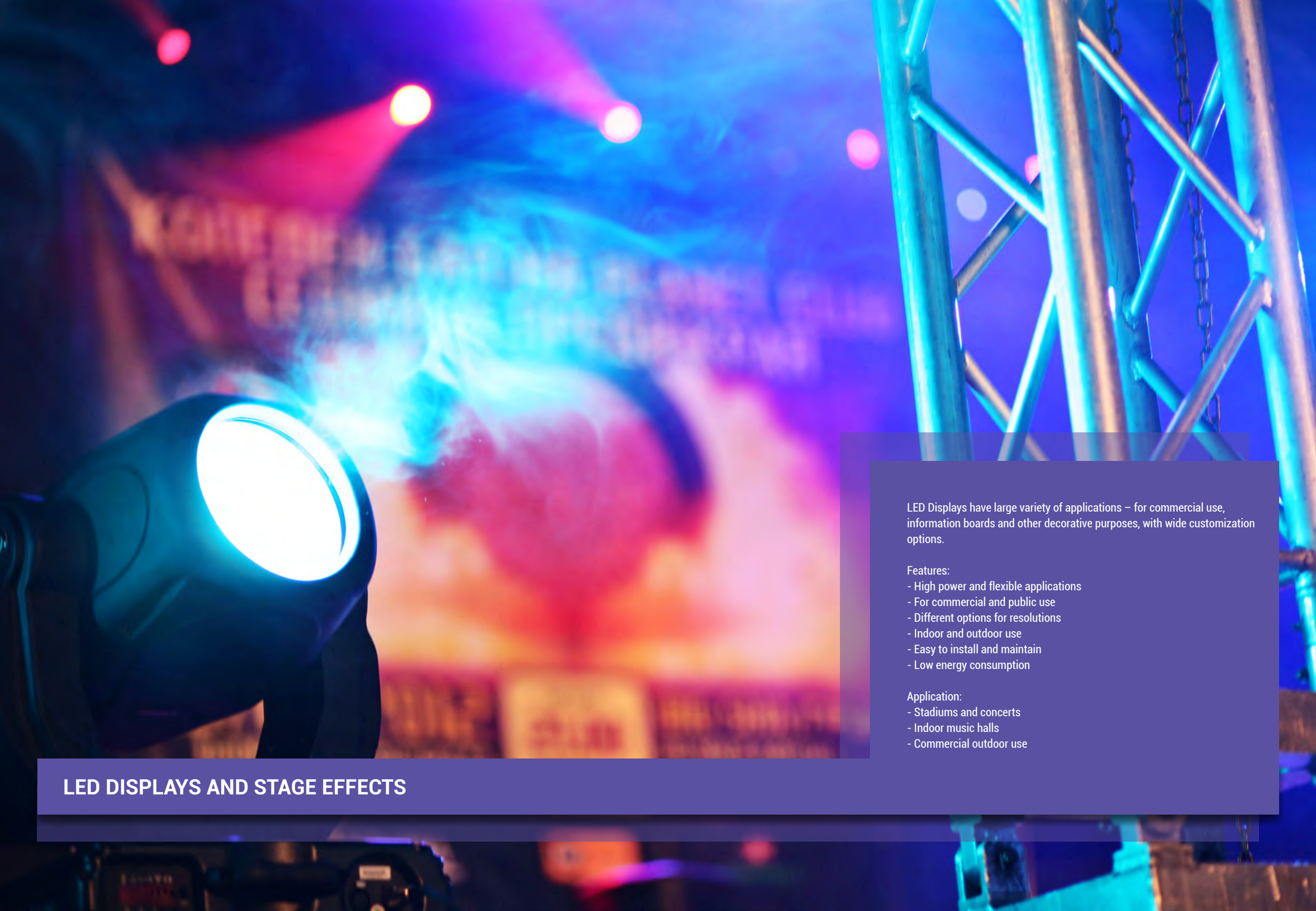

LED Displays have large variety of applications – for commercial use, information boards and other decorative purposes, with wide customization options.

Features:

- High power and flexible applications
- For commercial and public use
- Different options for resolutions
- Indoor and outdoor use
- Easy to install and maintain
- Low energy consumption

Application:

- Stadiums and concerts
- Indoor music halls
- Commercial outdoor use

LED DISPLAYS AND STAGE EFFECTS



LED Displays

Module Indoor

- NEW** SKU: 608 P2Size 3800156606081
- SKU: 630 P2.5Size 3800156606302
- SKU: 631 P3 Size 3800156606319
- SKU: 601 P4 Size 3800156606012
- SKU: 602 P5 Size 3800156606029



	P2	P2.5	P3	P4	P5
Pixel pitch	2 mm	2.5 mm	3 mm	4 mm	5 mm
Module size	256x128 mm	320x160 mm	192x192 mm	256x128 mm	320x160 mm
Module pixels	128x64 pixel	128x32 pixel	64x64 pixel	64x32 pixel	64x32 pixel
Brightness	2000cd/m ²	1200cd/m ²	1100cd/m ²	1100cd/m ²	2000cd/m ²
Refresh rate	1920 Hz	1920 Hz	1920 Hz	1920 Hz	1920 Hz
Drive mode	1/32 Scan	1/32 Scan	1/32 Scan	1/16 Scan	1/16 Scan
Module Power	16.5W	20W	16.5W	16.5W	17W
Working Temp.	-20°C/+50°C	-20°C/+50°C	-20°C/+50°C	-20°C/+50°C	-20°C/+50°C
Pixel Composition	SMD 3in1 RGB	SMD 3in1 RGB	SMD 3in1 RGB	SMD 3in1 RGB	SMD 3in1 RGB
Life Span	50 000 h	50 000 h	50 000 h	50 000 h	50 000 h



LED Display Cabinet
Fix INDOOR Ver 2.0

- SKU: 610 P3 Size 3800156606104
- SKU: 611 P4 Size 3800156606111
- SKU: 612 P5 Size 3800156606128

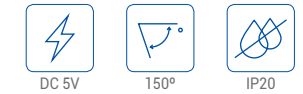

	P3	P4	P5
Pixel pitch	3 mm	4 mm	5 mm
Display size	960x960mm	768x768mm	960x960mm
Module size	192x192mm	256x128mm	320x192mm
Brightness	2000cd/m ²	2000cd/m ²	2000cd/m ²
Pixel Density	111 111dots/ m ²	62 500dots/ m ²	40 000dots/ m ²
Drive mode	1/32 Scan	1/16 Scan	1/16 Scan
Refresh rate	1920 Hz	1920 Hz	1920 Hz
Working Temp.	-20°C/+50°C	-20°C/+50°C	-20°C/+50°C
MAX Power	750W	750W	750W
Life Span	50 000 h	50 000 h	50 000 h

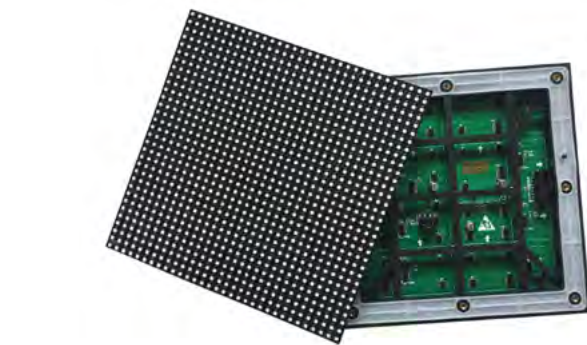

LED Displays

Module Outdoor

- NEW** SKU: 609 P3 Size 3800156606098
- SKU: 603 P4 Size 3800156606036
- SKU: 604 P5 Size 3800156606043
- SKU: 606 P6 Size 3800156606050
- SKU: 605 P8 Size 3800156606067



	P3	P4	P5	P6	P8
Pixel pitch	3 mm	4 mm	5 mm	6 mm	8 mm
Module size	192x192 mm	256x128 mm	320x160 mm	196x196 mm	256x128 mm
Module pixels	64x64pixel	64x32pixel	64x32 pixel	32x32 pixel	32x16 pixel
Brightness	6500cd/m ²	5500cd/m ²	5500cd/m ²	5500cd/m ²	5500cd/m ²
Refresh rate	1920 Hz	1920 Hz	1920 Hz	1920 Hz	1920 Hz
Drive mode	1/16 Scan	1/16 Scan	1/16 Scan	1/16 Scan	1/4 Scan
Module Power	35W	35W	39W	26W	27W
Working Temp.	-20°C/+50°C	-20°C/+50°C	-20°C/+50°C	-20°C/+50°C	-20°C/+50°C
Pixel Composition	SMD 3in1 RGB	SMD 3in1 RGB	SMD 3in1 RGB	SMD 3in1 RGB	SMD 3in1 RGB
Life Span	50 000 h	50 000 h	50 000 h	50 000 h	50 000 h



LED Display Cabinet
Fix INDOOR Ver 2.0

- SKU: 638 P3 Size 3800156606388
- SKU: 639 P4 Size 3800156606395
- SKU: 640 P5 Size 3800156606401



	P3	P4	P5
Pixel pitch	3 mm	4 mm	5 mm
Display size	960x960mm	768x768mm	960x960mm
Module size	192x192mm	256x128mm	320x192mm
Brightness	2000cd/m ²	2000cd/m ²	2000cd/m ²
Pixel Density	111 111dots/ m ²	62 500dots/ m ²	40 000dots/ m ²
Drive mode	1/32 Scan	1/16 Scan	1/16 Scan
Refresh rate	1920 Hz	1920 Hz	1920 Hz
Working Temp.	-20°C/+50°C	-20°C/+50°C	-20°C/+50°C
MAX Power	750W	750W	750W
Life Span	50 000 h	50 000 h	50 000 h



LED Display Cabinet
Fix OUTDOOR

- SKU: 617 P4 Size 3800156606173
- SKU: 618 P5 Size 3800156606180
- SKU: 619 P8 Size 3800156606197
- SKU: 607 P10 Size 3800156606074



	P4	P5	P8	P10
Pixel pitch	5 mm	5 mm	8 mm	10 mm
Display size	768x768mm	960x960mm	768x768mm	960x960mm
Module size	256x128mm	160x160mm	256x128mm	160x160mm
Brightness	5500cd/m ²	5500cd/m ²	5500cd/m ²	7500cd/m ²
Pixel Density	62 500dots/ m ²	40 000dots/ m ²	15 625dots/ m ²	40 000dots/ m ²
Drive mode	1/8 Scan	1/8 Scan	1/8 Scan	1/8 Scan
Refresh rate	1920 Hz	1920 Hz	1920 Hz	1920 Hz
Working Temp.	-20°C/+50°C	-20°C/+50°C	-20°C/+50°C	-20°C/+50°C
MAX Power	800W	800W	800W	800W
Life Span	50 000 h	50 000 h	50 000 h	50 000 h



LED Displays
Rental INDOOR

- SKU: 620 P2.5 Size 3800156606203
- SKU: 613 P4 Size 3800156606135
- SKU: 614 P5 Size 3800156606142



	P2.5	P4	P5
Pixel pitch	2.5 mm	4 mm	5 mm
Display size	640x640mm	768x768mm	960x960mm
Module size	160x160mm	256x128mm	320x160mm
Brightness	2000cd/m ²	2000cd/m ²	2000cd/m ²
Pixel Density	160 000dots/ m ²	62 500dots/ m ²	40 000dots/ m ²
Drive mode	1/16 Scan	1/16 Scan	1/16 Scan
Port Type	HUB75	HUB75	HUB75
Working Temp.	-20°C/+50°C	-20°C/+50°C	-20°C/+50°C
MAX Power	600W	600W	750W
Life Span	50 000 h	50 000 h	50 000 h

P3.91



P5



	P3.91	P5
Pixel pitch	3.91 mm	5 mm
Display size	500x1000mm	960x960mm
Module size	250x250mm	320x160mm
Brightness	6500cd/m ²	7500cd/m ²
Pixel Density	65 532dots/ m ²	40 000dots/ m ²
Drive mode	1/16 Scan	1/8 Scan
Port Type	HUB75	HUB75
Working Temp.	-20°C/+50°C	-20°C/+50°C
MAX Power	800W	750W
Life Span	50 000 h	50 000 h

LED Displays
Rental OUTDOOR

- NEW** SKU: 615 P3.91 Size 3800156606159
- SKU: 616 P5 Size 3800156606166

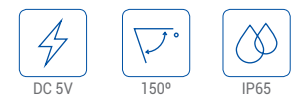



**LED Display Screen
OUTDOOR STADIUM**

SKU: 665 P5 Size 3800156673120
SKU: 622 P10 Size 3800156673120



	P5	P10
Pixel pitch	5 mm	10 mm
Module size	320x160mm	320x160mm
Module pixels	64x32 pixel	32x16 pixel
Brightness	7500cd/m ²	7500cd/m ²
Pixel Density	40 000dots/ m ²	10 000dots/ m ²
Drive mode	1/8 Scan	1/4 Scan
Port Type	HUB75	HUB75
Working Temp.	-20°C/+50°C	-20°C/+50°C
MAX Power	700W	700W
Life Span	50 000 h	50 000 h



**LED Displays
STAGE FLOOR**

SKU: 802 P3.91 Size 3800156673120
SKU: 803 P4.81 Size 3800156673120
SKU: 804 P5.95 Size 3800156673120



	P3.91	P4.81	P5.95
Pixel pitch	3.91 mm	4.81 mm	5.95 mm
Module size	250x250 mm	250x250 mm	250x250mm
Module pixels	64x64 pixel	52x52 pixel	42x42pixel
Brightness	7500cd/m ²	7500cd/m ²	7500cd/m ²
Pixel Density	65 536dots/m ²	43 264dots/m ²	28 224dots/m ²
Drive mode	1/8 Scan	1/13 Scan	1/8Scan
Port Type	HUB75	HUB75	HUB75
Working Temp.	-20°C/+50°C	-20°C/+50°C	-20°C/+50°C
MAX Power	700W	700W	700W
Life Span	50 000 h	50 000 h	50 000 h



**LED Displays
INDOOR Poster Display**

SKU: 805 P2.5 Size 3800156673120
SKU: 621 P3 Size 3800156606210
SKU: 806 P4 Size 3800156673120



	P2.5	P3	P4
Pixel pitch	2.5 mm	3 mm	4 mm
Module size	320x160 mm	192x192 mm	256x128 mm
Module pixels	128x64 pixel	64x64 pixel	64x32 pixel
Brightness	2000cd/m ²	2000cd/m ²	2000cd/m ²
Pixel Density	160 000dots/ m ²	111 111dots/ m ²	62 500dots/ m ²
Drive mode	1/32 Scan	1/32 Scan	1/32 Scan
Port Type	HUB75	HUB75	HUB75
Working Temp.	-20°C/+50°C	-20°C/+50°C	-20°C/+50°C
Pixel Composition	SMD 3in1 RGB	SMD 3in1 RGB	SMD 3in1 RGB
Life Span	100 000 h	100 000 h	100 000 h



**LED DISPLAYS
43 inch IR touch**

SKU: 671 43inch 3800156673120
CPU: Bay Trail-D Celeron Quad-core J1900 2.0GHZ
Chipset: Intel Bay trail SOC
GPU Integrate: Intel HD Graphics
Display output : VGA, built-in VGA pin, HDMI, HDMI pin, LVDS
Memory: DDR3 2GB
Hard drive: 32G Hard drive



**LED DISPLAYS
43 inch capacitive touch**

SKU: 673 43inch 3800156673120
CPU: Bay Trail-D Celeron Quad-core J1900 2.0GHZ
Chipset: Intel Bay trail SOC
GPU Integrate: Intel HD Graphics
Display output : VGA, built-in VGA pin, HDMI, HDMI pin, LVDS
Memory: DDR3 2GB
Hard drive: 32G Hard drive



**RECEIVING CARDS
FOR LED DISPLAYS**

- SKU: 950 3800156609501
- SKU: 652 3800156606319
- SKU: 653 3800156606012
- SKU: 654 3800156606319
- SKU: 655 3800156606012



SKU No.	950	652	653	654	655
Resolution	256 x 226	512 x 256	256 x 226	256 x 226	512x256
RGB Data Output	16 Groups	32 Groups	24 Groups	24 Groups	32 Groups
Interface	8 x HUB75	16 x HUB75	8 x HUB75	12 x HUB75	16 x HUB75

**Sending Box
LED Display Controller**

The Optonica Sender card control box is a sending card inside of an enclosure with a built in power supply. You can order the stand alone card if you do not need the enclosure.



- Product Type: Controller
- Capacity: 1.3 million pixels
- Supply Voltage: AC-100-240V-50/60HZ
- Control Method: USB Interface
- Video Interface: DVI
- Audio Interface: 3.5mm
- Viedo Format: RGB
- Output Interface : 2 Ethernet ports
- Bit Depth Of Video Resource: 8bit
- Light Sensor Interface: 1
- USB Cable: 1.5M



SKU: 948 3800156609488

**SENDING CARD
FOR LED DISPLAYS**

- SKU: 650 3800156606319
- SKU: 651 3800156606012



SKU No.	650	651
Input Resolutin	1280x1024,1024x1200,1600x848	1920x1200,2048x1152,2560x96
Capacity	1.3 million pixels	2.3 million pixels
Supply Voltage	5V	5V
Control Method	USB Interface	USB Interface
Video Interface	DVI	HDMI/DVI
Audio Interface	3.5mm	HDMI/3.5mm
Video Format	RGB	RGB ,YCrCb4:2:2,YCrCb4:4:4
Output Interface	2 Ethernet ports	4 Ethernet ports
Bit Depth	8bit	8/10/12bit

**Sending Box Synchronous
LED Display Controller**

supports extra-large resolution. With HDMI/DVI video input and four Ethernet port outputs, a single unit is able to load 2560x960. Multiple units can be cascaded for uniform control.



- Product specification: Product Type Controller
- Input Resolution: 1920x1200,2048x1152,2560x960
- Capacity: 2.3 million pixels
- Supply Voltage: AC-100-240V-50/60HZ
- Control Method: USB Interface
- Video Interface: HDMI / DVI
- Audio Interface: HDMI/3.5mm
- Viedo Format: RGB,YCrCb4:2:2,YCrCb4:4:4
- Output Interface: 4 Ethernet ports
- Bit Depth Of Video Resource: 8/10/12bit
- Light Sensor Interface: 1



SKU: 947 3800156609471



TB3 CONTROLLER

Multimedia Players

- Loading capacity up to 650,000 pixels, with the maximum width of 4096 pixels and maximum height of 1920 pixels
- Wired Gigabit Ethernet
- Stereo audio output
- 1 USB port allowing for USB playback
- Onboard light sensor connector allowing for automatic and scheduled brightness adjustment
- Synchronization mechanism for multi-screen playing
- Powerful processing capability
- Comprehensive control plans
- Dual-Wi-Fi mode
- Redundant backup



SKU: 660 3800156606609



IP20



TB8 CONTROLLER

Multimedia Player

- 4 Ethernet ports, loading capacity of each port up to 2,300,000 pixels, with the maximum width of 4096 pixels and maximum height of 1920 pixels
- Wired Gigabit Ethernet
- Stereo audio output
- HDMI Loop
- HDMI input and auto full-screen display
- 2 USB ports allowing for USB playback
- Onboard light sensor connector allowing for automatic and scheduled brightness adjustment synchronization mechanism for multi-screen playing
- Powerful processing capability
- Comprehensive control plans
- Synchronous and asynchronous dual-mode
- Dual-Wi-Fi mode



SKU: 946 3800156609464



IP20

TB6 CONTROLLER

Multimedia Players

- Loading capacity up to 1,300,000 pixels, with the maximum width of 4096 pixels and maximum height of 1920 pixels
- Wired Gigabit Ethernet
- Stereo audio output
- HDMI Loop
- HDMI input and auto full-screen display
- 2 USB ports allowing for USB playback
- Onboard light sensor connector allowing for automatic and scheduled brightness adjustment
- Synchronization mechanism for multi-screen playing
- Powerful processing capability
- Comprehensive control plans
- Synchronous and asynchronous dual-mode
- Dual-Wi-Fi mode
- Redundant backup



SKU: 661 3800156606616



IP20

LED Display Accessories

Splitter

DIS-300 is specialized for multi-screens and super large led screens. The card possesses two input ports and eight output ports, enabling that one split to eight and two split to four. Functions change automatically. Each RJ45 port can be independently adjusted, and support read back parameters from scan board.

Description:

- 1 in 8 out or 2 in 4 out, automatic switching.
- Each RJ45 port can be independently adjusted.
- No need to install the drivers



SKU: 952 3800156609525



IP20

ALL-IN-1 CONTROLLER
LED VIDEO PROCESSOR WITH SDI



Product Type : Video Controller
 Inputs : HDMI, DVI, VGA × 2, CVBS × 2, DP, SDI
 Outputs : Ethernet port × 4
 Loading Capacity : 2.35 million pixels
 Maximum pixel CLK : 165MHz
 Video Loop : DVI LOOP, SDI LOOP
 Video Monitor : VGA OUT, DVI OUT
 Communication Mode: USB/LAN
 Image Mosaic : Support
 Crop Settings : Support
 PIP : Support



SKU: 656 3800156606920



4G Module
for LED Multimedia Players



4G module can be used for all Optonica multimedia players. The 4G module, combined with external Sim card, enables you to access you're Optonica multi media player even when there is no Wi-Fi or LAN network available by using the 4G network. The compact module is plug and play, no further drivers are required.

- 4G module
- Access media player anywhere anytime
- Antenna included



SKU: 949 3800156609495



Power Supplies
Metal 5V output



Watts	200W	300W
Input Voltage	220V	220V
Output Voltage	DC:5V	DC:5V
Current	40A	60A
Material	Metal	Metal
Dimension	190x80x30mm	190x80x30mm

SKU: 6191 200W 3800156661912
 SKU: 6192 300W 3800156661929



Accessories



Light Sensor
for Brightness Adjustment



Accessory light probe with the following features:

- Monitor the brightness of the environment to achieve automatic adjustment of screen brightness.
- Connect the sending card and sending box, asynchronous card or multi-function card.
- Marking the 5 meter line, can be extended to 100 meters;
- In the outdoor use, three defense;
- No external power supply is required.

SKU: 951 3800156609518



18*10W Flat aluminium RGBW LED PAR Light



Voltage: AC90-260V 50/60Hz
 Power: 180W
 Light source: 18*10W RGBW led par light
 LED life: 50,000 hours.
 Lens degree: 15° 25°, 45° (optional)
 DMX channel :4/8CH
 Control Mode: Auto, Sound, DMX512, Master-slave
 Strobe: 0 ~ 20 times / sec.

SKU: 683 3800156606838

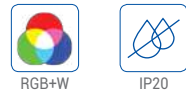

7*10w Mini RGBW LED PAR Light



Voltage: AC100~240V 50~60Hz
 Power consumption: 70W
 Light source: 7*10W RGBW 4in1 LED
 Beam angle: 15° 25° 40° optional
 DMX channels: 7 CHS
 Function: DMX AutoSound Master-slave, strobe, dimmer
 Housing Material : plastic
 Working Environment: -20~40
 Packing size: 22.5*10*22.5Cm (1pc/CTN)

SKU: 691 3800156606913

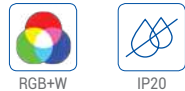

18*10W Flat aluminium RGB LED PAR Light



Voltage: AC90-260V 50/60Hz
 Power:180W
 Light source: 18x 10W 4 in 1 LED
 LED life: 50,000 hours.
 Lens degree: 15° 25°, 45° (optional)
 DMX channel :4/8CH
 Control Mode: Auto, Sound, DMX512, Master-slave
 Strobe: 0 ~ 20 times / sec.

SKU: 943 3800156609433



7*10w Remote Mini RGB+WW LED PAR Light



Voltage: AC100~240V 50~60Hz
 Power consumption 70W
 Light source: 7*10W RGB+WW 4in1 LED
 Beam angle: 25° optional
 DMX channels: 4/6CH
 Function: DMX, Remote, Auto, Sound, Master-slave, Strobe, Dimmer
 Housing Material : Plastic
 Protection power :IEC power in and out Working Environment: -20~40
 Packing size: 22.5*10*22.5Cm (1pc/CTN)

SKU: 692 3800156606920

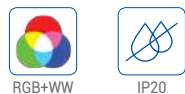

36*3W LED PAR Light



Voltage: AC100-260V 50Hz/60Hz
 Consumption: 50W/120W
 Lamp: 3W*36* LED lampR12G12B12
 Channel: 7CH
 Mode of control: DMX512, automatic, voice active.
 Function: Can make magic, color mixed, charming effect
 Packing size: 290*290*410mm

SKU: 690 3800156606906



NEW



Laser RGB5000

Voltage: AC90-240V, 50/60HZ
 Consumption: 120W
 Scanner: 25kkps
 Laser power:
 1x1000mW Red 638nm,
 1x1000mW Green 520nm,
 1X3000mW Blue 450nm
 Colors: RGB full color
 Control signal: DMX-512
 Control mode: music, auto, master-slave and DMX-512, ILDA control
 DMX channel: 10/34ch
 Size: 270x200x160 mm
 Weight: 5.5 kg



IP20

SKU: 166 3800156601666

NEW



3pcs *60W warm white + 36 *3W RGB

Input voltage: 100-240Vac/50-60Hz
 Product power: 250W
 Light source: 3pcs *60W warm white + 36 *3W RGB
 Channel: 14CH/22CH
 Control mode: DMX512, master/slave,
 self-propelled, voice control
 Dimming method: 0-100% ultra-smooth dimming
 Strobe: 25 times/sec



RGB



IP20

SKU: 128 3800156601284

NEW



Laser RGB3000

Voltage: AC90-240V, 50/60HZ
 Consumption: 120W
 Scanner: 25kkps
 Laser power:
 1x500mW Red 638nm,
 1x800mW Green 520nm,
 1X1700mW Blue 450nm
 Colors: RGB full color
 Control signal: DMX-512
 Control mode: music, auto, master-slave and DMX-512, ILDA control
 DMX channel: 10/34ch
 Size: 270x200x160 mm
 Weight: 5.5 kg



IP20

SKU: 165 3800156601659

NEW



WATERPFOOR RGBW 4in1 Flat Par 18

Voltage: AC100-240V
 Frequency: 50Hz-60Hz
 Consumption: 180W
 Lamp: 18pcs10W RGBW 4in1 LED
 Channel: 8/4CH
 IP rate: IP65
 Mode of control: DMX512, Auto, Sound, Master-slave.
 Function: Can make magic, color mixed, charming effect
 Net weight: 3.7KG



RGB+W



IP20

SKU: 129 3800156601291

NEW



Laser RGB1000

Voltage: AC90-240V, 50/60HZ
 Consumption: 120W
 Scanner: 20kkps
 Laser power:
 1x170mW Red 638nm,
 1x100mW Green 520nm,
 1X700mW Blue 445nm,
 Colors: RGB full color
 Control signal: DMX-512
 Control mode: music, auto, master-slave and DMX-512, ILDA control
 DMX channel: 10/34ch
 Size: 270x200x160 mm
 Weight: 5.5 kg



IP20

SKU: 164 3800156601642

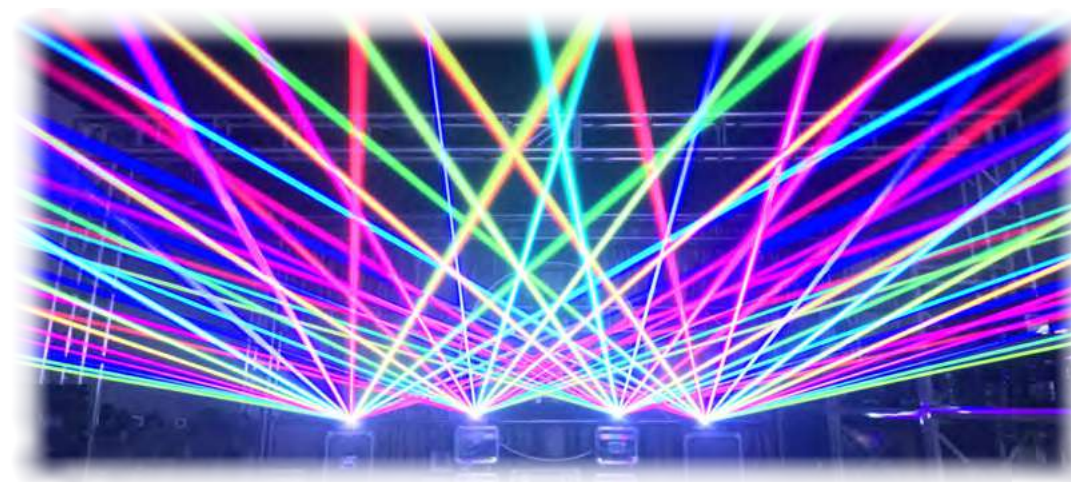



Battery

7x12W Waterproof RGB 6IN1 LED PAR Light Battery - Wireless

Waterproof 7x12W RGB 6IN1 Battery Wireless Led Par
 Light source: 7pcs 15w LED 4in1 mixing color
 Beam Angle: 25°
 Dimmer: 0-100% dimmer
 Strobe rate:0-24HZ
 Working Environment: -20-40
 DMX Channels: 2 DMX modes, 4channels mode & 8 channels mode
 Control Mode: DMX512,Master-slave,Sound,Auto,Wireless,remote.
 Battery type: Lithium Ion
 Battery Charge Time: 3hours(full power)
 Battery Life: 3.5(all on) hours,14 (single Color) hours
 Battery Power: 24V, 5Ah
 Wireless effective distance: 400meters

SKU: 940 3800156609402



RGB



IP54



7x8W Waterproof RGB 6IN1 LED PAR Light Battery - Wireless

Light source: 7pcs 8w LED 4in1 mixing color
 Beam Angle: 25°
 Dimmer: 0-100% dimmer
 Strobe rate:0-24HZ
 Working Environment: -20-40
 DMX Channels: 2 DMX modes, 4channels mode & 8 channels mode
 Control Mode: DMX512,Master-slave,Sound,Auto,Wireless,remote.
 Battery type: Lithium Ion
 Battery Charge Time: 3hours(full power)
 Battery Life: 3.5(all on) hours,14 (single Color) hours
 Battery Power: 24V, 5Ah
 Wireless effective distance: 400meters

SKU: 941 3800156609419



RGB



IP54



Battery

9*10W Wifi control Waterproof RGBA+UV 6 in 1

Power Supply: AC 100-240V/50-60Hz
 Power consumption: 90W
 Light source: 9pcs LED RGBWA+UV 6in1 mixing color
 Beam Angel: 15°
 Dimmer: 0-100% dimmer
 Strobe rate:0-24HZ
 Working Environment: -20-40
 DMX Channels: 2 DMX modes, 6channels mode & 10 channels mode
 Control Mode: DMX512,Master-slave,Sound,Auto,Wireless,remote, wifi
 Battery type: Lithium Ion
 Battery Charge Time: 6 hours
 Battery Life: (all on) 4 hours, (single Color) 24hours
 Battery Power: 12V, 25Ah

SKU: 932 3800156609327



RGBA+UV



IP54



Battery

12x10W Waterproof RGBWA+UV 6IN1 LED PAR Light

Voltage: AC100-240V 50Hz-60Hz
 Consumption: 150W
 LED: 12pcs 10W RGBWA+UV 6 in1 LED
 Channel: 6CH/9CH
 Mode of control: DMX512, Auto, Master-slave
 Function: Can make magic, color mixed, charming effect

SKU: 945 3800156609457



RGB-WA



IP65



Battery

24X3W RGB 3IN1 LED Wall Washer Battery - Wireless

Power Supply: AC 100-240V/50-60Hz
 Power consumption:80W
 Light source: 24pcs*3w LED RGB 3in1 mixing color
 Beam Angle: 10/20/25 degree
 Dimmer: 0-100% dimmer
 Strobe rate:0-24HZ
 Control Mode: DMX512,Master-slave,Sound,Auto, remote
 Build-in more than 9 build-in programs
 Generate endless effects with built-in, automated programs
 Product size: 1030x62x58mm

SKU: 936 3800156609365



RGB+W



IP20

NEW



Pixel control 18*10w RGBW 4in1 LED Wallwasher

Voltage: AC90V-245V/50-60Hz
 Power: 200W Light source
 Pixel control: 18*10w RGBW 4in1 LED wash
 Beam angle: 15° or 40° Rate :use indoor only
 Leds: 18pcs 10W RGBW 4IN1 LEDS
 Life time: >100 thousand hours
 Color: RGBW Wcolor can be mixed to more than 16.7million kinds of color
 Function effect: dimmer, strobe, eotic, gradual change



RGB-W



IP20

SKU: 993 3800156609938

NEW



Compact Pinspot LED 40W RGBW 4in1 Par with manual zoom

Power Supply: AC 100-240V/50-60Hz
 Power consumption: 40W
 Light source: 40 W RGBW 4in1 LED
 Beam Angle: 40°
 Zoom range: 4~60° manual zoom
 Dimmer: 0-100% dimmer
 Strobe rate: 0-20HZ
 Working Environment: -20-40
 IP rate: IP20, indoor
 DMX Channels: 6ch
 Control Mode: DMX512, Master-slave, Sound, Auto, Remote
 Net weight: 2kg



RGB-W



IP20

SKU: 990 3800156609907

NEW



5 Head Matrix Blinder

Voltage: AC100-240V 50/60Hz
 Power: 60W
 Light source: 5PCS 10W CREE RGB 3in1 LED
 Function: Color mix, automatic color change, built-in program and strobe effect with adjustable speed, dimmer, master/slave
 Light size: 620*130*160mm
 Weight: 4kg



RGB



IP20

SKU: 992 3800156609921

NEW



1000W LED Strobe RGB

Voltage: AC110-240V, 50/60HZ
 Consumption: 1000W
 Light source: 800pcs 1.2w SMD RGB LEDs
 Channel: 1CH /3CH/6CH
 IP rate: IP20
 Display Panel: LED Blue Display
 Housing material: Black Aluminum shell
 Mode of control: DMX512, Master-slave, Sound, Auto
 Dimension: 510*220*305mm
 Weight: 5.7kgs



RGB



IP20

SKU: 995 3800156609952

NEW



LED COB Blinder 2X100 W

LED: 2pcs*100W COB LED
 Light Color: Single color WW(100W)
 LED light time: over 50000 hours
 Voltage: AC 100V-240V 50-60Hz
 Power consumption: 260W
 Beam angle: 30 degree
 Dimmer: 0-100% linear adjustable
 Strobe: Variable speed (1-30Hz)
 Refresh rate: 11700Hz, 100% flicker free for film and TV camera
 Color effect feature: with individual control effect
 Power input: powercorn connector
 Housing material: Metal
 Control mode: DMX512, Master/Slave, Auto, Sound alone, Sound active
 DMX Channel: 2/5 CH



IP20

SKU: 994 3800156609945

NEW



Battery Mini 4 *10W RGBWA+UV 6in1 LED PAR

Power Supply: AC 100-240V/50-60Hz
 Power consumption: 40W
 Light source: 4pcs 10W LED RGBWA+UV 6in1 mixing color
 Beam Angle: 15°
 Dimmer: 0-100% dimmer
 Strobe rate: 0-24HZ
 Working Environment: -20-40
 IP rate: IP20, indoor
 DMX Channels: 6CH, 10CH
 Control Mode: DMX512, Master-slave, Sound, Auto, Remote



RGBWA+UV



IP20

SKU: 988 3800156609884

4x10W Wifi Control RGB 6IN1 Charging F Case



Battery

Power Supply: AC 100-240V/50-60Hz
 Power consumption: 40W
 Light source: 4pcs LED RGBWA+UV 6in1 mixing color
 Beam Angle: 15°
 Dimmer: 0-100% dimmer
 Strobe rate: 0-24HZ
 DMX Channels: 2 DMX modes, 6channels mode & 10 channels mode
 Control Mode: DMX512, Master-slave, Sound, Auto, Wireless, Wifi, Remote
 Battery type: Lithium Ion
 Battery Charge Time: 3 hours (full power)
 Battery Life: (all on) 6hours, (single Color) 36hours
 Battery Power: 12V, 10Ah
 Wireless effective distance: 400meters
 Product size: 140*140*200mm



RGB+WA



IP20

SKU: 935 3800156609358

Beam Moving Head Double Prism



Voltage: 100-240V 50/60Hz
 Power: 230W
 Channel: 16ch
 Light source: 230W Lamp
 Gobo wheel: 17 metal gobos+white
 Color wheel: 14 colors+white
 8/16prism/24prism optional, prism rotation
 Lens: 6-layer optic glass lens
 Motor: 2-phase step motors
 Features: moving more smoothly and no shake
 The channel list is same with Clay Paky
 Display: Roller Button screen
 Size: 410x460x510mm



IP20

SKU: 685 3800156606852

9X10W RGB 6IN1 LED PAR Light Charging F Case - Wireless Transmitter



Battery

Power consumption: 90W
 Light source: 9pcs LED RGBWA+UV 6in1 mixing color
 Beam Angle: 15°
 Dimmer: 0-100% dimmer
 Strobe rate: 0-24HZ
 DMX Channels: 2 DMX modes, 6channels mode & 10 channels mode
 Control Mode: DMX512, Master-slave, Sound, Auto, Wireless.
 Battery type: Lithium Ion
 Battery Charge Time: 6 hours
 Battery Life: (all on) 4 hours, (single Color) 24hours
 Battery Power: 12V, 25Ah
 Wireless effective distance: 400meters



RGB+WA



IP20

SKU: 937 3800156609372

Compact Mini Beam 7R Moving Head Light



Voltage: 100-240V 50/60Hz
 Power: 250W
 Channel: 16ch
 Light source: 230W Lamp
 Gobo wheel: 14 metal gobos+white
 Color wheel: 13 colors+white
 8facet prism, prism rotation
 Lens: 6-layer optic glass lens
 Motor: 2-phase step motors
 Features: moving more smoothly and no shake
 The channel list is same with Clay Paky
 Size: 310x220x440mm



IP20

SKU: 686 3800156606869

6X10 RGB 6in1 Battery LED PAR Light



Battery

Power consumption: 60W
 Light source: 6pcs LED RGBWA+UV 6in1 mixing color
 Beam Angle: 30°
 Dimmer: 0-100% dimmer
 Strobe rate: 0-24HZ
 DMX Channels: 2 DMX modes, 6channels mode & 10 channels mode
 Control Mode: DMX512, Master-slave, Sound, Auto, Wireless.
 Battery type: Lithium Ion
 Battery Charge Time: 4 hours
 Battery Life: (all on) 3.5hours, (single LED) 21hours
 Battery Power: 12V, 15Ah
 Wireless effective distance: 400meters



RGB+WA



IP20

SKU: 938 3800156609389

Beam Moving Head 330 15R



Power Supply: AC110v-240V 50/60hz
 Power: 350w
 Light source: 15R 330w lamp
 Ballast: electronic ballast
 Lens: 6-Layer option glass lens
 Beam angle parallel beam angle : 0-3.8°
 Channel: 16ch
 Color temperature: 8000K
 Prism: prism 1: Floral prism rotation, prism 2: 8 Prism rotation
 Gobo: 13 gobos+blank double rotation rainbow effect
 Colors 13 color+blank, single rotation rainbow effect
 Focus: option focus
 Mode of control: DMX512/Master-slave/Stand-alone /Auto mode
 Pan: 540degree (16bit) Electric correction
 Tilt: 270degree (16bit) Electric correction



IP20

SKU: 687 3800156606876



Remote control LED 30W spot moving head

Voltage: AC100-240V, 50/60HZ 60W
 Light Source: 1pc*30W White Lamp Bead
 Laser: Green 80mW
 Control Channel: 9/11CH
 Control Mode: Auto,DMX512,Master-slave,Sound
 Pan/Tilt: 540 degrees / 270 degrees

SKU: 123 3800156601239



300W LED Moving Head

LED source: 300W LED ; 8000K white LED,16*10W RGBW
 Working Time (hours): 50000
 Fixed gobo wheel: 8 fixed gobos + open and bi-direction rotation
 Color Temperature(CCT): 6000K (Daylight Alert)
 Pan X: 540 degree, Tilt Y: 270 degree
 Channel: 25ch/18ch Dimmer from 0-100%, Strobe
 Beam angle: 3 degree 1 rotate gobo wheel (7 gobos + open) and 1 fixed gobo wheel (8 gobos + open)
 1 Color wheel: 7 main colors + open with rainbow effect 2 Prism disk, Rotation prism,
 Focus Temperature protect function powercon in & out, color screen,
 Silent fan, good housing Pan/Tilt 0-255 speed controllable

SKU: 126 3800156601260



260 9R Beam Moving Head

Voltage: AC90-260V 50/60hz Power: 450W
 Source: YODN MSD 260W 9R,
 Average Lamp Life: 2000H Lumen Output: 10400LM
 Color Wheel: 14 color + white, halftone effect adjustment
 Gobo Wheel: 11 patterns + white
 Prisms: 8prism + Honeycomb prism (2 prisms can be superimposed to 40, can be two-way independent rotation)
 Pan: 540°(16bit accuracy) Tilt: 270°(16bit accuracy)
 Motors: 14 super mute motors, XY three-phase motor
 Frost/Atomization: independent frost effect, spot soft and natural
 Channel: 16/20CHs
 Size: 320*220*580mm (LWH)
 Net Weight: 14.8kg

SKU: 124 3800156601246



60W LED Spot Moving Head Light

Voltage: 100-240V 50/60Hz
 Power consumption: 80 W
 Color: 8 colors
 Gobo: 8 gobos
 Channel: 9/11ch
 Light source: 1PCS 60W high power White LED
 Control: DMX, Sound, Master-slave, Auto
 Size: 198*144*272 mm
 Net weight: 3.2 kg

SKU: 689 3800156606890



150W LED Beam Spot Wash 3in1 Moving Head

Voltage: AC100-240V,50/60Hz Power: 280W
 Led source: 150W White LED
 Led Life Time: 50000 Hours
 Channel: 18 DMX channel
 Pan: 540 degree + fine ; Tilt: 270 degree + fine
 Zoom range: 8-17°
 Strobe: 1-25 Hz with pulse effect
 Color Wheel: 9 colors + open, with rainbow effect
 Static Gobo Wheel: 10 gobos
 Rotation gobo wheel: 6 gobos+open
 Prism: 3 facet prism with bi-direction rotating
 Frost: With frost effect
 Display: LCD display, can adjust 180 degree to fit
 Product size: 275*200*475mm
 Net Weight: 9kg

SKU: 125 3800156601253



NEW



250W LED BSW Moving Head Light

Input Voltage: AC90-260V 50/60Hz
 Power Consumption: 350W
 Light Source: 250W High Output White LED
 Control Signal: DMX 512, master-slave and sound activated or auto operation
 Control Channel: 16/18 DMX Channels USITT DMX-512
 Prism: 8-facet Prism, bi-directional rotatable at variable speeds
 Dimensions: 320*220*480mm
 Weight: 13.50kg



Light



IP20

SKU: 981 3800156609815



NEW



80W LED Zoom Beam Moving Head

Input voltage: 110-260 V, 50/60 Hz Power: 150W
 Light source: 80W LED
 Working lifetime: About 50000 hours
 Control mode: DMX 512, Auto, Master-slave, Sound
 Channel: 16ch /20ch
 2DMX Modes: STD (16ch)/EXT (20ch)
 Prism: 8 linear prism rotating ,16 linear prism rotating
 Color Wheel: 13 colors+white
 Gobo Wheel: 11 gobos+white,gobo-flow effect,gobo shake
 Function: Dyeing, strobe, zoom, light beam effect
 Pan: 540° (16bit) Tilt: 270° (16bit)
 DMX socket: 3-pin IN/OUT
 Power socket: Power Con IN
 Dimensions: 460*250*290mm



Light



IP20

SKU: 982 3800156609822

NEW



10W LED Moving Head Spot

Input power: AC100-240V 50/60Hz
 Power consumption: 22W
 Output LUX: 1500 LUX at 3 meters
 LED: 1 PCS 10W high power white Cree LED
 DMX Channel: 9/11 channels
 Pan:X axis 540 degree ; Tilt:Y axis 270 degree
 Control mode: DMX512/Master-slave/Auto/Sound
 Display: LCD display
 Color wheel: 7 color+open
 Gobo Wheel: 7 gobo+open, gobo-flow effect,gobo shake
 Feature: 8 internal program, sound mode can control by DMX512
 Beam angle: 13 degree
 Net weight: 2.5kg
 Size: 140*160*290 cm



Light



IP20

SKU: 984 3800156609846

NEW



36*18W RGBWA+UV LED Moving Head+Zoom Light

Input Voltage: AC90-260V 50/60Hz
 LED: 36 *18W 6in1 RGBWA+UV LED moving
 Power Consumption: 650W
 Control Channel: 18/15 DMX channels
 Control Signal: DMX512, master-slave and sound activated or auto operation
 Power connection: Powercon In DMX data In/
 Out: XLR 3pin(XLR 5pin is optional)
 Packing Dimensions: 450*320*430mm
 Weight: 9 kg



Light



IP20

SKU: 983 3800156609839

NEW



6pcs LED Moving Head

Voltage: AC100V~240V/50~60Hz
 Machine power: 120W
 Lamp beads: 15W, RGBW four-in-one LED lamp beads
 Lamp life: more than 50,000 hours
 Lens: Lens Aspheric lens Supports DMX signal priority recognition, signal retention when DMX signal is interrupted
 Beam angle: 1.5°
 Spot angle: minimum 6°, maximum 51°
 Color Rotation System: Color Rotation System: RGBW 4-in-1 Rotation, Macro Function Color System
 Strobe: 1-30 times / sec electronic strobe and random strobe
 Scanning system: horizontal 540° / 1.5 seconds, vertical 180° / 0.5 seconds



Light



IP20

SKU: 986 3800156609860



200W LED Spot Moving Head

Input Voltage: AC100-240V 50/60Hz
 Power: 200W
 Light Source: 1 LED (white) 200 W,
 Beam Angle: 16°
 Colors: 7 + white, split colors, continuous scroll at variable speeds
 Rotation wheel (1): 6 + open (5 aluminum + 1 glass), rotating, interchangeable, slot-n-lock, continuous scroll at variable speeds
 Static wheel (2): 8 + open (8 stamped), continuous scroll at variable speeds
 Prism: 3-facet round, bidirectional rotation at variable speeds
 Strobe Rate: 0 to 15 Hz
 DMX Channels: 10 or 16
 Control mode : DMX 512, master-slave , sound , Auto
 DMX connector : 3-pin XLR connectors IN/OUT
 Dimension: 290x194x432mm



Light



IP20

SKU: 681 3800156606814

NEW



90W LED Spot Moving Head Light

Voltage: 100-240V 50/60Hz
 Power: 120v 60Hz 148W(0.1A)max,2A inrush
 Beam angle: 14degrees
 Channel: 14ch
 Light source: 1PCS 90W high power White LEDs
 Life rated: more than 50,000hrs
 Size: 250*255*360mm
 Net weight: 6kg
 Carton size: 370*360*340mm



Light



IP20

SKU: 985 3800156609853



120W LED Spot Pattern Moving Head

Input Voltage: AC100-240V 50/60Hz
 Power: 120W
 Light Source: 1 LED (white) 120 W,
 Beam Angle: 16°
 Colors: 7 + white, split colors, continuous scroll at variable speeds
 Rotation wheel (1): 6 + open (5 aluminum + 1 glass), rotating, interchangeable, slot-n-lock, continuous scroll at variable speeds
 Static wheel (2): 8 + open (8 stamped), continuous scroll at variable speeds
 Prism: 3-facet round, bidirectional rotation at variable speeds
 Strobe Rate: 0 to 15 Hz
 Control mode : DMX 512, master-slave , sound , Auto
 Cooling : Efficient low noise fan cooling system
 DMX connector : 3-pin XLR connectors IN/OUT



Light



IP20

SKU: 684 3800156606845



7x40w LED Wash Moving Head RGBW Mixing Color

Input: 110-240 V, 50/60 Hz
 Power: 320W
 Light source: 7* 40W RGBW 4in1 mixing color LED wash moving head
 Control mode:DMX512,Auto,Master-slave,Sound
 Channel:17ch/12ch
 2DMX Modes:STD(17ch)/HSI(12ch)
 Function:the dyeing effect,stroke,zoom, the beam light effect
 Pan:540°(16bit)Electric correction
 Tilt:270°(16bit)Electric correction
 Zoom range:9°~ 50°
 Dimmer:0-100% dimmer
 Size:240x300x405mm



RGBW



IP20

SKU: 682 3800156606821



12x10w LED Moving Head RGBW

Voltage: AC 110-240V 50/60 Hz
 Power: 150W
 LED QTY: 12*10W RGBW 4in1 LED Moving Head Light
 Lumens: 4500+, Lux @2m 40500+
 Control: Master-Slave / Auto / Sound / DMX
 Channel control: 15CH
 Dimmer: 0-100%
 Flash: 0-20Hz
 Pan / Tilt: User -selectable Pan / Tilt ranges
 Pan/ Tilt: 540 degrees / 270 degrees
 Fine Turning: 8-16 bit
 Color: Black / White
 Size: 300x245x385mm



RGBW



IP20

SKU: 688 3800156606883



19x15W AURA LED Beam Moving Head Light Zoom RGBW

Input Voltage: AC90-260V 50/60Hz
 Power Consumption: 300W
 Zoom range:8-28degree. Motor:3pcs
 Control mode:DMX512, master-slave, Sound, Auto
 Channel: 14/25CHs
 Beam(Primary LED array): provide the main output
 Aura(Secondary background LED array): illuminate the front of the head, provide local diffuse light output and can be set to contrast with the beam output.
 Beam: RGBW color control with color temperature control
 Aura: RGB control ; Dimming: 0-100% smoothly dimmer
 Strobe: 20t/s strobe effect with variable speed and pulse effects
 540° PAN and 270° TILT movement
 Size: 410x320x470mm

SKU: 693 3800156606937



4x12W LED Moving Head Light RGBW

Voltage: AC 100*240v 50/60 hz
 Power Consumption: 60w
 Lighting Source: 4*12w RGB+W
 RGBW color mixing
 DMX Channels: Two DMX channels model , 11 or 18
 Control Mode: Auto, Sound Active, Master/Slave, DMX 512
 Dimming: 0-100%
 Strobe: slow to fast
 Pan: 540 degrees, Tilt: 180 deagrees
 Size: 300x20x240mm

SKU: 933 3800156609334



Power CON IN



SKU: 679 3800156606784 SKU: 960 3800156609600

XLR 3PIN -Male , Female - LH P005A



SKU: 678 3800156606784 SKU: 963 3800156609631

Power CON OUT



SKU: 961 3800156609617 SKU: 962 3800156609624

Hook



SKU: 698 30mm 3800156606982
 SKU: 699 50mm 3800156606999

Safety Rope



SKU: 697 3800156606975



Spark Firework Machine

Voltage: AC 110-240V 50/60 HZ
 Power: 400W
 Control: DMX, remote control
 Temperature: (-10/+50°C)
 Height: 1-5 m
 Spray direction: erect
 DMX Channel: 2
 NW: 9.5 kg

SKU: 902 3800156609020



Stage Fog Waterproof Spark Machine

Power: 400W
 Control: DMX, Remote control
 Temperature (-10/+50°C)
 Height: 1-4 meter
 Spray direction:fall
 DMX Channel: 2
 Machine Size: 200x200x180mm
 NW: 6.5KG

SKU: 903 3800156609037



LPG Fire Machine

Voltage: AC110-240V 50/60HZ
 Power: 250W
 Spary Height: 1-2 meter
 Control: DMX512/Electric Control/remote control
 DMX Channel: 1
 Gas: LPG fire gas bottle
 Machine Size: 420x165x200mm
 NW: 7KG

SKU: 904 3800156609044



Firebolt Fire Machine

Voltage: AC110-240V 50/60HZ
 Power: 250W
 Spary Height: 1-4 meter
 Control: DMX512/remote control
 DMX Channel: 4
 Gas: LPG Gas bottle
 Machine Size: 50x35x27CM
 NW:13KG

SKU: 905 3800156609051



Fog Machine Hand-held CO2 Gun



DJ CO2 Gun only needs a container with CO2. Easy to operate. This product is recommended for DJs, discos, bars and parties.

JET DIST: 6 m
NW: 3.2 kg

SKU: 901 3800156609013



LED Fog Machine 900W



Voltage: AC110-240V 50/60HZ
Power: 920W
Control: remote control
Re-heating time: 3 mins
LED: 3WX6pcs
Capacity of oil tanks 1.5L
Size:385x230x140mm
NW 4KG

SKU: 911 3800156609112



Water Low Fog Machine



Voltage: AC110-240V 50/60HZ
Power: 3000W
Cover area:150-200 square meter
Control:DMX512/remote control/manual
DMX Channel: 2
Consumable materials: water+heavy fog liquid
Capacity of fog tank: 3L
Capacity of water tank: 15L
Machine Size: 714x400x316mm
GW: 52KG

SKU: 908 3800156609082



Fog Machine 1000W



Voltage: AC110 - 240V 50/60HZ
Power: 1000W
Control: remote control/wire control
Re-heating time: 5 mins
Capacity of oil tanks 1 L
Size: 360x200x130mm
NW: 4KG

SKU: 912 3800156609129



Dry Ice Machine 3000W



Voltage: AC110-240V 50/60HZ
Power: 3000W
Cover area: 100-200 square meter
Control: Manual
Consumable materials: Dry ice and water
Machine Size: 660x 370x580mm
NW: 16KG

SKU: 909 3800156609099



Fog Machine 1500W



Voltage AC110 240V 50/60HZ
Power: 1500W
Control:remote contro/DMX 512
Re-heating time: 5 mins
Capacity of oil tanks 3 L
Size 510x260x150mm
NW: 6KG

SKU: 913 3800156609136



Fog Machine 900W



Voltage AC220V-240V 50/60HZ
Power: 900W
Control:remote control/wire control
Re-heating time 5 mins
Capacity of oil tanks 1.5L
Body color: black with hanging bracket
Machine Size:36.5x18.5x17cm
NW 3KG

SKU: 910 3800156609105



LED Fog Machine 1500W



Voltage: AC110-240V 50/60HZ
Power: 1520W
Control: remote contro/wire control/ time
Re-heating time: 5 mins
Capacity of oil tanks: 2.5 L
Machine Size: 540x330x260mm
NW: 6KG

SKU: 914 3800156609143





NEW



LED RGB CO2 Machine

LEDs: 12x3w RGB 3 in 1
 Voltage: AC220/110V 50/60HZ
 Power: 250W
 Control: DMX512, remote control
 DMX channels: 9
 Column height: 8-10 m
 Machine Size: 310x310x430 mm
 Weight: 7.0KG

SKU: 664 3800156606647



NEW



DMX Power Splitter ST-4

3 pin XLR IN/OUT
 Power: 15W
 Output: 4 DMX
 Size: 430x50x180mm
 Net weight: 2.35kg

SKU: 694 3800156606944



NEW



DMX Power Splitter ST-8

3 pin XLR IN/OUT
 Power: 15W
 Output: 8 DMX
 Size: 430x50x180mm
 Net weight: 2.35kg

SKU: 695 3800156606951





Fog Machine 3000W

Voltage: AC110-240V 50/60HZ
 Power: 3000W
 Control: DMX512/remote control
 Re-heating time: 5 mins
 Capacity of oil tanks: 5L
 Size: 68x31x20CM
 NW: 13KG

SKU: 915 3800156609150



FOG



Portable Haze Machine

Voltage: AC110~240V 50/60HZ
 Power: 1500W
 Re-heating time: 45 sec
 Control: DMX512/ Remote control/Manual
 Use consumables: Water based haze liquid
 Capacity of oil tank: 2L
 Size: 325x153x340mm
 NW: 8KG

SKU: 916 3800156609167



HAZE



Hanging Type Haze Machine

Voltage: AC110~240V 50/60HZ
 Power: 1000W
 Warm-up time: 30 sec
 Control: DMX512/ Remote control/Manual
 Use consumables: Water based haze liquid
 Capacity of oil tank: 2L
 Weight: 9kg
 Size: 440x340x340mm

SKU: 917 3800156609174



HAZE



Oil Based Haze Machine

Voltage: AC110-240V 50/60HZ
 Power: 650W
 Re-heating time: 0 second
 Capacity of oil tank: 2.5L
 Control: DMX-512, remote control, Manual
 Machine size: 590x450x450mm
 NW: 23KG

SKU: 918 3800156609181



HAZE



Hand Confetti Machine



Voltage: AC110~240V 50/60HZ
 Confetti capacity: 0.5kg
 Control: Manual
 Use consumables: Bullion paper/Color paper
 Gas: Co2/N2
 Weight: 7kg
 Size: 970x300x210mm

SKU: 906 3800156609068



Confetti

LED Electric Confetti Machine



Voltage: AC110-240V 50/60HZ
 Power: 1236W
 Control: DMX 512, remote control
 Height of ejection: 6-8M
 DMX Channel: 7
 Confetti capacity: 0.5KG
 Size: 280x280x550mm
 NW: 8KG

SKU: 907 3800156609075



Light



Confetti



Window cleaning
Robot

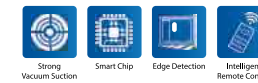

Product code OT01-C1
 Cleaning speed 2 minutes / m2
 Power 80W
 Size 300x150x120mm
 Cleaning Modes 3 modes

SKU: 757 3800156607576



Window cleaning
Robot

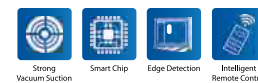

Product code OT01-C1
 Cleaning speed 2 minutes / m2
 Power 80W
 Size 250x250x9.5mm
 Cleaning Modes 3 modes
 UPS 20min

SKU: 758 3800156607583

OPTONICA COMFORT PRODUCTS



Air Purifier & Humidifier

Breathe Cleaner and Healthier Air

7 Stage Air Purification + Humidifier
UV Lamp and IONIZER + WIFI

Product code	OT01-C1
CADR(PM2.5)	450m3/h
Power	85W
Area	~50 m2
Size	400x230x620mm
Purification	Pre-filter, Cold-catalyst, Formaldehyde removal filter (Honeycomb activated carbon filter Optional), Antibacterial filter, UV Sterilization, HEPA filter, Anion release.

SKU: 733 3800156607330



Air Purifier

Breathe Cleaner and Healthier Air

6 Stage Air Purification
UV Lamp and IONIZER

Product code	OT01-C1
CADR(PM2.5)	150m3/h
Power	43W
Area	~30 m2
Size	330x180x505mm
Purification	Cold-catalyst, Formaldehyde removal filter (Honeycomb activated carbon filter Optional), Antibacterial filter, UV Sterilization, HEPA filter, Anion release

SKU: 731 3800156607316



Air Purifier & Humidifier

Breathe Cleaner and Healthier Air

6 Stage Air Purification + Humidifier
UV Lamp and IONIZER

Product code	OT01-C1
CADR(PM2.5)	300m3/h
Power	65W
Area	~38 m2
Size	360x195x565(mm)
Purification	Cold-catalyst, Formaldehyde removal filter (Honeycomb activated carbon filter Optional), Antibacterial filter, UV Sterilization, HEPA filter, Anion release.

SKU: 732 3800156607323



Air Purifier

Breathe Cleaner and Healthier Air

7 Stage Air Purification
UV Lamp and IONIZER

Product code	OT01-C1
CADR(PM2.5)	320m3/h
Power	80W
Area	~40 m2
Size	370x195x605mm
Purification	Pre-filter, Cold-catalyst, Formaldehyde removal filter (Honeycomb activated carbon filter Optional), Antibacterial filter, UV Sterilization, HEPA filter, Anion release.

SKU: 734 3800156607347



SMART CAMERA ROBOTIC VACUUM CLEANER

SKU: 752
3800156607521



BRUSHLESS VACUUM MOTOR+ROLLER BRUSH

Clean thoroughly

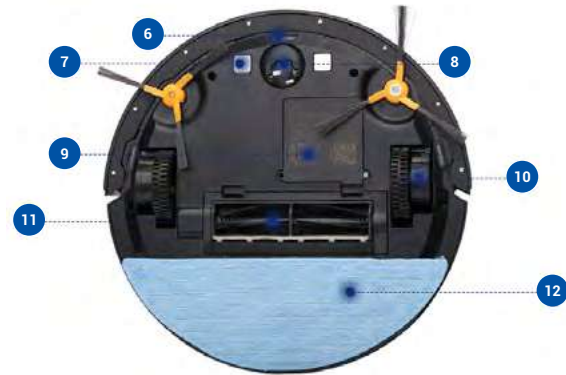

1 Side Brush	2 Power Button	3 Camera	4 Power Switch
5 Glass Cover	6 Anti-drop Sensor	7 Charging Connect	8 Universal Wheel
9 Battery Cover	10 Wheel	11 Roller Brush	12 Mop

Working Time Per Charge: 80-120mins

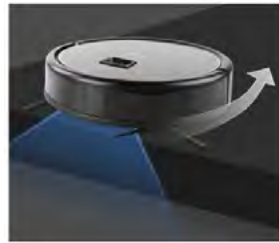

ANTI-DROP SENSORS

Keep machine safety away from stairs

ANTI-COLLISION SENSORS

Effective protect machine and furniture



EASY CLIMBING

Moves over thresholds

GO TO CLEAN UNDER THE FURNITURE

Without omission



AUTOMATIC CHARGING

Back to charging dock automatically when battery is low

BREAKPOINT RESUME OPERATION

After charging, machine returns to breakpoint, continue to clean the remaining area.



SMART GYRO ROBOTIC VACUUM CLEANER

SKU: 753
3800156607538



**GYROSCOPE NAVIGATION
MULTIPLE CLEANING MODES**



ROADROVER WHEELS

Climbing ability reach 2cm
With cross-country wheel,
Easy go crossing the obstacle

10 PAIRS OF INFRARED ANTI-COLLISION SENSORS



AUTOMATIC DOCK AND CHARGING

AUTO CLEANING ROBOTIC VACUUM CLEANER

SKU: 754
3800156607545



STRONG SUCTION
Up to 1000PA, no dust can hide from it



VARIOUS GROUND TYPE APPLICATION

Suitable for various floor type, low pile carpet, tile, wood floor, etc



3 in 1 Wireless Charging Station
Apple iPhone/AirPods/iWatch
Samsung Phone/Buds/Watch



- Wireless Charging
- IP20
- 3-in-1 Wireless Charging
- Compact Design
- Phone Stand

SKU: 9500 For iPhone 3800156695009
SKU: 9501 For Samsung 3800156695016

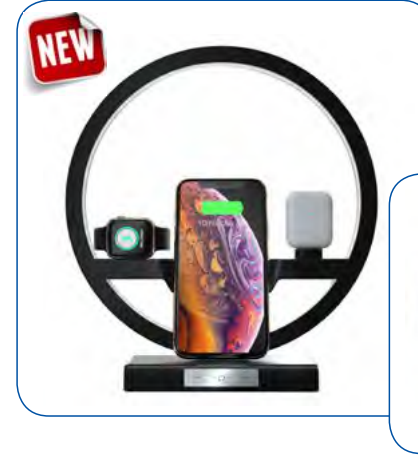

3 in 1 Multifunction Desk Lamp
Wireless Charging



- Wireless Charging
- IP20
- 3-in-1 Wireless Charging
- Phone Stand

SKU: 9512 Black Body 3800156695122
SKU: 9513 White Body 3800156695139



6 in 1 Multi-function Charging Station
Match multiple devices



- Wireless Charging
- IP20
- for phone
- for iWatch
- for AirPods

SKU: 9502 Black Body 3800156695023
SKU: 9503 White Body 3800156695030



3 USB Quick Charger
36W Max Power



- PD + 3USB
- IP20
- quick charge
- 3 USB ports
- PD 20W
- smart chip

SKU: 9510 Black Body 3800156695108
SKU: 9511 White Body 3800156695115



Wireless Charger Pad
Qi Standard



- Compact Design
- Wireless Charging
- IP20
- Universal input: 5.0V=2A Universal output: 5.0V 1A
- Fast charge input: 9.0V 2A Fast charge output: 9.0V 1.2A

SKU: 9508 Black Body 3800156695085
SKU: 9509 White Body 3800156695092



Car Wireless Charger Stand
36W Max Power

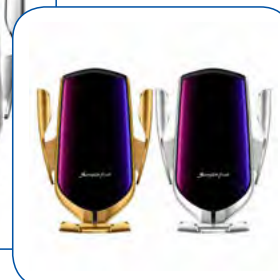

- Wireless Charging
- IP20
- 10W Wireless charging
- Inductive Stretching
- Steady
- Large area induction coil

SKU: 9506 Gold Body 3800156695108
SKU: 9507 Silver Body 3800156695115

Wireless Charging Clock
supports iOS and Android



- Wireless Charging
- IP20
- Clock
- Temperature
- USB
- Date
- 12H/24H
- Alarm Clock

SKU: 9514 Clock 3800156695146

Bluetooth FM Transmitter
Car Charger With MP3 Player



- Fast Charging
- Bluetooth Hands Free
- 2xUSB

SKU: 9504 FM Transmitter 3800156695047



3 in 1 Magnetic USB Cable
Type-C , Micro USB, For Apple

- 1M-Long

SKU: 9516 Charging Cable 3800156695160

CCT Selfie Ring Light
10W 5V USB - Dimmable



- 800 Lumens
- 120°
- IP20

Watts 10W
Input Voltage 5V USB
Flux 800lm
Beam Angle 120°
Dimmable YES

- 6000K
- 4000K
- 3000K

SKU: 9515 Selfie Ring Light 3800156695115

SKU	Page No.	SKU	Page No.	SKU	Page No.	SKU	Page No.	SKU	Page No.	SKU	Page No.
123	398	603	376	692	689	932	393	1265	33	1439	24
124	398	605	376	693	404	933	404	1266	33	1440	24
125	398	606	376	694	409	935	396	1267	33	1447	25
126	399	607	378	695	409	936	393	1268	33	1448	25
128	391	608	378	697	404	937	396	1269	33	1449	25
129	391	609	376	698	404	938	396	1270	33	1451	25
164	390	610	377	699	404	940	392	1271	33	1452	25
165	390	611	377	731	414	941	392	1272	33	1453	25
166	390	612	377	732	414	943	388	1273	33	1457	23
221	319	613	379	733	414	945	392	1274	33	1458	23
222	128	614	379	734	414	946	385	1305	7	1459	23
225	319	615	379	752	416	947	383	1306	7	1460	23
226	319	616	379	753	417	948	383	1308	8	1461	23
501	359	617	378	754	417	949	387	1309	8	1462	23
502	359	618	378	757	413	950	382	1310	9	1463	23
507	359	619	378	758	413	951	387	1311	9	1464	23
515	359	620	379	802	380	952	385	1312	9	1465	23
516	359	621	381	803	380	960	404	1313	10	1466	24
517	359	622	380	804	380	961	404	1314	10	1467	24
550	359	630	376	805	381	962	404	1315	10	1468	24
551	359	631	376	806	381	963	404	1316	10	1469	14
565	355	638	377	856	354	981	400	1317	10	1470	14
566	355	639	377	863	357	982	400	1318	10	1471	14
567	355	640	377	864	357	983	400	1319	10	1472	14
568	355	650	382	865	357	984	401	1320	10	1473	14
571	358	651	382	866	356	985	403	1321	10	1474	12
572	358	653	382	867	356	986	401	1322	7	1475	12
573	358	654	382	868	356	988	395	1323	9	1476	12
580	357	655	382	872	356	990	395	1324	9	1477	12
581	357	656	386	873	356	992	394	1325	11	1478	12
582	357	660	384	874	356	993	394	1326	11	1479	12
583	357	661	384	879	357	994	394	1330	18	1470	14
584	357	662	380	901	406	995	395	1331	18	1471	14
585	357	664	409	902	405	1066	28	1332	18	1472	14
586	354	665	380	903	405	1067	28	1333	19	1473	14
587	354	671	381	904	405	1068	28	1334	19	1474	12
588	354	673	381	905	405	1163	31	1335	19	1475	12
589	354	678	404	906	411	1164	31	1410	16	1476	12
590	354	679	404	907	411	1167	31	1411	16	1477	12
591	355	681	402	908	406	1168	31	1412	16	1478	12
592	357	682	403	909	406	1169	31	1413	14	1479	12
593	357	683	388	910	406	1170	31	1414	16	1480	15
594	355	684	402	911	407	1191	31	1415	15	1481	15
595	355	685	397	912	407	1192	31	1416	15	1482	15
596	356	686	397	913	407	1193	31	1417	13	1483	24
597	356	687	397	914	407	1194	31	1418	13	1484	24
598	356	688	403	915	410	1195	31	1419	23	1485	24
599	356	689	399	916	410	1196	31	1420	23	1487	24
601	376	690	389	917	410	1263	33	1421	23	1488	24
602	376	691	389	918	410	1264	33	1438	24	1489	24

SKU	Page No.	SKU	Page No.	SKU	Page No.	SKU	Page No.
1490	14	1711	17	1769	40	1858	8
1491	15	1718	36	1770	40	1859	8
1492	13	1719	36	1772	40	1860	12
1493	25	1720	36	1773	40	1861	12
1494	25	1721	36	1774	18	1862	12
1495	25	1722	36	1775	18	1863	12
1496	25	1723	36	1776	18	1864	10
1497	25	1724	37	1777	19	1865	10
1498	25	1725	37	1778	19	1866	10
1516	29	1726	37	1779	19	1867	11
1517	29	1727	36	1780	39	1868	11
1518	29	1728	36	1781	39	1869	11
1519	29	1729	36	1782	39	1872	13
1528	22	1730	37	1790	4	1876	21
1529	22	1731	37	1791	4	1877	21
1530	22	1732	37	1792	4	1878	21
1531	30	1733	37	1793	4	1879	6
1532	30	1734	37	1794	11	1880	6
1533	30	1735	37	1795	7	1881	20
1534	30	1736	38	1796	9	1882	20
1535	30	1738	38	1813	22	1883	20
1536	30	1739	38	1814	22	1884	21
1541	30	1740	38	1815	22	1885	21
1542	30	1741	38	1816	22	1886	21
1543	30	1742	38	1817	22	1887	5
1615	28	1743	38	1818	22	1888	5
1616	28	1744	38	1819	21	1889	5
1617	28	1745	38	1830	18	1890	5
1638	28	1746	38	1834	19	1893	6
1639	28	1747	38	1835	19	1896	6
1640	28	1748	37	1836	19	1899	8
1644	28	1749	37	1837	19	1910	26
1645	28	1750	37	1838	22	1914	26
1646	28	1751	39	1839	22	1915	27
1651	29	1752	39	1840	22	1916	27
1652	29	1753	39	1841	20	1917	27
1653	29	1754	39	1842	20	1918	26
1654	29	1755	39	1843	20	1919	26
1655	29	1756	39	1844	20	1920	26
1656	29	1757	39	1845	21	1921	26
1701	17	1758	39	1846	21	1922	26
1702	17	1759	39	1847	21	1923	26
1703	17	1761	40	1849	18	1929	34
1704	18	1762	40	1850	18	1930	34
1705	18	1763	40	1851	19	1931	34
1706	18	1764	40	1852	19	1932	34
1707	20	1765	40	1854	8	1933	34
1708	20	1766	40	1855	8	1934	34
1709	20	1767	40	1856	8	1935	34
1710	17	1768	40	1857	8	1936	34

SKU	Page No.	SKU	Page No.	SKU	Page No.	SKU	Page No.	SKU	Page No.	SKU	Page No.	SKU	Page No.	SKU	Page No.	SKU	Page No.
1937	34	2024	54	2083	46	2377	142	2441	156	2540	95	2675	148	2777	133		
1938	34	2025	55	2084	345	2382	133	2442	156	2541	95	2676	148	2780	140		
1939	34	2026	55	2085	324	2383	133	2443	156	2542	95	2677	148	2781	140		
1940	34	2027	52	2086	324	2384	133	2444	157	2581	158	2678	149	2782	140		
1943	35	2028	52	2087	324	2385	142	2445	157	2582	158	2679	149	2788	138		
1945	35	2029	52	2088	324	2386	142	2446	157	2583	158	2680	149	2789	138		
1946	35	2030	52	2089	325	2387	142	2447	157	2584	158	2681	149	2790	138		
1947	35	2031	48	2090	325	2391	137	2448	157	2585	158	2682	149	2791	139		
1950	27	2032	48	2091	325	2392	137	2449	157	2586	160	2683	149	2792	139		
1951	27	2033	48	2092	319	2393	137	2450	157	2587	160	2684	149	2793	139		
1952	27	2034	48	2093	327	2394	138	2451	157	2590	154	2685	149	2794	139		
1953	27	2035	49	2095	324	2395	138	2452	157	2591	154	2686	149	2795	139		
1954	27	2036	49	2096	324	2396	138	2453	157	2592	154	2687	149	2796	139		
1955	27	2037	49	2231	98	2397	138	2454	157	2593	154	2688	149	2797	139		
1956	27	2038	49	2232	98	2398	138	2455	157	2594	155	2689	149	2798	139		
1957	32	2039	50	2235	98	2399	138	2456	157	2595	155	2701	134	2799	139		
1958	32	2040	50	2236	98	2401	96	2470	152	2596	155	2702	134	2801	109		
1959	32	2041	50	2237	99	2402	96	2471	152	2597	155	2703	134	2802	109		
1960	32	2042	50	2238	99	2403	96	2472	152	2601	150	2704	134	2803	109		
1961	32	2043	50	2241	98	2404	96	2473	152	2602	150	2705	134	2804	109		
1962	32	2044	50	2242	98	2405	96	2474	152	2603	150	2706	134	2805	109		
1963	32	2045	55	2243	98	2406	96	2475	152	2604	150	2707	134	2806	109		
1964	32	2046	55	2244	98	2407	96	2476	152	2605	150	2708	134	2807	108		
1965	32	2047	45	2245	98	2408	96	2477	152	2606	150	2711	135	2808	108		
1970	35	2048	45	2246	98	2409	96	2478	152	2608	150	2712	135	2809	108		
1971	35	2049	45	2247	98	2410	96	2479	152	2609	150	2713	135	2810	108		
1972	35	2050	45	2248	98	2411	96	2480	152	2610	150	2714	142	2811	108		
2001	51	2051	45	2249	98	2412	96	2481	152	2611	150	2715	142	2812	108		
2002	51	2052	45	2250	98	2413	97	2482	152	2612	150	2716	142	2813	108		
2003	51	2054	57	2251	99	2414	97	2483	152	2613	150	2717	135	2814	108		
2004	51	2060	56	2252	99	2415	97	2484	152	2614	151	2718	135	2815	108		
2005	51	2061	56	2253	99	2416	97	2485	152	2615	151	2726	136	2816	108		
2006	51	2062	56	2254	99	2417	97	2486	153	2616	151	2727	136	2817	108		
2007	51	2063	56	2255	99	2418	97	2487	153	2617	151	2728	136	2818	108		
2008	51	2065	57	2256	99	2419	97	2488	153	2618	151	2734	136	2840	112		
2009	44	2066	57	2257	99	2420	97	2489	153	2619	151	2735	136	2841	112		
2010	44	2067	57	2258	99	2421	97	2490	153	2630	151	2736	136	2842	112		
2011	44	2068	58	2297	117	2422	97	2491	153	2631	151	2737	136	2843	112		
2012	44	2069	58	2335	156	2423	97	2492	153	2632	151	2738	136	2844	112		
2013	47	2070	58	2336	156	2424	97	2493	153	2642	151	2739	136	2845	112		
2014	47	2071	58	2348	157	2431	156	2494	153	2644	151	2740	132	2846	112		
2015	47	2072	59	2349	157	2432	156	2496	153	2666	148	2741	132	2847	112		
2016	47	2073	59	2350	133	2433	156	2497	153	2667	148	2744	135	2848	113		
2017	53	2074	59	2351	133	2434	156	2498	153	2668	148	2745	135	2849	113		
2018	53	2075	59	2363	133	2435	156	2499	153	2669	148	2746	140	2850	113		
2019	53	2080	46	2372	137	2436	156	2535	94	2670	148	2770	132	2851	113		
2020	53	2081	46	2373	137	2437	156	2536	94	2671	148	2771	132	2852	113		
2021	54	2082	46	2374	137	2438	156	2537	94	2672	148	2772	137	2853	113		
2022	54	2081	46	2375	142	2439	156	2538	94	2673	148	2773	137	2854	113		
2023	54	2082	46	2376	142	2440	156	2539	95	2674	148	2776	133	2855	113		

SKU	Page No.	SKU	Page No.	SKU	Page No.	SKU	Page No.
2856	113	2925	105	3286	164	4480	187
2857	113	2926	105	3287	165	4481	187
2858	114	2927	105	3288	165	4482	187
2859	114	2928	105	3289	165	4483	187
2860	115	2929	106	3290	164	4484	187
2861	115	2930	106	3291	164	4485	186
2870	110	2931	106	3292	164	4486	186
2871	110	3201	166	3293	165	4487	186
2872	110	3202	166	3294	165	4490	189
2873	110	3204	166	3295	165	4491	189
2874	110	3205	166	4311	179	4492	189
2875	110	3206	166	4312	179	4511	206
2876	110	3207	166	4313	175	4512	206
2877	110	3212	166	4314	175	4513	206
2878	110	3222	166	4315	179	4514	206
2879	111	3223	166	4316	190	4515	206
2880	111	3224	166	4321	190	4516	206
2881	111	3225	166	4322	190	4521	206
2882	111	3241	167	4323	190	4522	206
2883	111	3242	167	4324	192	4523	206
2884	111	3243	167	4325	192	4524	206
2885	111	3251	167	4326	192	4525	206
2886	111	3252	167	4327	192	4526	206
2887	111	3253	167	4328	191	4531	207
2888	116	3254	167	4329	191	4532	207
2889	116	3255	167	4330	191	4533	207
2901	102	3256	167	4403	188	4534	207
2902	102	3257	161	4404	188	4535	207
2903	103	3258	161	4405	188	4541	200
2904	103	3260	169	4406	188	4542	200
2905	102	3261	169	4421	183	4543	200
2906	102	3262	169	4422	183	4544	200
2907	103	3263	169	4423	183	4545	200
2908	103	3264	164	4424	185	4546	200
2909	102	3265	164	4425	185	4551	201
2910	102	3266	164	4426	185	4552	201
2911	103	3267	165	4431	183	4553	201
2912	103	3268	165	4432	183	4554	201
2913	104	3269	165	4433	183	4555	201
2914	104	3270	168	4441	184	4561	207
2915	104	3271	168	4451	183	4562	207
2916	104	3272	168	4452	183	4563	207
2917	104	3273	168	4453	183	4564	206
2918	104	3274	168	4454	185	4580	203
2919	104	3275	168	4455	185	4581	203
2920	104	3276	168	4456	185	4582	203
2921	105	3277	168	4461	184	4583	203
2922	105	3278	168	4462	184	4584	203
2923	105	3284	164	4463	184	4585	203
2924	105	3285	164	4471	184	4586	203

SKU	Page No.	SKU	Page No.	SKU	Page No.	SKU	Page No.	SKU	Page No.	SKU	Page No.	SKU	Page No.	SKU	Page No.	SKU	Page No.
4587	203	4852	181	5027	249	5096	361	5175	193	5335	265	5387	251	5465	269		
4588	203	4853	181	5028	249	5097	43	5180	107	5336	265	5388	251	5466	269		
4589	203	4854	181	5029	249	5098	43	5181	107	5337	265	5389	252	5467	269		
4590	202	4855	181	5030	249	5099	43	5182	145	5338	265	5390	252	5511	73		
4591	202	4856	181	5031	247	5101	194	5183	194	5339	265	5391	149	5512	73		
4592	202	4857	181	5032	247	5102	194	5184	193	5340	258	5392	149	5513	73		
4593	202	4858	181	5033	247	5103	194	5185	193	5341	258	5393	258	5514	73		
4594	202	4861	179	5034	247	5104	193	5188	145	5342	258	5394	260	5515	73		
4595	202	4862	179	5035	247	5105	193	5190	193	5343	260	5395	260	5516	73		
4596	202	4904	180	5036	249	5106	193	5191	193	5344	260	5396	260	5517	73		
4597	202	4905	180	5037	249	5107	194	5192	193	5345	260	5397	260	5518	73		
4598	202	4906	180	5038	249	5108	193	5193	193	5346	260	5398	259	5519	73		
4599	202	4911	180	5039	249	5109	194	5197	145	5347	259	5399	259	5541	72		
4611	204	4912	180	5040	249	5110	194	5198	145	5348	259	5400	259	5542	72		
4612	204	4913	180	5041	171	5111	195	5210	292	5349	259	5401	289	5543	72		
4700	174	4921	180	5042	171	5112	195	5212	292	5350	257	5402	289	5544	72		
4702	174	4922	180	5043	171	5113	193	5233	292	5351	257	5403	288	5545	72		
4703	174	4923	180	5044	170	5114	196	5277	293	5352	257	5404	288	5546	72		
4704	174	4941	182	5045	170	5115	196	5279	293	5353	257	5405	288	5547	72		
4706	174	4942	182	5046	170	5116	196	5301	294	5354	263	5411	257	5548	72		
4710	174	4943	182	5047	250	5117	196	5302	294	5355	263	5412	257	5549	72		
4711	174	4944	182	5051	360	5118	196	5303	286	5356	263	5413	257	5550	71		
4720	176	4945	182	5052	360	5119	196	5304	286	5357	263	5414	257	5551	71		
4731	176	4946	182	5053	360	5120	196	5305	286	5358	257	5415	257	5552	71		
4732	176	5001	195	5054	360	5121	196	5306	286	5360	257	5416	262	5553	71		
4733	176	5002	195	5055	360	5122	196	5307	294	5361	257	5417	262	5554	71		
4734	176	5003	159	5056	361	5123	196	5308	294	5362	257	5418	262	5555	71		
4735	176	5004	159	5057	361	5124	196	5311	262	5363	257	5419	262	5556	71		
4736	176	5005	159	5058	361	5125	196	5312	262	5364	257	5420	257	5557	71		
4740	174	5006	159	5070	42	5128	197	5313	262	5365	257	5421	257	5558	71		
4761	175	5007	255	5071	42	5130	197	5314	262	5366	257	5422	257	5559	71		
4762	175	5008	255	5072	42	5132	197	5315	263	5367	257	5423	257	5560	71		
4763	175	5009	255	5073	42	5133	197	5316	263	5368	257	5424	261	5561	71		
4800	177	5010	255	5074	42	5134	197	5317	264	5369	257	5425	261	5562	71		
4801	177	5011	255	5075	42	5150	194	5318	264	5371	246	5426	261	5563	71		
4802	177	5012	255	5076	43	5151	243	5319	264	5372	246	5427	261	5564	71		
4807	177	5013	255	5077	43	5152	243	5320	264	5373	246	5428	261	5565	70		
4809	178	5014	255	5078	43	5153	254	5321	253	5374	246	5450	257	5566	70		
4810	178	5015	255	5081	41	5154	254	5322	253	5375	246	5451	257	5569	70		
4811	178	5016	255	5082	41	5155	254	5323	253	5376	246	5452	257	5570	70		
4823	177	5017	255	5083	41	5157	254	5324	253	5377	247	5453	257	5571	70		
4825	177	5018	255	5084	41	5158	254	5325	253	5378	263	5455	268	5572	70		
4827	177	5019	255	5085	41	5159	254	5326	253	5379	263	5456	268	5573	70		
4839	177	5020	255	5086	41	5160	254	5327	253	5380	248	5457	268	5574	70		
4840	178	5021	255	5090	361	5162	195	5328	253	5381	248	5458	268	5575	70		
4841	178	5022	255	5091	361	5165	195	5329	253	5382	248	5459	268	5576	70		
4842	178	5023	255	5092	361	5166	195	5330	253	5383	250	5460	270	5577	70		
4843	178	5024	255	5093	361	5170	43	5331	253	5384	250	5461	137	5578	70		
4850	181	5025	255	5094	361	5171	43	5332	253	5385	250	5462	270	5579	70		
4851	181	5026	255	5095	361	5172	43	5334	265	5386	251	5463	270	5601	75		

SKU	Page No.	SKU	Page No.	SKU	Page No.	SKU	Page No.	SKU	Page No.	SKU	Page No.
5602	75	5738	271	5796	281	5915	283	6025	159	6203	212
5603	75	5739	271	5797	281	5916	283	6026	159	6206	212
5604	75	5741	276	5818	295	5917	283	6027	159	6207	212
5605	75	5742	276	5819	295	5918	283	6028	143	6208	212
5606	75	5743	276	5839	295	5919	283	6029	143	6211	213
5607	75	5744	276	5859	278	5920	283	6030	143	6212	213
5608	75	5745	276	5865	278	5921	283	6031	143	6213	213
5609	75	5746	276	5866	278	5922	283	6032	143	6214	213
5610	74	5747	277	5867	278	5923	283	6033	143	6221	213
5611	74	5748	277	5868	278	5924	283	6035	144	6222	213
5614	74	5749	277	5870	278	5925	283	6036	144	6224	213
5715	74	5750	277	5871	278	5926	283	6037	144	6231	214
5617	74	5751	290	5872	278	5927	283	6038	144	6232	214
5618	74	5752	290	5873	278	5928	283	6039	144	6233	214
5626	77	5753	290	5874	278	5929	283	6101	216	6241	214
5627	77	5754	291	5875	278	5930	284	6102	216	6242	214
5629	77	5755	291	5876	278	5931	284	6103	216	6243	214
5630	77	5756	291	5877	278	5932	284	6104	218	6251	215
5701	272	5760	274	5878	278	5933	284	6105	218	6252	215
5702	272	5761	274	5879	278	5934	284	6106	218	6253	215
5703	272	5762	274	5880	279	5935	284	6108	218	6254	215
5704	272	5763	274	5881	279	5936	284	6109	218	6261	215
5705	272	5764	274	5882	279	5937	284	6110	217	6262	215
5706	272	5765	274	5883	279	5938	284	6111	217	6263	215
5707	272	5766	274	5884	279	5939	284	6112	217	6264	215
5708	272	5767	274	5885	279	5940	284	6114	218	6271	210
5709	272	5768	274	5886	279	5941	285	6115	217	6272	210
5710	272	5769	274	5887	279	5942	285	6117	218	6273	210
5711	272	5770	274	5888	279	5943	285	6119	216	6281	210
5712	272	5771	275	5889	279	5944	285	6120	216	6282	210
5713	272	5772	275	5890	279	5945	285	6121	218	6283	210
5714	272	5773	275	5891	279	5946	285	6124	175	6284	211
5715	272	5774	275	5892	279	5947	285	6131	220	6285	211
5721	273	5775	275	5893	279	5948	285	6133	220	6302	224
5722	273	5776	275	5894	279	5949	285	6134	220	6303	224
5723	273	5777	275	5900	282	5950	285	6135	220	6304	224
5724	273	5778	275	5901	282	5952	287	6151	219	6305	225
5725	273	5779	275	5902	282	5953	287	6152	219	6306	224
5726	273	5780	275	5903	282	5954	287	6153	219	6307	224
5727	273	5781	275	5904	282	5955	287	6154	219	6308	226
5728	273	5786	280	5905	282	5956	287	6155	219	6310	225
5729	273	5787	280	5906	282	5957	287	6161	221	6311	225
5730	273	5788	280	5907	282	5958	287	6162	221	6312	226
5731	273	5789	280	5908	282	5959	287	6163	221	6314	226
5732	273	5790	280	5909	282	5960	287	6164	221	6315	226
5733	273	5791	280	5910	282	5961	287	6165	221	6317	227
5734	273	5792	281	5911	282	5962	287	6191	386	6318	227
5735	273	5793	281	5912	282	6019	144	6192	386	6319	227
5736	271	5794	281	5913	282	6020	144	6201	212	6320	227
5737	271	5795	281	5914	282	6022	144	6202	212	6326	225

SKU	Page No.	SKU	Page No.	SKU	Page No.	SKU	Page No.	SKU	Page No.	SKU	Page No.	SKU	Page No.	SKU	Page No.	SKU	Page No.
6328	225	6389	235	6639	203	6726	85	7318	368	7467	331						
6329	226	6390	233	6640	203	6731	78	7319	368	7468	331						
6331	189	6391	233	6641	297	6732	78	7320	366	7469	330						
6332	189	6392	233	6642	297	6733	79	7321	366	7470	330						
6340	236	6393	234	6643	297	6734	79	7322	369	7471	330						
6341	236	6394	234	6644	297	6735	78	7323	369	7472	330						
6342	237	6395	232	6645	297	6736	78	7401	340	7473	330						
6343	237	6396	233	6646	297	6737	79	7402	340	7474	330						
6344	236	6397	234	6647	296	6738	79	7403	327	7475	328						
6345	236	6501	296	6648	296	6739	78	7404	327	7476	328						
6346	236	6502	296	6671	83	6740	78	7405	345	7477	328						
6347	236	6503	296	6672	83	6741	79	7406	345	7478	328						
6348	228	6504	296	6673	83	6742	79	7422	340	7479	328						
6349	228	6505	296	6674	83	6745	82	7423	340	7480	328						
6350	229	6506	296	6675	83	6746	82	7431	342	7481	329						
6353	237	6507	296	6676	83	6747	82	7432	342	7482	329						
6354	241	6508	296	6677	83	6748	82	7433	342	7483	329						
6355	240	6509	297	6678	83	7121	321	7434	343	7484	329						
6356	241	6510	297	6679	83	7131	320	7435	343	7485	329						
6357	242	6511	297	6680	83	7132	320	7436	343	7486	329						
6358	242	6512	297	6681	83	7133	320	7437	342	7487	329						
6359	229	6601	202	6682	295	7134	320	7438	342	7488	333						
6360	229	6602	202	6683	295	7135	320	7439	342	7489	333						
6361	242	6603	202	6684	295	7136	320	7440	343	7490	333						
6362	242	6604	202	6685	295	7201	90	7441	343	7491	333						
6363	241	6605	202	6686	296	7202	90	7442	343	7492	333						
6364	238	6608	243	6687	296	7203	89	7443	341	7493	333						
6365	240	6610	243	6691	84	7204	89	7444	341	7494	333						
6366	238	6611	243	6692	84	7205	89	7445	341	7495	333						
6367	238	6612	243	6693	84	7206	89	7446	341	7496	333						
6368	229	6613	243	6694	84	7207	90	7447	341	7497	333						
6369	239	6614	243	6695	84	7208	91	7448	341	7498	333						
6370	240	6615	243	6697	84	7209	91	7449	342	7503	334						
6371	239	6616	243	6698	84	7210	91	7450	342	7504	334						
6372	239	6617	243	6701	80	7211	91	7451	332	7505	334						
6374	230	6618	243	6702	80	7301	364	7452	332	7506	334						
6375	230	6619	243	6703	81	7302	364	7453	332	7507	334						
6376	230	6620	243	6704	81	7304	370	7454	332	7508	334						
6377	230	6621	243	6705	80	7305	366	7455	332	7509	335						
6378	235	6622	182	6706	80	7306	365	7456	332	7510	335						
6379	231	6623	182	6707	81	7307	365	7457	332	7511	335						
6380	232	6624	182	6708	81	7309	370	7458	332	7512	335						
6381	231	6631	204	6709	80	7310	367	7459	332	7513	335						
6382	231	6632	204	6710	80	7311	367	7460	332	7514	335						
6383	232	6633	204	6711	81	7312	373	7461	332	7515	336						
6384	232	6634	203	6712	81	7313	372	7462	332	7516	336						
6385	235	6635	203	6721	85	7314	373	7463	331	7517	336						
6386	228	6636	203	6722	85	7315	371	7464	331	7518	336						
6387	228	6637	203	6724	85	7316	371	7465	331	7519	336						
6388	231	6638	203	6725	85	7317	366	7466	331	7520	336						

SKU	Page No.	SKU	Page No.	SKU	Page No.	SKU	Page No.	SKU	Page No.
7521	337	8192	310	9050	62	9172	307	9331	346
7522	337	8201	312	9051	62	9173	307	9332	346
7523	337	8202	312	9052	62	9174	307	9333	346
7524	337	8203	312	9053	62	9175	309	9334	347
7525	337	8204	312	9054	62	9176	309	9335	347
7526	327	8205	312	9055	62	9177	309	9336	347
7527	327	8206	312	9056	62	9178	309	9337	348
7528	326	8207	312	9057	62	9179	304	9338	348
7529	326	8208	312	9058	63	9180	304	9339	348
7530	326	8209	313	9059	63	9181	308	9340	349
7531	326	8210	313	9060	63	9182	308	9341	349
7532	326	8211	313	9061	63	9196	305	9342	349
7533	326	8212	313	9062	64	9197	305	9500	418
7534	326	8213	313	9063	64	9198	305	9501	418
7535	326	8214	313	9064	64	9199	305	9502	418
8126	311	8215	313	9065	64	9201	303	9503	418
8140	311	8216	313	9066	64	9202	303	9504	420
8141	311	8217	313	9067	65	9203	303	9506	419
8151	318	8218	313	9068	65	9204	303	9507	419
8152	318	9002	121	9069	65	9205	303	9508	418
8153	318	9003	121	9070	65	9206	303	9509	418
8154	318	9004	121	9071	65	9207	303	9510	419
8155	318	9005	121	9072	60	9208	303	9511	419
8156	318	9008	122	9073	60	9209	303	9512	419
8157	318	9009	122	9074	61	9210	303	9513	419
8158	318	9011	122	9075	61	9211	303	9514	420
8166	314	9013	122	9076	60	9212	303	9515	420
8167	314	9014	122	9077	60	9213	303	9516	420
8168	314	9015	123	9078	61	9214	303	5611-m216	
8169	314	9016	123	9079	61	9215	303	5612-m216	
8170	314	9017	124	9080	66	9301	350	5613-m218	
8171	314	9018	124	9081	66	9302	350	5623-m175	
8172	314	9019	125	9082	66	9303	350	5624-m220	
8173	314	9020	125	9083	66	9304	350	5643-m220	
8174	315	9021	125	9084	67	9305	351		
8175	315	9022	126	9085	67	9306	351		
8176	315	9023	126	9086	67	9307	351		
8177	315	9024	126	9087	67	9308	351		
8178	315	9025	127	9126	302	9309	352		
8179	315	9026	127	9127	302	9310	352		
8180	315	9027	120	9128	302	9311	352		
8181	315	9036	118	9129	302	9312	352		
8182	316	9037	118	9135	300	9313	353		
8183	316	9038	119	9136	300	9314	353		
8184	316	9039	119	9137	301	9315	353		
8185	317	9041	128	9138	301	9316	353		
8186	317	9042	128	9156	306	9321	345		
8187	317	9043	129	9157	306	9322	345		
8190	310	9044	129	9158	306	9323	345		
8191	310	9045	129	9171	307	9324	345		

OPTONICA

LED Lighting for everyone

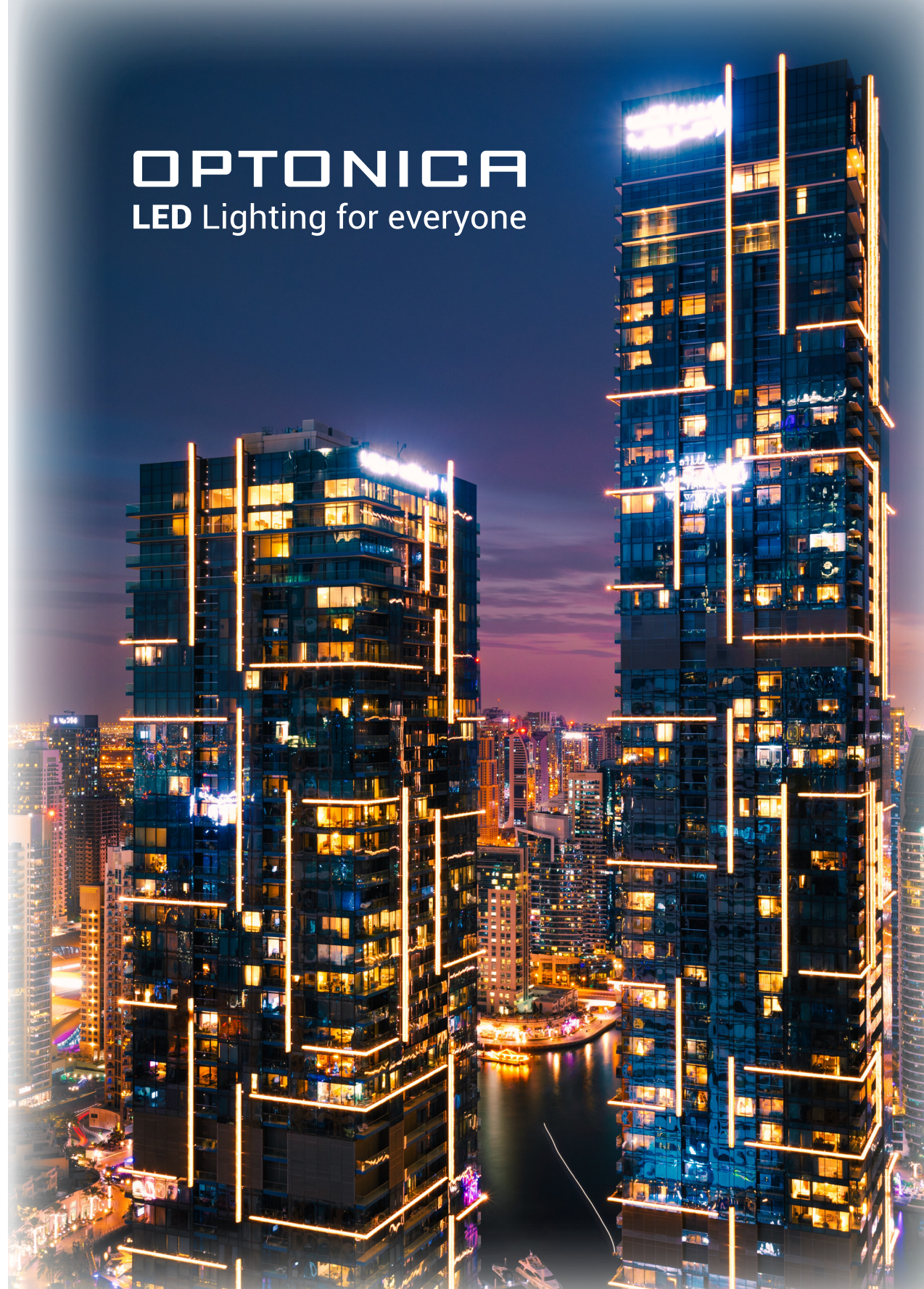

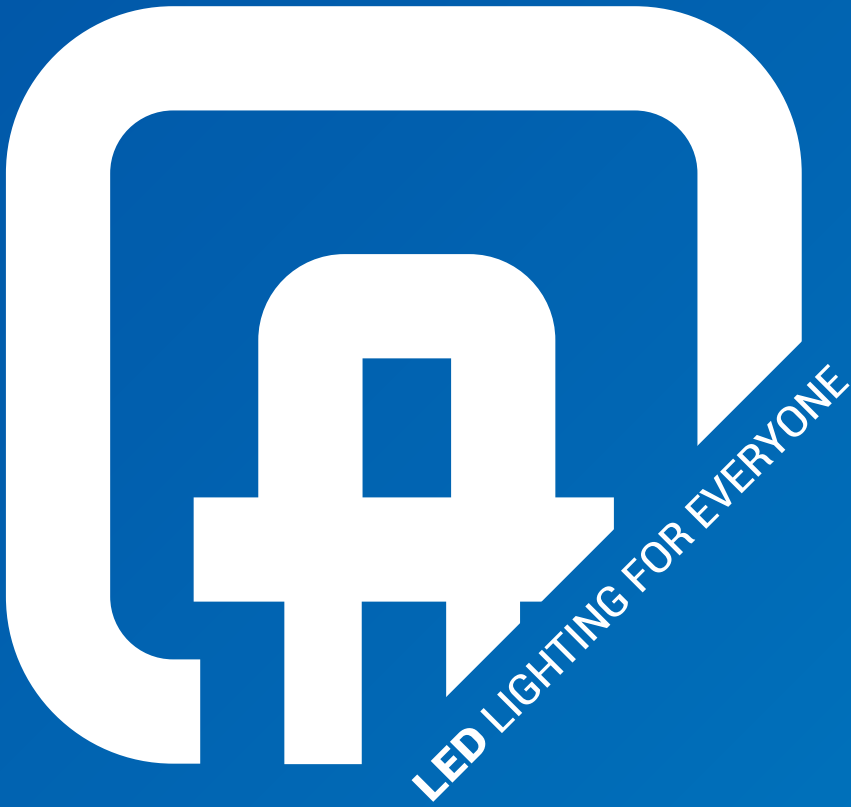

www.optonicaled.com